



**WILSONVILLE
OREGON**

29799 SW Town Center Loop E, Wilsonville, OR 97070
Phone: 503.682.4960 Fax: 503.682.7025
Web: www.ci.wilsonville.or.us

**Planning Division
Development Permit Application**

Final action on development application or zone change is required within 120 days per ORS 227.175 or as otherwise required by state or federal law for specific application types.

A pre application conference may be required.

The City will not accept applications for wireless communication facilities or similar facilities without a completed copy of a Wireless Facility Review Worksheet.

The City will not schedule incomplete applications for public hearing or send administrative public notice until all of the required materials are submitted.

Applicant:

Name: Inland Pacific Properties LLC c/o Darin Coder
Company: Inland Pacific Properties LLC
Mailing Address: 30170 SW OrePac Avenue
City, State, Zip: Wilsonville, OR 97070
Phone: _____ Fax: _____
E-mail: _____

Authorized Representative:

Name: Sid Hariharan Godt
Company: Mackenzie
Mailing Address: 1515 SE Water Avenue
City, State, Zip: Portland, OR 97202
Phone: (971) 346-3700 Fax: _____
E-mail: sh@mcknze.com

Property Owner:

Name: Inland Pacific Properties LLC c/o Darin Coder
Company: Inland Pacific Properties LLC
Mailing Address: 30170 SW OrePac Avenue
City, State, Zip: Wilsonville, OR 97070
Phone: _____ Fax: _____
E-mail: _____

Property Owner's Signature:

Printed Name: DARIN A. CODER Date: 1-5-24

Applicant's Signature: (if different from Property Owner)

Printed Name: _____ Date: _____

Site Location and Description:

Project Address if Available: 30170 SW OrePac Avenue Suite/Unit _____
Project Location: _____
Tax Map #(s): _____ Tax Lot #(s): _____ County: Washington Clackamas

Request:

Please see attached narrative and supporting materials for detailed request.

Project Type: Class I **Class II** **Class III**

Residential Commercial Industrial Other: _____

Application Type(s):

- | | | | |
|--|---|---|---|
| <input type="checkbox"/> Annexation | <input type="checkbox"/> Appeal | <input type="checkbox"/> Comp Plan Map Amend | <input type="checkbox"/> Parks Plan Review |
| <input type="checkbox"/> Final Plat | <input type="checkbox"/> Major Partition | <input type="checkbox"/> Minor Partition | <input type="checkbox"/> Request to Modify Conditions |
| <input type="checkbox"/> Plan Amendment | <input type="checkbox"/> Planned Development | <input type="checkbox"/> Preliminary Plat | <input checked="" type="checkbox"/> Site Design Review |
| <input type="checkbox"/> Request for Special Meeting | <input type="checkbox"/> Request for Time Extension | <input type="checkbox"/> Signs | <input checked="" type="checkbox"/> Stage II Final Plan |
| <input type="checkbox"/> SROZ/SRIR Review | <input type="checkbox"/> Staff Interpretation | <input checked="" type="checkbox"/> Stage I Master Plan | <input type="checkbox"/> Variance |
| <input type="checkbox"/> Type C Tree Removal Plan | <input type="checkbox"/> Tree Permit (B or C) | <input type="checkbox"/> Temporary Use | <input checked="" type="checkbox"/> Other (describe) |
| <input type="checkbox"/> Villebois SAP | <input type="checkbox"/> Villebois PDP | <input type="checkbox"/> Villebois FDP | |
| <input checked="" type="checkbox"/> Zone Map Amendment | <input type="checkbox"/> Waiver(s) | <input type="checkbox"/> Conditional Use | |

**ZONE MAP AMENDMENT
STAGE I PRELIMINARY
PLAN
STAGE II FINAL PLAN
SITE DESIGN REVIEW
LOT LINE ADJUSTMENT
RIGHT-OF-WAY
VACATION
TYPE C TREE REMOVAL
PERMIT**

To

City of Wilsonville

For

OrePac – Site Improvements

Dated

January 8, 2024

(Revised June 20, 2024)

(Revised July 12, 2024)

Project Number

2220061.00





TABLE OF CONTENTS

I.	PROJECT SUMMARY	1
II.	INTRODUCTION	2
	Existing Site and Surrounding Land Use	2
	Description of Request	3
III.	RIGHT OF WAY NARRATIVE AND COMPLIANCE	6
	Wilsonville Development Code Section 4.031	6
	Oregon Revised Statute 271: Use and Disposition of Public Lands	6
IV.	NARRATIVE AND COMPLIANCE	10
	Section 4.117. Standards Applying To Industrial Developments In Any Zone	10
	Section 4.118. Standards Applying to all Planned Development Zones	10
	Section 4.120. - Zones. FDA-H Future Development Agricultural—Holding Zone.	13
	Section 4.135. - PDI—Planned Development Industrial Zone.	14
	Section 4.140. Planned Development Regulations	18
	Section 4.139.00. - Significant Resource Overlay Zone (SROZ) Ordinance.	26
	Site Design Review	30
	Section 4.154. On-site Pedestrian Access and Circulation	30
	Section 4.155. General Regulations - Parking, Loading and Bicycle Parking	32
	Section 4.171. General Regulations - Protection of Natural Features and Other Resources	38
	Section 4.175. Public Safety and Crime Prevention	43
	Section 4.176. Landscaping, Screening, and Buffering	43
	Section 4.177. Street Improvement Standards	53
	Section 4.179. Mixed Solid Waste and Recyclables Storage in New Multi-Unit Residential and Non-Residential Buildings	60
	Section 4.197 Zone Changes and Amendments to This Code – Procedures	60
	Section 4.199 Outdoor Lighting	62
	Section 4.199.10 Outdoor Lighting in General	62
	Section 4.199.20. Applicability	63
	Section 4.199.30. Lighting Overlay Zones	64
	Section 4.199.40. Lighting Systems Standards for Approval.	64
	Section 4.199.50. Submittal Requirements.	67
	Section 4.199.60. Major Additions or Modifications to Pre-Existing Sites.	70
	LAND DIVISIONS	72
	Section 4.200. General Purpose	72
	Section 4.202. General Authorization	72
	Section 4.233 Lot Line Adjustments	73
	Section 4.236 General Requirements – Streets	74
	Section 4.237 General Requirements – Other	75
	Section 4.250 Lots of Record	78
	Section 4.260 Improvements – Procedures	78
	Section 4.262 Improvements – Requirements	78
	Section 4.264 Improvements – Assurance	79
	Section 4.270 Variance from Land Division Standards	79
	UNDERGROUND UTILITIES	79
	Section 4.300. General	79
	Section 4.310. Exceptions	80

Section 4.320. Requirements.....	80
Section 4.400. Purpose	80
Section 4.420. Jurisdiction and Powers of the Board	81
Section 4.421. Criteria and Application of Design Standards	82
Section 4.430. Location, Design and Access Standards for Mixed Solid Waste and Recycling Areas	84
Section 4.440. Procedure.....	84
Section 4.441. Effective Date of Decisions.....	85
Section 4.442. Time Limit on Approval	85
Section 4.443. Preliminary Consideration	85
Section 4.450. Installation of Landscaping	86
Type C Tree Plan Review	86
Section 4.600 Purpose and Declaration.....	86
Section 4.600.20. Applicability of Subchapter.....	87
Section 4.600.30. Tree Removal Permit Required	87
Section 4.600.40. Exceptions.....	87
Section 4.600.50. Application For Tree Removal Permit.....	88
Section 4.610.00. Application Review Procedure	88
Section 4.620.00. Tree Relocation, Mitigation, Or Replacement	93
Section 4.620.10. Tree Protection During Construction.....	94
Section 4.630.00. Appeal.....	95
Section 4.640.00. Violation; Enforcement	96
V. CONCLUSION.....	98

EXHIBITS

- A. Application Form
- B. Aerial Map
- C. Zoning Map
- D. Survey
- E. Plan Set
- F. Preliminary Storm Report including Preliminary Geotechnical Report
- G. Lighting Plan
- H. Lighting Fixture Data Sheets
- I. City of Wilsonville Engineering Department – Pre-Application Meeting Notes
- J. Urban Renewal Agency Resolution No. 262
- K. Urban Renewal Agency Resolution No. 280
- L. Title Report
- M. Arborist Report
- N. Legal Description and Map for Property Line Adjustment
- O. Legal Description and Map for Zone Map Amendment
- P. Legal Description, Map, and Petition for Right-of-Way Vacation



I. PROJECT SUMMARY

Applicant/Owner:	Inland Empire Investments Inland Pacific Properties c/o: Darin Coder, CFO 30170 SW OrePac Avenue Wilsonville, OR 97070
Site Address:	30160 SW OrePac Avenue, Wilsonville, OR 97070 Clackamas County tax lots 31W2300780, 31W23B00690, 31W23B00600, 31W23B00700, 31W23B00701, 31W23B00680, 31W23B00791, 31W23BD00300, 31W23BD00101, and 31W23BD00200.
Assessor Site Acreage:	25.62 AC (1,116,007 SF)
Zoning:	Planned Development Industrial (PDI), Future Development Agricultural Holding (FDAHI) zone.
Comprehensive Plan:	Industrial
Adjacent Zoning:	<u>North:</u> Planned Development Industrial (PDI) <u>South:</u> Future Development Agricultural Holding – Industrial (FDAHI) <u>East:</u> Portland & Western Railroad (with Planned Development Industrial (PDI), Planned Development Commercial (PDC), and Future Development Agricultural Holding Commercial (FDAHC) east of the Railroad corridor) <u>West:</u> Planned Development Industrial (PDI)
Existing Structures:	OrePac Building
Request:	The applicant requests approval of the following applications: Zone Map Amendment Stage I Preliminary Plan State II Final Plan Site Design Review Lot Line Adjustment Right-of-Way Vacation Type C Tree Removal Permit
Project Contact:	Mackenzie Sid Hariharan Godt Land Use Planner 1515 SE Water Avenue, Suite 100 Portland, OR 97214 (971) 346-3700 sh@mcknze.com

II. INTRODUCTION

Per aerial imagery, between 2015-2017, the parking area south of the approved OrePac building and storage area (i.e., the parking area that is the subject of this application) was constructed without the required land use approvals. This application seeks to gain the appropriate set of land use approvals for the already constructed parking area, along with constructing new driveway, landscaping, stormwater facilities, and lighting improvements to meet applicable Code standards.

Existing Site and Surrounding Land Use

As the OrePac site encompasses many tax lots, below are the terms that will be used throughout this narrative. The term is in bold, with the term definition to follow.

Ownership: All contiguous properties under the ownership/control of the applicant. This includes tax lots 31W2300780, 31W23B00690, 31W23B00600, 31W23B00700, 31W23B00701, 31W23B00680, 31W23B00791, 31W23BD00300, 31W23BD00101, and 31W23BD00200.

Subject Property: This includes tax lots 101, 200, 300, 680, 690, and 791. Note that tax lots 680, 690, and 791 are not deed lots but are functions of past Urban Renewal actions. The applicant believes TL 680, 690, and 791 were created by the Clackamas County Assessor specifically for application of special property tax assessment rules/rates that apply within urban renewal districts, and they have no effect on deed ownership boundaries or applicability of Wilsonville land use regulations.

Urban Renewal-Related Tax Lots: Portions of overlaid tax lot boundaries within the Proposed ZMA/PD Subarea (a.k.a. “**Subject Property**”) (i.e., tax lots 680, 690, 791); these appear on tax maps for tax assessment purposes, but they do NOT correspond to fee ownership boundaries and have no effect on the proposed land use actions.

Property Line Adjustment Parcels: The common boundary line between tax lots 101 and 600 (both of which are deed lots) is being adjusted. This action affects portions of tax lots 680, 690, and 791, as well as the proposed ROW vacation area.

ROW Vacation Area: The 31' wide east-west corridor south of TL 791 that was previously dedicated as public right-of-way.

Excluded Parcels: TL 21W 23BD 200 and 300 are located at the south boundary of the Ownership area are included as part of the zone change request, but no other applications of this consolidated land use package.

As shown on the Zoning Map (Exhibit C), the area to the south is zoned Future Development Agricultural Holding – Industrial (FDAHI), the area to the north is zoned Planned Development Industrial (PDI), the area to the east is the Portland & Western Railroad (with Planned Development Industrial (PDI), Planned Development Commercial (PDC), and Future Development Agricultural Holding Commercial (FDAHC) located east of the Railroad corridor), and the area to the west is zoned Planned Development Industrial (PDI). None of these zones is a residential district, so this standard does not apply, and no parking lot screening is required under this provision.

Description of Request

The Applicant is requesting the following approvals as part of this consolidated land use application package:

Zone Map Amendment

A Zone Map Amendment is requested to change the zoning of adjusted tax lots 101, 200, and 300 from Future Development Agricultural Holding – Industrial (FDAHI) to Planned Development Industrial (PDI). The purpose of the requested Zone Map Amendment is to enable development of the Subject Property consistent with the request herein.

Stage I Preliminary Plan, Stage II Final Plan, and Site Design Review

This application includes detailed plans and descriptions for the legalization of the existing parking area, as well as a new driveway, landscaping, stormwater facilities, and lighting. This proposal includes a development plan that is consistent with the site’s land use designation on the Comprehensive Plan. As part of the site development, an existing stockpile will be partially graded to accommodate a future potential building. Any future building would be the subject of a future land use application.

Lot Line Adjustment

The Applicant proposes a lot line adjustment (LLA) to adjust the shared lot line of tax lots 600 and 101. The purpose of the lot line adjustment is to realign the deed ownership boundary with the limits of the proposed zone change. The lot line adjustment will adjust the boundary line between tax lot 600 and tax lot 101. Approximately 271,322 SF will be transferred from tax lot 600 to tax lot 101 through the lot line adjustment process. This application includes a diagram showing the feasibility of the requested LLA, along with evidence presented in this narrative demonstrating compliance with applicable standards.

Right-of-Way Vacation

This application includes a request to vacate a segment of public right of way located in the central portion of the site. In previous City actions affecting the subject property, Urban Renewal Agency Resolution No. 262 (2016) identified a section of property (see Sheet 11 of 14, of Exhibit J) as a possible alignment for a road connection from Bailey Street to Kinsman Road. Urban Renewal Agency Resolution No. 262 was subsequently amended by URA Resolution No. 280 (10th Amendment to the Year 2000 Plan). The 10th Amendment to the Year 2000 Plan boundary change clarified the location of the new east-west connector based on the City Council decision that it be a 5th Street extension and not a Bailey Street extension. As a result, the existing dedicated public right-of-way (which was dedicated in 1990 by Partition Plat No. 1990-92) is now redundant.

Type C Tree Removal Permit

Existing trees are proposed for removal as part of the proposed development, to accommodate the proposed driveway. Seven (7) trees with a 6" or greater d.b.h. are proposed for removal as part of the site improvements. Seven (7) mitigation trees are proposed to be planted as part of the site improvements. This standard is met.



Figure 1: Aerial Image



Figure 2: 2024 Land Use Action

Please note, areas that are labeled “2024 Action” are part of the “Subject Property.”

III. RIGHT OF WAY NARRATIVE AND COMPLIANCE

Wilsonville Development Code Section 4.031

(.01) *As specified in Chapter 2 of the Wilsonville Code and except as specified herein, the Board shall have authority to act on the following types of applications:*

- L. *Street vacations, where a specific development application has been filed for the subject property. If no specific development has been filed for the subject property, the vacation request shall be considered by the Planning Commission. Action of the Planning Commission or Board on a street vacation request shall be a recommendation to the City Council.*

Response: Vacation of “Tract A” as described in in Exhibit P is included as part of this development application. The proposed ROW vacation is subject to review by the DRB, which will make a recommendation to City Council.

4.033 Authority of the Council

(.01) *Upon appeal, the City Council shall have final authority to act on all applications filed pursuant to Chapter 4 of the Wilsonville Code, with the exception of applications for expedited land divisions, as specified in Section 4.232. Additionally, the Council shall have final authority to interpret and enforce the procedures and standards set forth in this Chapter and shall have final decision-making authority on the following:*

- H. *Final actions on street vacation applications.*

Response: As described above in the applicant’s response to Section 4.031, the proposed street vacation is subject to initial review by the Development Review Board with the City Council having final decision-making authority on the requested Right of Way Vacation.

4.034 Application Requirements

Applications shall be reviewed as follows:

(.07) *Applications for street vacations shall be reviewed in accordance with the standards and procedures set forth in ORS 271.*

Response: Compliance with the applicable sections of ORS 271 is addressed below, with evidence provided in Exhibit P. This standard is met.

Oregon Revised Statute 271: Use and Disposition of Public Lands

271.080 Vacation in incorporated cities; petition; consent of property owners.

(1) *Whenever any person interested in any real property in an incorporated city in this state desires to vacate all or part of any street, avenue, boulevard, alley, plat, public square or other public place, such person may file a petition therefor setting forth a description of the ground proposed to be vacated, the purpose for which the ground is proposed to be used and the reason for such vacation.*

(2) *There shall be appended to such petition, as a part thereof and as a basis for granting the same, the consent of the owners of all abutting property and of not less than two-thirds in area of the real property affected thereby. The real property affected thereby shall be deemed to be the land lying on either side of the street or portion thereof proposed to be vacated and extending laterally to the next street that serves*

as a parallel street, but in any case not to exceed 200 feet, and the land for a like lateral distance on either side of the street for 400 feet along its course beyond each terminus of the part proposed to be vacated. Where a street is proposed to be vacated to its termini, the land embraced in an extension of the street for a distance of 400 feet beyond each terminus shall also be counted. In the vacation of any plat or part thereof the consent of the owner or owners of two-thirds in area of the property embraced within such plat or part thereof proposed to be vacated shall be sufficient, except where such vacation embraces street area, when, as to such street area the above requirements shall also apply. The consent of the owners of the required amount of property shall be in writing. [Amended by 1999 c.866 §2]

Response: This application is a petition for a vacation of Right of Way as described on the enclosed legal description and sketch (Exhibit P). This application includes a request to vacate a segment of public right of way located in the central portion of the site. In previous City actions affecting the subject property, Urban Renewal Agency Resolution No. 262 (2016) identified a section of property (see Sheet 11 of 14, of Exhibit J) as a possible alignment for a road connection from Bailey Street to Kinsman Road. Urban Renewal Agency Resolution No. 262 was subsequently amended by URA Resolution No. 280 (10th Amendment to the Year 2000 Plan). The 10th Amendment to the Year 2000 Plan boundary change clarified the location of the new east-west connector based on the City Council decision that it be a 5th Street extension and not a Bailey Street extension. As a result, the existing dedicated public right-of-way (which was dedicated in 1990 by Partition Plat No. 1990-92) is now redundant. Exhibit P contains a copy of the signed petition with attached map and list that identifies the area of the proposed ROW vacation, abutting property owners and real property affected thereby. The petition has been signed by all owners of the abutting property and by property owners who comprise at least 2/3 of the real property affected. As the petition has been signed by all abutting property owners, consent by at least 2/3 of the real property affected of the real property has been provided. This standard is met.

271.120 Hearing; determination.

At the time fixed by the governing body for hearing the petition and any objections filed thereto or at any postponement or continuance of such matter, the governing body shall hear the petition and objections and shall determine whether the consent of the owners of the requisite area has been obtained, whether notice has been duly given and whether the public interest will be prejudiced by the vacation of such plat or street or parts thereof. If such matters are determined in favor of the petition the governing body shall by ordinance make such determination a matter of record and vacate such plat or street; otherwise it shall deny the petition. The governing body may, upon hearing, grant the petition in part and deny it in part, and make such reservations, or either, as appear to be for the public interest.

Response: The applicant understands the governing body shall hear the petition and objections, if any, to determine whether requirements for the proposed street vacation have been satisfied. Compliance with ORS 271.080 is discussed above. The signed petition, legal description, and accompanying sketch are included as Exhibit P. This standard is met.

271.140 Title to vacated areas.

The title to the street or other public area vacated shall attach to the lands bordering on such area in equal portions; except that where the area has been originally dedicated by different persons and the fee title to such area has not been otherwise disposed of, original boundary lines shall be adhered to and the street area which lies on each side of such boundary line shall attach to the abutting property on such side. If a public square is vacated the title thereto shall vest in the city. [Amended by 1981 c.153 §58]

Response: The applicant understands that as the right-of-way was dedicated to the City as part of Partition Plat #1990-92, the to-be vacated right-of-way area "Tract A" will be returned to Parcel 2 of Partition Plat #1990-92.

271.150 Vacation records to be filed; costs.

A certified copy of the ordinance vacating any street or plat area and any map, plat or other record in regard thereto which may be required or provided for by law, shall be filed for record with the county clerk. The petitioner for such vacation shall bear the recording cost and the cost of preparing and filing the certified copy of the ordinance and map. A certified copy of any such ordinance shall be filed with the county assessor and county surveyor.

Response: Oregon Revised Statute (ORS) addresses the final ordinance procedure and accompanying filing and recording process. The applicant acknowledges that the petitioner is responsible for the recording and filing costs. When the final ordinance is prepared, the applicant/petitioner will file the copy of ordinance with the Clackamas County assessor and surveyor.

271.190 Consent of owners of adjoining property; other required approval.

No vacation of all or part of a street, alley, common or public place shall take place under ORS 271.180 unless the consent of the persons owning the property immediately adjoining that part of the street or alley to be vacated is obtained thereto in writing and filed with the auditor or clerk of the city or town. No vacation shall be made of any street, alley, public place or part thereof, if within 5,000 feet of the harbor or pierhead line of the port, unless the port commission, or other bodies having jurisdiction over docks and wharves in the port district involved, approves the proposed vacation in writing.

Response: Compliance with ORS 271.080 is addressed above. The area of the proposed ROW vacation is not within 5,000' of a harbor or pierhead line of a port. This standard is met.

271.200 Petition; notice.

(1) Before any street, alley, common or public place or any part thereof is vacated, or other right granted by any city governing body under ORS 271.180 to 271.210 the applicant must petition the governing body of the city or town involved, setting forth the particular circumstances of the case, giving a definite description of the property sought to be vacated, or of the right, use or occupancy sought to be obtained, and the names of the persons to be particularly affected thereby. The petition shall be filed with the auditor or clerk of the city or town involved 30 days previous to the taking of any action thereon by the city governing body.

(2) Notice of the pendency of the petition, containing a description of the area sought to be vacated or right, use or occupancy sought to be obtained, shall be published at least once each week for three successive weeks prior to expiration of such 30-day period in a newspaper of general circulation in the county wherein the city or town is located.

Response: This application serves as a petition to the City of Wilsonville to vacate "Tract A" as described in Exhibit P. In previous City actions affecting the subject property, Urban Renewal Agency Resolution No. 262 (2016) identified a section of property (see Sheet 11 of 14, of Exhibit J) as a possible alignment for a road connection from Bailey Street to Kinsman Road. Urban Renewal Agency Resolution No. 262 was subsequently amended by URA Resolution No. 280 (10th Amendment to the Year 2000 Plan). The 10th Amendment to the Year 2000 Plan boundary change clarified the location of the new east-west connector based on the City Council decision that it be a 5th Street extension and not a Bailey Street extension. As a result, the existing dedicated public right-of-way (which was dedicated in 1990 by Partition Plat No. 1990-92) is now redundant. Exhibit P contains a copy of the signed petition with attached map and list that identifies the area of the proposed ROW vacation, abutting property owners and real property affected thereby. The petition has been signed by all owners of the abutting property and by property owners who comprise at least 2/3 of the real property affected. As the petition has been signed by all abutting property

owners, consent by at least 2/3 of the real property affected of the real property has been provided. This standard is met.

IV. NARRATIVE AND COMPLIANCE

Section 4.117. Standards Applying To Industrial Developments In Any Zone

(.01) *All industrial developments, uses, or activities are subject to performance standards. If not otherwise specified in the Planning and Development Code, industrial developments, uses, and activities shall be subject to the performance standards specified in Section 4.135 (.05) (PDI Zone).*

Response: The proposed development includes a parking area to serve an existing industrial use, new driveway accessing SW 5th Street with associated landscaping, stormwater facilities, and lighting. The applicant has demonstrated compliance with the performance standards in the responses to 4.135.05 herein. This standard is met.

Section 4.118. Standards Applying to all Planned Development Zones

(.01) *Height Guidelines: In “S” overlay zones, the solar access provisions of Section 4.137 shall be used to determine maximum building heights. In cases that are subject to review by the Development Review Board, the Board may further regulate heights as follows:*

- A. *Restrict or regulate the height or building design consistent with adequate provision of fire protection and fire-fighting apparatus height limitations.*
- B. *To provide buffering of low density developments by requiring the placement of three or more story buildings away from the property lines abutting a low density zone.*
- C. *To regulate building height or design to protect scenic vistas of Mt. Hood or the Willamette River.*

Response: The proposal is not located in an “S” overlay zone. This standard does not apply.

(.02) *Underground Utilities shall be governed by Sections 4.300 to 4.320. All utilities above ground shall be located so as to minimize adverse impacts on the site and neighboring properties.*

Response: All underground utilities will comply with City of Wilsonville standards as detailed in the responses to Sections 4.300 to 4.320, below.

(.03) *Notwithstanding the provisions of Section 4.140 to the contrary, the Development Review Board, in order to implement the purposes and objectives of Section 4.140, and based on findings of fact supported by the record may:*

Response: No Waivers are requested as part of this proposal.

- B. *The following shall not be waived by the Board, unless there is substantial evidence in the whole record to support a finding that the intent and purpose of the standards will be met in alternative ways:*
 1. *open space requirements in residential areas...;*
 2. *minimum density standards of residential zones...;*
 3. *minimum landscape, buffering, and screening standards;*

Response: Not applicable; this proposal is not located in a residential area and the applicant is not proposing waivers to these standards.

- C. *The following shall not be waived by the Board, unless there is substantial evidence in the whole record to support a finding that the intent and purpose of the standards will be met in alternative ways, and the action taken will not violate any applicable federal, state, or regional standards:*
 1. *maximum number of parking spaces;*
 2. *standards for mitigation of trees that are removed;*
 3. *standards for mitigation of wetlands that are filled or damaged; and*
 4. *trails or pathways shown in the Parks and Recreation Master Plan.*

Response: Not applicable; the applicant is not proposing waivers to these standards.

D. Locate individual building, accessory buildings, off-street parking and loading facilities, open space and landscaping and screening without reference to lot lines; and

Response: As shown in Exhibit E, the applicant is proposing parking areas, landscape areas, and a driveway that complies with the applicable setback standards. The applicant is not requesting different setbacks as part of the Planned Development application. This standard does not apply.

E. Adopt other requirements or restrictions, inclusive of, but not limited to, the following:

- 1. Percent coverage of land by buildings and structures in relationship to property boundaries to provide stepped increases in densities away from low-density development.*
- 2. Parking ratios and areas expressed in relation to use of various portions of the property and/or building floor area.*
- 3. The locations, width and improvement of vehicular and pedestrian access to various portions of the property, including portions within abutting street or private drive. [amended by Ord. 682, 9/9/10]*
- 4. Arrangement and spacing of buildings and structures to provide appropriate open spaces around buildings.*
- 5. Location and size of off-street loading areas and docks.*
- 6. Uses of buildings and structures by general classification, and by specific designation when there are unusual requirements for parking, or when the use involves noise, dust, odor, fumes, smoke, vibration, glare or radiation incompatible with present or potential development of surrounding property. Such incompatible uses may be excluded in the amendment approving the zone change or the approval of requested permits.*
- 7. Measures designed to minimize or eliminate noise, dust, odor, fumes, smoke, vibration, glare, or radiation which would have an adverse effect on the present or potential development on surrounding properties.*
- 8. Schedule of time for construction of the proposed buildings and structures and any stage of development thereof to insure consistency with the City's adopted Capital Improvements Plan and other applicable regulations.*
- 9. A waiver of the right of remonstrance by the applicant to the formation of a Local Improvement District (LID) for streets, utilities and/or other public purposes.*
- 10. Modify the proposed development in order to prevent congestion of streets and/or to facilitate transportation.*
- 11. Condition the issuance of an occupancy permit upon the installation of landscaping or upon a reasonable scheduling for completion of the installation of landscaping. In the latter event, a posting of a bond or other security in an amount equal to one hundred ten percent (110%) of the cost of the landscaping and installation may be required.*
- 12. A dedication of property for streets, pathways, and bicycle paths in accordance with adopted Facilities Master Plans or such other streets necessary to provide proper development of adjacent properties.*

Response: The applicant acknowledges that the Development Review Board may impose other requirements or restrictions, including but not limited to those specified above; however, given the nature of the new parking area to serve an existing industrial use, new driveway accessing SW 5th Street, and associated landscaping, stormwater, and lighting, the applicant believes it is unnecessary to impose special restrictions or conditions of approval on the development.

(.04) *The Planning Director and Development Review Board shall, in making their determination of compliance in attaching conditions, consider the effects of this action on availability and cost. The provisions of this section shall not be used in such a manner that additional conditions, either singularly or cumulatively, have the effect of unnecessarily increasing the cost of development. However, consideration of these factors shall not prevent the Board from imposing conditions of approval necessary to meet the minimum requirements of the Comprehensive Plan and Code.*

Response: The applicant acknowledges that the Development Review Board must consider the effects of availability and cost when considering the attachment of conditions as described in Section 4.118 of the WDC. If imposition of conditions depends on consideration of cost factors, the applicant will participate in development cost estimates to inform that discussion; however, the applicant is not aware of any such issues at the time of submitting a complete application package.

(.05) *The Planning Director, Development Review Board, or on appeal, the City Council, may as a condition of approval for any development for which an application is submitted, require that portions of the tract or tracts under consideration be set aside, improved, conveyed or dedicated for the following uses:*

- A. *Recreational Facilities: The Director, Board, or Council, as the case may be, may require that suitable area for parks or playgrounds be set aside, improved or permanently reserved for the owners, residents, employees or patrons of the development consistent with adopted Park standards and Parks and Recreation Master Plan.*
- B. *Open Space Area: Whenever private and/or common open space area is provided, the City shall require that an association of owners or tenants be established which shall adopt such Articles of Incorporation, By-Laws or other appropriate agreement, and shall adopt and impose such Declaration of Covenants and Restrictions on such open space areas and/or common areas that are acceptable to the Development Review Board. Said association shall be formed and continued for the purpose of maintaining such open space area. Such an association, if required, may undertake other functions. It shall be created in such a manner that owners of property shall automatically be members and shall be subject to assessments levied to maintain said open space area for the purposes intended. The period of existence of such association shall be not less than twenty (20) years and it shall continue thereafter and until a majority vote of the members shall terminate it, and the City Council formally votes to accept such termination.*
- C. *Easements: Easements necessary to the orderly extension of public utilities, and the protection of open space, may be required as a condition of approval. When required, such easements must meet the requirements of the City Attorney prior to recordation.*

Response: The applicant acknowledges that the Planning Director and Development Review Board have this authority; however, establishment of recreational facilities or open space areas would be inconsistent with the City's planning for industrial use of this property.

Regarding the need for public utility easements, this application includes a request for vacation of the public right of way located in the central portion of the site. In previous City actions affecting the subject property, Urban Renewal Agency Resolution No. 262 (2016) identified a section of property (see Sheet 11 of 14, of Exhibit J) as a possible alignment for a road connection from Bailey Street to Kinsman Road. Urban Renewal Agency Resolution No. 262 was subsequently amended by URA Resolution No. 280 (10th Amendment to the Year 2000 Plan). The 10th Amendment to the Year 2000 Plan boundary change clarified the location of the new east-west connector based on the City Council decision that it be a 5th Street extension and not a Bailey Street extension.

As evidenced in the City's Pre-Application Engineering Division notes in Exhibit I, existing public utilities capable of serving the area are located in both SW 5th Street to the south and Kinsman Road to the west.

Because no public utilities are located within the right-of-way requested for vacation, no public utility easement is required within the area of the proposed right-of-way vacation.

(.06) Nothing in this Code shall prevent the owner of a site that is less than two (2) acres in size from filing an application to rezone and develop the site as a Planned Development. Smaller properties may or may not be suitable for such development, depending upon their particular sizes, shapes, locations, and the nature of the proposed development, but Planned Developments shall be encouraged at any appropriate location.

Response: The subject property is larger than two (2) acres. This standard does not apply.

(.07) Density Transfers. In order to protect significant open space or resource areas, the Development Review Board may authorize the transfer of development densities from one portion of a proposed development to another. Such transfers may go to adjoining properties, provided that those properties are considered to be part of the total development under consideration as a unit.

Response: The applicant is not proposing a density transfer. This standard does not apply.

(.08) Wetland Mitigation and other mitigation for lost or damaged resources. The Development Review Board may, after considering the testimony of experts in the field, allow for the replacement of resource areas with newly created or enhanced resource areas. The Board may specify the ratio of lost to created and/or enhanced areas after making findings based on information in the record. As much as possible, mitigation areas shall replicate the beneficial values of the lost or damaged resource areas.

Response: The western boundary of the subject property contains a significant creek resource (Coffee Lake Creek) and is partially within the Significant Resource Overlay Zone (SROZ). This standard is not applicable.

(.09) Habitat-Friendly Development Practices. To the extent practicable, development and construction activities of any lot shall consider the use of habitat-friendly development practices, which include:

- A. *Minimizing grading, removal of native vegetation, disturbance and removal of native soils, and impervious area;*
- B. *Minimizing adverse hydrological impacts on water resources, such as using the practices described in Part (a) of Table NR-2 in Section 4.139.03, unless their use is prohibited by an applicable and required state or federal permit, such as a permit required under the federal Clean Water Act, 33 U.S.C. §§1251 et seq., or the federal Safe Drinking Water Act, 42 U.S.C. §§300f et seq., and including conditions or plans required by such permit;*
- C. *Minimizing impacts on wildlife corridors and fish passage, such as by using the practices described in Part (b) of Table NR-2 in Section 4.139.03; and*
- D. *Using the practices described in Part (c) of Table NR-2 in Section 4.139.03.*

Response: The western boundary of the subject property contains a significant creek resource (Coffee Lake Creek) and is partially within the Significant Resource Overlay Zone (SROZ). No impact is proposed within the SROZ or SROZ impact area. A vegetated stormwater facility is proposed within the SROZ Impact Area as shown on Sheet C2 of Exhibit E. This standard is met.

Section 4.120. - Zones. FDA-H Future Development Agricultural—Holding Zone.

Responses to Section 4.120 are provided to demonstrate compliance of adjusted tax lot 600 to the standards of Section 4.120.

(.05) Dimensional Standards

- A. *Minimum Lot Size: 30,000 square feet.*

Response: As shown on Sheet C1 of Exhibit E, tax lot 600 measures approximately 301,000 SF, greater than the required minimum lot size of 30,000 SF. This standard is met.

B. Minimum Front and Rear Yard Setbacks: 30 feet.

Minimum Side Yard Setback: Ten feet.

1. *Minimum setback for residential garage or carport: At least five feet behind the front of the nearest residential unit on the property. In no case shall the front of a garage or carport be located less than twenty (20) feet behind a sidewalk or a public right-of-way providing access to that garage or carport. Except, however, in the case of an alley where garages or carports are located within five feet of the property line adjoining the alley.*

Response: No structures are proposed or are located on tax lot 600. This standard is not applicable.

C. Minimum Street Frontage: 75 feet. A reduced street frontage may be approved, based on a finding that the proposed lot frontage will not hinder the future development of the site to densities proposed in the Comprehensive Plan.

Response: Tax lot 600 has over 75' of frontage on SW 5th Street, as shown on Sheet C1 of Exhibit. This standard is met.

D. Maximum Height: 35 feet.

Response: No structures are proposed or are located on tax lot 600. This standard is not applicable.

E. Accessory buildings and uses shall conform to front and side yard setback requirements. If the accessory buildings and uses do not exceed 120 square feet or ten feet in height, and they are detached and located behind the rear-most line of the main buildings, the side and rear yard setbacks may be reduced to three feet.

Response: No accessory buildings or uses are proposed or are located on tax lot 600. This standard is not applicable.

Section 4.135. - PDI—Planned Development Industrial Zone.

(.01) Purpose. The purpose of the PDI zone is to provide opportunities for a variety of industrial operations and associated uses.

Response: Subsequent to the requested zone change, the entirety of the area requested for zone change will be located in the Planned Development Industrial (PDI) Zone. This proposal seeks approval for a parking area to serve an existing industrial use, new driveway accessing SW 5th Street, and associated landscaping, stormwater facilities, and lighting. The proposed improvements will provide support for the existing industrial use.

(.02) The PDI Zone shall be governed by Section 4.140, Planned Development Regulations, and as otherwise set forth in this Code.

Response: The applicant has provided responses to Section 4.140 within this narrative. This standard is satisfied.

(.03) Uses that are typically permitted:

- A. *Warehouses and other buildings for storage of wholesale goods, including cold storage plants.*
- B. *Storage and wholesale distribution of agricultural and other bulk products, provided that dust and odors are effectively contained within the site.*
- C. *Assembly and packing of products for wholesale shipment.*
- D. *Manufacturing and processing.*

- E. *Motor vehicle services, or other services complementary or incidental to primary uses, and which support the primary uses by allowing more efficient or cost-effective operations.*
- F. *Manufacturing and processing of electronics, technical instrumentation components and health care equipment.*
- G. *Fabrication.*
- H. *Office complexes—Technology.*
- I. *Corporate headquarters.*
- J. *Call centers.*
- K. *Research and development.*
- L. *Laboratories.*
- M. *Repair, finishing and testing of product types manufactured or fabricated within the zone.*
- N. *Industrial services.*
- O. *Any use allowed in a PDC Zone, subject to the following limitations:*
 - 1. *Service Commercial uses (defined as professional services that cater to daily customers such as financial, insurance, real estate, legal, medical or dental offices) not to exceed 5,000 square feet of floor area in a single building, or 20,000 square feet of combined floor area within a multi-building development.*
 - 2. *Office Complex Use (as defined in Section 4.001) shall not exceed 30 percent of total floor area within a project site.*
 - 3. *Retail uses, not to exceed 5,000 square feet of indoor and outdoor sales, service or inventory storage area for a single building and 20,000 square feet of indoor and outdoor sales, service or inventory storage area for multiple buildings.*
 - 4. *Combined uses under Subsections 4.135(.03)(O.)(1.) and (3.) shall not exceed a total of 5,000 square feet of floor area in a single building or 20,000 square feet of combined floor area within a multi-building development.*
- P. *Training facilities whose primary purpose is to provide training to meet industrial needs.*
- Q. *Public facilities.*
- R. *Accessory uses, buildings and structures customarily incidental to any permitted uses.*
- S. *Temporary buildings or structures for uses incidental to construction work. Such structures to be removed within 30 days of completion or abandonment of the construction work.*
- T. *Other similar uses, which in the judgment of the Planning Director, are consistent with the purpose of the PDI Zone.*

Response: This proposal seeks approval for a parking area to serve an existing manufacturing use, new driveway accessing SW 5th Street, and associated landscaping, stormwater facilities, and lighting. The applicant's intent is to enable the site to accommodate future development for any of the uses allowed by 4.135(.03) A through T. This standard is met.

(.04) Block and access standards. The PDI zone shall be subject to the same block and access standards as the PDC zone, Section 4.131(.02) and (.03).

Response: No residential or mixed-use development is proposed as part of this application (in reference to Section 4.131(.03)). This proposal does not modify the existing block and access standards. This standard is met.

(.05) Performance Standards. The following performance standards apply to all industrial properties and sites within the PDI Zone, and are intended to minimize the potential adverse impacts of industrial activities on the general public and on other land uses or activities. They are not intended to prevent conflicts between different uses or activities that may occur on the same property.

- A. *All uses and operations except storage, off-street parking, loading and unloading shall be confined, contained, and conducted wholly within completely enclosed buildings, unless*

outdoor activities have been approved as part of Stage II, Site Design or Administrative Review.

- B. *Vibration. Every use shall be so operated that the ground vibration inherently and recurrently generated from equipment other than vehicles is not perceptible without instruments at any boundary line of the property on which the use is located.*
- C. *Emission of odorous gases or other odorous matter in quantities as detectable at any point on any boundary line of the property on which the use is located shall be prohibited.*
- D. *Any open storage shall comply with the provisions of Section 4.176, and this Section.*
- E. *No building customarily used for night operation, such as a baker or bottling and distribution station, shall have any opening, other than stationary windows or required fire exits, within 100 feet of any residential district and any space used for loading or unloading commercial vehicles in connection with such an operation shall not be within 100 feet of any residential district.*
- F. *Heat and Glare:*
 - 1. *Operations producing heat or glare shall be conducted entirely within an enclosed building.*
 - 2. *Exterior lighting on private property shall be screened, baffled, or directed away from adjacent residential properties. This is not intended to apply to street lighting.*
- G. *Dangerous Substances. Any use which involves the presence, storage or handling of any explosive, nuclear waste product, or any other substance in a manner which would cause a health or safety hazard for any adjacent land use or site shall be prohibited.*
- H. *Liquid and Solid Wastes:*
 - 1. *Any storage of wastes which would attract insects or rodents or otherwise create a health hazard shall be prohibited.*
 - 2. *Waste products which are stored outside shall be concealed from view from any property line by a sight-obscuring fence or planting as required in Section 4.176.*
 - 3. *No connection with any public sewer shall be made or maintained in violation of applicable City or State standards.*
 - 4. *No wastes conveyed shall be allowed to or permitted, caused to enter, or allowed to flow into any public sewer in violation of applicable City or State standards.*
 - 5. *All drainage permitted to discharge into a street gutter, caused to enter or allowed to flow into any pond, lake, stream, or other natural water course shall be limited to surface waters or waters having similar characteristics as determined by the City, County, and State Department of Environmental Quality.*
 - 6. *All operations shall be conducted in conformance with the City's standards and ordinances applying to sanitary and storm sewer discharges.*
- I. *Noise. Noise generated by the use, with the exception of traffic noises from automobiles, trucks, and trains, shall not violate any applicable standards adopted by the Oregon Department of Environmental Quality and W.C. 6.204 governing noise control in the same or similar locations.*
- J. *Electrical Disturbances. Except for electrical facilities wherein the City is preempted by other governmental entities, electrical disturbances generated by uses within the PDI zone which interfere with the normal operation of equipment or instruments within the PDI Zone are prohibited. Electrical disturbances which routinely cause interference with normal activity in abutting residential use areas are also prohibited.*
- K. *Discharge Standards. There shall be no emission of smoke, fallout, fly ash, dust, vapor, gases, or other forms of air pollution that may cause a nuisance or injury to human, plant, or animal life, or to property. Plans of construction and operation shall be subject to the recommendations and regulations of the State Department of Environmental Quality. All measurements of air pollution shall be by the procedures and with equipment approved*

by the State Department of Environmental Quality or equivalent and acceptable methods of measurement approved by the City. Persons responsible for a suspected source of air pollution upon the request of the City shall provide quantitative and qualitative information regarding the discharge that will adequately and accurately describe operation conditions.

L. Open burning is prohibited.

M. Storage:

1. Outdoor storage must be maintained in an orderly manner at all times.
2. Outdoor storage area shall be gravel surface or better and shall be suitable for the materials being handled and stored. If a gravel surface is not sufficient to meet the performance standards for the use, the area shall be suitably paved.
3. Any open storage that would otherwise be visible at the property line shall be concealed from view at the abutting property line by a sight obscuring fence or planting not less than six feet in height.

N. Landscaping:

1. Unused property, or property designated for expansion or other future use, shall be landscaped and maintained as approved by the Development Review Board. Landscaping for unused property disturbed during construction shall include such things as plantings of ornamental shrubs, lawns, native plants, and mowed, seeded fieldgrass.
2. Contiguous unused areas of undisturbed fieldgrass may be maintained in their existing state. Large stands of invasive weeds such as Himalayan blackberries, English ivy, cherry Laurel, reed canary grass or other identified invasive plants shall be removed and/or mowed at least annually to reduce fire hazard. These unused areas, located within a phased development project or a future expansion cannot be included in the area calculated to meet the landscape requirements for the initial phase(s) of the development.
3. Unused property shall not be left with disturbed soils that are subject to siltation and erosion. Any disturbed soil shall be seeded for complete erosion cover germination and shall be subject to applicable erosion control standards.

Response: This proposal seeks approval for a parking area and driveway to serve an existing manufacturing (Industrial) use, along with associated landscaping, stormwater facilities, and lighting. The site operations are similar and compatible to that of similar, adjacent industrial uses. This standard is met.

(.06) Other Standards:

A. *Minimum Individual Lot Size. No limit save and except as shall be consistent with the other provisions of this Code (e.g., landscaping, parking, etc.).*

Response: After the requested lot line adjustment, the following lots of the Subject Site will be:

Tax lot 101: 307,175 SF

Tax lot 200: 41,817 SF (no change from existing)

Tax lot 300: 26,136 SF (no change from existing)

Tax lot 600: 301,384 SF (to remain zoned FDAHI, not subject the Planned Development Stage I, Stage II, Site Development Review, or Zone Map Amendment applications).

B. *Maximum Lot Coverage. No limit save and except as shall be consistent with the other provisions of this Code (e.g., landscaping, parking, etc.).*

Response: No new structures are proposed. Compliance with other applicable provisions of the Wilsonville Code is described in their respective Section(s). This standard is met.

C. *Front Yard Setback. Thirty (30) feet. Structures on corner or through lots shall observe the minimum front yard setback on both streets. Setbacks shall also be maintained from the planned rights-of-way shown on any adopted City street plan.*

Response: No buildings are proposed as part of this development. This standard is not applicable.

D. *Rear and Side Yard Setback. Thirty (30) feet. Structures on corner or through lots shall observe the minimum rear and side yard setbacks on both streets. Setbacks shall also be maintained from the planned rights-of-way shown on any adopted City street plan.*

Response: No buildings are proposed as part of this development. This standard is not applicable.

E. *No setback is required when side or rear yards abut on a railroad siding.*

Response: No buildings are proposed as part of this development. This standard is not applicable.

F. *Corner Vision: Corner lots shall have no sight obstruction to exceed the vision clearance standards of Section 4.177.*

G. *Off-Street Parking and Loading: As provided in Section 4.155.*

H. *Signs: As provided in Sections 4.156.01 through 4.156.11.*

Response: As shown on Sheets C3 of Exhibit E, vision clearance standards are satisfied. Compliance with the standards of Section 4.155 is described in the Applicant’s response to Section 4.155, herein. No new signage is proposed. This standard is met.

Section 4.140. Planned Development Regulations

(.02) *Lot Qualification.*

A. *Planned Development may be established on lots which are suitable for and of a size to be planned and developed in a manner consistent with the purposes and objectives of Section 4.140.*

B. *Any site designated for development in the Comprehensive Plan may be developed as a Planned Development, provided that it is zoned “PD.” All sites which are greater than two (2) acres in size, and designated in the Comprehensive Plan for commercial, residential, or industrial use shall be developed as Planned Developments, unless approved for other uses permitted by the Development Code. Smaller sites may also be developed through the City’s PD procedures, provided that the location, size, lot configuration, topography, open space and natural vegetation of the site warrant such development.*

Response: The site exceeds two (2) acres and is designated Industrial in the Comprehensive Plan; it is therefore designated for planned development. This standard applies.

(.03) *Ownership.*

A. *The tract or tracts of land included in a proposed Planned Development must be in one (1) ownership or control or the subject of a joint application by the owners of all the property included. The holder of a written option to purchase, with written authorization by the owner to make applications, shall be deemed the owner of such land for the purposes of Section 4.140.*

B. *Unless otherwise provided as a condition for approval of a Planned Development permit, the permittee may divide and transfer units or parcels of any development. The transferee shall use and maintain each such unit or parcel in strict conformance with the approval permit and development plan.*

Response: The Owner has signed the application form included as Exhibit A. This standard is met.

(.04) *Professional Design.*

- A. *The applicant for all proposed Planned Developments shall certify that the professional services of the appropriate professionals have been utilized in the planning process for development.*
- B. *Appropriate professionals shall include, but not be limited to the following to provide the elements of the planning process set out in Section 4.139:*
 - 1. *An architect licensed by the State of Oregon;*
 - 2. *A landscape architect registered by the State of Oregon;*
 - 3. *An urban planner holding full membership in the American Institute of Certified Planners, or a professional planner with prior experience representing clients before the Development Review Board, Planning Commission, or City Council; or*
 - 4. *A registered engineer or a land surveyor licensed by the State of Oregon.*
- C. *One of the professional consultants chosen by the applicant from either 1, 2, or 3, above, shall be designated to be responsible for conferring with the planning staff with respect to the concept and details of the plan.*
- D. *The selection of the professional coordinator of the design team will not limit the owner or the developer in consulting with the planning staff.*

Response: The applicant certifies that appropriate professionals have been utilized including Oregon-licensed/registered landscape architect, an AICP planner, and professional engineer. More particularly, the design team leadership includes the following:

- Landscape Architect: Andrew Jepson-Sullivan; Nicole Ferriera, PLA
- Planner: Sid Hariharan Godt; Lee Leighton, AICP
- Civil Engineer: Tom Sisul, PE

This standard is met.

(.05) Planned Development Permit Process.

- A. *All parcels of land exceeding two (2) acres in size that are to be used for residential, commercial or industrial development, shall, prior to the issuance of any building permit:*
 - 1. *Be zoned for planned development;*
 - 2. *Obtain a planned development permit; and*
 - 3. *Obtain Development Review Board, or, on appeal, City Council approval.*
- B. *Zone change and amendment to the zoning map are governed by the applicable provisions of the Zoning Sections, inclusive of Section 4.197*
- C. *Development Review Board approval is governed by Sections 4.400 to 4.450*
- D. *All planned developments require a planned development permit. The planned development permit review and approval process consists of the following multiple stages, the last two or three of which can be combined at the request of the applicant:*
 - 1. *Pre-application conference with Planning Department;*
 - 2. *Preliminary (Stage I) review by the Development Review Board. When a zone change is necessary, application for such change shall be made simultaneously with an application for preliminary approval to the Board; and*
 - 3. *Final (Stage II) review by the Development Review Board*
 - 4. *In the case of a zone change and zone boundary amendment, City Council approval is required to authorize a Stage I preliminary plan.*

Response: The site meets the criteria for a planned development, and with this application, the applicant is simultaneously requesting approval of the following applications:

- Zone Map Amendment
- Stage I and II Planned Development Review

- Site Design Review
- Street Vacation
- Lot Line Adjustment
- Type C Tree Removal Permit

These provisions allow applicants to combine approval requests in this manner. These provisions are satisfied.

(.06) Staff Report:

- A. *The planning staff shall prepare a report of its findings and conclusions as to whether the use contemplated is consistent with the land use designated on the Comprehensive Plan. If there is a disagreement as to whether the use contemplated is consistent, the applicant, by request, or the staff, may take the preliminary information provided to the Development Review Board for a use interpretation.*
- B. *The applicant may proceed to apply for Stage I - Preliminary Approval - upon determination by either staff or the Development Review Board that the use contemplated is consistent with the Comprehensive Plan.*

Response: The applicant is requesting both Planned Development Stage I and Stage II approvals as part of this application, and requests prompt review of the complete application package.

(.07) Preliminary Approval (Stage One):

- A. *Applications for preliminary approval for planned developments shall:*
 1. *Be made by the owner of all affected property or the owner's authorized agent; and*
 2. *Be filed on a form prescribed by the City Planning Department and filed with said Department.*
 3. *Set forth the professional coordinator and professional design team as provided in subsection (.04), above.*
 4. *State whether the development will include mixed land uses, and if so, what uses and in what proportions and locations.*

Response: This application package includes the required information to meet these evidence requirements.

- B. *The application shall include conceptual and quantitatively accurate representations of the entire development sufficient to judge the scope, size, and impact of the development on the community; and, in addition to the requirements set forth in Section 4.035, shall be accompanied by the following information:*
 1. *A boundary survey or a certified boundary description by a registered engineer or licensed surveyor.*

Response: A survey is included as Exhibit D. This standard is met.

2. *Topographic information as set forth in Section 4.035*

Response: Topographic information as set forth in Section 4.035 shown on Sheet C3 of Exhibit E. This standard is met.

3. *A tabulation of the land area to be devoted to various uses, and a calculation of the average residential density per net acre.*

Response: The entire use of the site is industrial. A tabulation of land area is shown on the sheets provided in Exhibit E. This standard is met.

4. *A stage development schedule demonstrating that the developer intends receive Stage II approval within two (2) years of receiving Stage I approval, and to commence construction within two (2) years after the approval of the final development plan, and will proceed diligently to completion; unless a phased development schedule has been approved; in which case adherence to that schedule shall be considered to constitute diligent pursuit of project completion.*

Response: The applicant has submitted for concurrent approval of Planned Development Stage I and Stage II requests, together with Site Design Review and related requests, to allow full development of the project in a single phase, to commence within two (2) years following approvals.

5. *A commitment by the applicant to provide in the Final Approval (Stage II) a performance bond or other acceptable security for the capital improvements required by the project.*

Response: No capital improvements are required by this project. This standard is not applicable.

6. *If it is proposed that the final development plan will be executed in stages, a schedule thereof shall be provided.*

Response: This provision is not applicable because a single phase of construction is proposed.

7. *Statement of anticipated waivers from any of the applicable site development standards.*

Response: No waivers are requested as part of this proposal.

C. *An application for a Stage I approval shall be considered by the Development Review Board as follows:*

1. *A public hearing as provided in Section 4.013.*
2. *After such hearing, the Board shall determine whether the proposal conforms to the permit criteria set forth in this Code, and may approve or disapprove the application and the accompanying preliminary development plan or require such changes therein or impose such conditions of approval as are in its judgment, necessary to ensure conformity to said criteria and regulations. In so doing, the Board may, in its discretion, authorize submission of the final development plan in stages, corresponding to different units or elements of the development. It shall do so only upon evidence assuring completion of the entire development in accordance with the preliminary development plan and stage development schedule.*
3. *A final decision on a complete application and preliminary plan shall be rendered within one hundred and twenty (120) days after the application is deemed complete unless a continuance is agreed upon by the applicant and the appropriate City decision-making body.*
4. *The determination of the Development Review Board shall become final at the end of the appeal period for the decision, unless appealed to the City Council in accordance with Section 4.022 of this Code.*

Response: This provision provides procedural guidance for implementation and requires no evidence within the applicant's narrative.

(.09) *Final Approval (Stage Two):*

[Note: Outline Number is incorrect.]

- A. *Unless an extension has been granted by the Development Review Board, within two (2) years after the approval or modified approval of a preliminary development plan (Stage I), the applicant shall file with the City Planning Department a final plan for the entire development or when submission in stages has been authorized pursuant to Section 4.035 for the first unit of the development, a public hearing shall be held on each such application as provided in Section 4.013.*
- B. *After such hearing, the Development Review Board shall determine whether the proposal conforms to the permit criteria set forth in this Code, and shall approve, conditionally approve, or disapprove the application.*
- C. *The final plan shall conform in all major respects with the approved preliminary development plan, and shall include all information included in the preliminary plan plus the following:*
 - 1. *The location of water, sewerage and drainage facilities;*
 - 2. *Preliminary building and landscaping plans and elevations, sufficient to indicate the general character of the development;*
 - 3. *The general type and location of signs;*
 - 4. *Topographic information as set forth in Section 4.035;*
 - 5. *A map indicating the types and locations of all proposed uses; and*
 - 6. *A grading plan.*
- D. *The final plan shall be sufficiently detailed to indicate fully the ultimate operation and appearance of the development or phase of development. However, Site Design Review is a separate and more detailed review of proposed design features, subject to the standards of Section 4.400.*

Response: The applicant is requesting approval of both Planned Development Stage I and Stage II approvals, together with Site Design Review and other land use requests, as part of this consolidated application. Accordingly, the final plan provides sufficient information regarding conformance with both the preliminary development plan and Site Design Review. This standard is met.

- E. *Copies of legal documents required by the Development Review Board for dedication or reservation of public facilities, or for the creation of a non-profit homeowner's association, shall also be submitted.*

Response: Planned Development Stage I and Stage II approvals, together with Site Design Review and other land use requests, are requested as part of this consolidated application; the Development Review Board has not yet required dedication or reservation of public facilities. There is no reason to form a homeowner's association or other entity to support this development. This standard does not apply.

- F. *Within thirty (30) days after the filing of the final development plan, the Planning staff shall forward such development plan and the original application to the Tualatin Valley Fire and Rescue District, if applicable, and other agencies involved for review of public improvements, including streets, sewers and drainage. The Development Review Board shall not act on a final development plan until it has first received a report from the agencies or until more than thirty (30) days have elapsed since the plan and application were sent to the agencies, whichever is the shorter period.*

Response: This provision provides procedural guidance for implementation and requires no evidence from the applicant.

- G. *Upon receipt of the final development plan, the Development Review Board shall conduct a public hearing and examine such plan and determine:*
1. *Whether it conforms to all applicable criteria and standards; and*
 2. *Whether it conforms in all substantial respects to the preliminary approval; or*
 3. *Require such changes in the proposed development or impose such conditions of approval as are in its judgment necessary to insure conformity to the applicable criteria and standards.*
- H. *If the Development Review Board permits the applicant to revise the plan, it shall be resubmitted as a final development plan within sixty (60) days. If the Board approves, disapproves or grants such permission to resubmit, the decision of the Board shall become final at the end of the appeal period for the decision, unless appealed to the City Council, in accordance with Sections 4.022 of this Code.*

Response: As the applicant is requesting both Planned Development Stage I and Stage II approvals as part of this application, the final development plan is integrally consistent with the preliminary development plan; therefore, the applicant does not need to revise the final plan to comply with a prior Stage I approval. The applicant's narrative and accompanying plans and reports demonstrate conformance with applicable approval standards for the Planned Development and Site Design Review. This standard is met.

- I. *All Stage II Site Development plan approvals shall expire two years after their approval date, if substantial development has not occurred on the property prior to that time. Provided, however, that the Development Review Board may extend these expiration times for up to three (3) additional periods of not more than one (1) year each. Applicants seeking time extensions shall make their requests in writing at least thirty (30) days in advance of the expiration date. Requests for time extensions shall only be granted upon (1) a showing that the applicant has in good faith attempted to develop or market the property in the preceding year or that development can be expected to occur within the next year, and (2) payment of any and all Supplemental Street SDCs applicable to the development. Upon such payment, the development shall have vested traffic generation rights under 4.140 (.10), provided however, that if the Stage II approval should expire, the vested right to use trips is terminated upon City repayment, without interest, of Supplemental Street SDCs. For purposes of this Ordinance, "substantial development" is deemed to have occurred if the required building permits or public works permits have been issued for the development, and the development has been diligently pursued, including the completion of all conditions of approval established for the permit. [Amended by Ord 561, adopted 12/15/03.]*

Response: The applicant intends to construct the proposed improvements in one (1) implementation phase promptly after land use approval, and within the allotted time period. To that end, the applicant is requesting both Planned Development Stage I and Stage II approvals, together with Site Design Review and other land use requests, as part of this consolidated application. This standard is met.

- J. *A planned development permit may be granted by the Development Review Board only if it is found that the development conforms to all the following criteria, as well as to the Planned Development Regulations in Section 4.140:*
1. *The location, design, size and uses, both separately and as a whole, are consistent with the Comprehensive Plan, and with any other applicable plan, development map or Ordinance adopted by the City Council.*

Response: The proposed parking lot and site improvements, to support the existing industrial use, are consistent with the intent of the PDI Zone and Industrial Comprehensive Plan designation.

2. *That the location, design, size and uses are such that traffic generated by the development at the most probable used intersection(s) can be accommodated safely and without congestion in excess of Level of Service D, as defined in the Highway Capacity Manual published by the National Highway Research Board, on existing or immediately planned arterial or collector streets and will, in the case of commercial or industrial developments, avoid traversing local streets. Immediately planned arterial and collector streets are those listed in the City's adopted Capital Improvement Program, for which funding has been approved or committed, and that are scheduled for completion within two years of occupancy of the development or four year if they are an associated crossing, interchange, or approach street improvement to Interstate 5.*
 - a. *In determining levels of Service D, the City shall hire a traffic engineer at the applicant's expense who shall prepare a written report containing the following minimum information for consideration by the Development Review Board:*
 - i. *An estimate of the amount of traffic generated by the proposed development, the likely routes of travel of the estimated generated traffic, and the source(s) of information of the estimate of the traffic generated and the likely routes of travel; [Added by Ord. 561, adopted 12/15/03.]*
 - ii. *What impact the estimate generated traffic will have on existing level of service including traffic generated by (1) the development itself, (2) all existing developments, (3) Stage II developments approved but not yet built, and (4) all developments that have vested traffic generation rights under section 4.140(.10), through the most probable used intersection(s), including state and county intersections, at the time of peak level of traffic. This analysis shall be conducted for each direction of travel if backup from other intersections will interfere with intersection operations. [Amended by Ord 561, adopted 12/15/03.]*
 - b. *The following are exempt from meeting the Level of Service D criteria standard:*
 - i. *A planned development or expansion thereof which generates three (3) new p.m. peak hour traffic trips or less;*
 - ii. *A planned development or expansion thereof which provides an essential governmental service.*
 - c. *Traffic generated by development exempted under this subsection on or after Ordinance No. 463 was enacted shall not be counted in determining levels of service for any future applicant. [Added by Ord 561, adopted 12/15/03.]*
 - d. *Exemptions under 'b' of this subsection shall not exempt the development or expansion from payment of system development charges or other applicable regulations. [Added by Ord 561, adopted 12/15/03.]*
 - e. *In no case will development be permitted that creates an aggregate level of traffic at LOS "F". ([Added by Ord 561, adopted 12/15/03.]*

Response: No new building area is proposed as part of this proposed development. The proposed parking lot and new access are to support the existing industrial use. Per the City's pre-application conference notes (Exhibit I), a Traffic Impact Study is not required as a parking lot expansion does not generate new vehicle trips. This standard is not applicable.

3. *That the location, design, size and uses are such that the residents or establishments to be accommodated will be adequately served by existing or immediately planned facilities and services.*

Response: The improvements to SW 5th Street, including the necessary water, sewer, and stormwater facilities, have considered the future development pattern of the area. The public facilities have been sized accordingly. No new public facilities or frontage improvements are warranted or proposed as part of this development. This standard is met.

- K. *Mapping: Whenever a Planned Development permit has been granted, and so long as the permit is in effect, the boundary of the Planned Development shall be indicated on the Zoning Map of the City of Wilsonville as the appropriate "PD" Zone.*

Response: This provision provides procedural guidance to staff for implementation and requires no evidence from the applicant.

- L. *Adherence to Approved Plan and Modification Thereof: The applicant shall agree in writing to be bound, for her/himself and her/his successors in interest, by the conditions prescribed for approval of a development. The approved final plan and stage development schedule shall control the issuance of all building permits and shall restrict the nature, location and design of all uses. Minor changes in an approved preliminary or final development plan may be approved by the Director of Planning if such changes are consistent with the purposes and general character of the development plan. All other modifications, including extension or revision of the stage development schedule, shall be processed in the same manner as the original application and shall be subject to the same procedural requirements.*

Response: The applicant fully intends to comply with the City's approval and intends to sign the necessary agreements. This standard is met.

- M. *In the event of a failure to comply with the approved plan or any prescribed condition of approval, including failure to comply with the stage development schedule, the Development Review Board may, after notice and hearing, revoke a Planned Development permit. General economic conditions that affect all in a similar manner may be considered as a basis for an extension of a development schedule. The determination of the Board shall become final thirty (30) days after the date of decision unless appealed to the City Council.*

Response: This provision provides procedural guidance for implementation and requires no evidence from the applicant. The applicant fully intends to comply with the City's approval.

(.10) *Early Vesting of Traffic Generation. Applicants with Stage I or Master Plan approvals occurring after June 2, 2003 may apply to vest the right to use available transportation capacity at the intersections of Wilsonville Road with Boone's Ferry Road and with Town Center Loop West, and/or the I-5 interchange. Vesting for properties with such approvals shall occur upon execution of a vesting agreement satisfactory to the city, which agreement shall include a proposed development schedule or phasing plan and either provide for the payment of any and all Supplemental Street SDCs or provide other means of financing*

public improvements. Vesting for properties pending such approvals shall occur upon such agreement and the date the approvals are final.

The number of trips vested is subject to modification based upon updated traffic analysis associated with subsequent development approvals for the property. A reduction in vested trips shall attend repayment of vesting fees by the City. An increase in available vested trips shall occur upon payment of necessary vesting fees.

Vesting shall remain valid and run with the property, unless an approval that is necessary for vesting to occur is terminated or a vesting agreement is terminated. If the vested right to use certain trips is lost or terminated, as determined by the Community Development Director with the concurrence of City Council, such trips shall be made available to other development upon City repayment, without interest, of associated vesting fees.

Response: The applicant is not proposing to vest trips or utilize vested trips. This standard does not apply.

Section 4.139.00. - Significant Resource Overlay Zone (SROZ) Ordinance.

Section 4.139.02. - Where these Regulations Apply.

The regulations of this Section apply to the portion of any lot or development site, which is within a Significant Resource Overlay Zone and its associated "Impact Areas". The text provisions of the Significant Resource Overlay Zone ordinance take precedence over the Significant Resource Overlay Zone maps. The Significant Resource Overlay Zone is described by boundary lines shown on the City of Wilsonville Significant Resource Overlay Zone Map. For the purpose of implementing the provisions of this Section, the Wilsonville Significant Resource Overlay Zone Map is used to determine whether a Significant Resource Impact Report (SRIR) is required. Through the development of an SRIR, a more specific determination can be made of possible impacts on the significant resources.

Unless otherwise exempted by these regulations, any development proposed to be located within the Significant Resource Overlay Zone and/or Impact Area must comply with these regulations. Where the provisions of this Section conflict with other provisions of the City of Wilsonville Planning and Land Development Ordinance, the more restrictive shall apply.

The SROZ represents the area within the outer boundary of all inventoried significant natural resources. The Significant Resource Overlay Zone includes all land identified and protected under Metro's UGMFP Title 3 Water Quality Resource Areas and Title 13 Habitat Conservation Areas, as currently configured, significant wetlands, riparian corridors, and significant wildlife habitat that is inventoried and mapped on the Wilsonville Significant Resource Overlay Zone Map.

Response: As shown in Exhibit E, a portion of the site, along the western property boundary, is located within the SROZ. This Section is applicable as described in the Applicant's responses to Section 4.139.

Section 4.139.03. - Administration.

(.01) Resources. The text provisions of this section shall be used to determine whether applications may be approved within the Significant Resource Overlay Zone. The following maps and documents may be used as references for identifying areas subject to the requirements of this Section:

- A. Metro's UGMFP Title 3 Water Quality Resource Area maps.
- B. The Federal Emergency Management Agency (FEMA) Flood Insurance Rate Maps (FIRM).
- C. The Wilsonville Local Wetland Inventory (LWI) (1998).
- D. The Wilsonville Riparian Corridor Inventory (RCI) (1998).
- E. Locally adopted studies or maps.

- F. City of Wilsonville slope analysis maps.
- G. Clackamas and Washington County soils surveys.
- H. Metro's UGMFP Title 13 Habitat Conservation Area Map.

(.02) Impact Area. The "Impact Area" is the area adjacent to the outer boundary of a Significant Resource within which development or other alteration activities may be permitted through the review of an SRIR (Significant Resource Impact Report). Where it can be clearly determined by the Planning Director that development is only in the Impact Area and there is no impact to the Significant Resource, development may be permitted without SRIR review. The impact area is 25 feet wide unless otherwise specified in this ordinance or by the decision making body. Designation of an Impact Area is required by Statewide Planning Goal 5. The primary purpose of the Impact Area is to ensure that development does not encroach into the SROZ.

Response: As shown in Exhibit E, no impact is proposed within the SROZ. The grading with the associated vegetated stormwater facility will occur within the SROZ Impact Area.

(.03) Significant Resource Impact Report (SRIR). For proposed non-exempt development within the SROZ, the applicant shall submit a Significant Resource Impact Report (SRIR) as part of any application for a development permit.

Response: No impacts are proposed within the SROZ. This standard is not applicable.

(.04) Prohibited Activities. New structures, development and construction activities shall not be permitted within the SROZ if they will negatively impact significant natural resources. Gardens, lawns, application of chemicals, uncontained areas of hazardous materials as defined by DEQ, domestic animal waste, dumping of materials of any kind, or other activities shall not be permitted within the SROZ if they will negatively impact water quality.

Response: No impacts are proposed within the SROZ. This standard is not applicable. This standard is not applicable.

Unauthorized land clearing or grading of a site to alter site conditions is not allowed, and may result in the maximum requirement of mitigation/enhancement regardless of pre-existing conditions.

Response: As shown on Sheet C1.10 of Exhibit E, no new structures, development, or construction activities are proposed within the SROZ. No work that would negatively impact water quality is proposed. This standard is met.

(.05) Habitat-Friendly Development Practices. To the extent practicable, development and construction activities that encroach within the Significant Resource Overlay Zone and/or Impact Area shall be designed, located and constructed to:

- A. Minimize grading, removal of native vegetation, disturbance and removal of native soils, and impervious area;
- B. Minimize adverse hydrological impacts on water resources, such as using the practices described in Part (a) of Table NR-2, unless their use is prohibited by an applicable and required state or federal permit, such as a permit required under the federal Clean Water Act, 33 U.S.C. §§ 1251 et seq., or the federal Safe Drinking Water Act, 42 U.S.C. §§ 300f et seq., and including conditions or plans required by such permit;
- C. Minimize impacts on wildlife corridors and fish passage, such as by using the practices described in Part (b) of Table NR-2; and
- D. Consider using the practices described in Part (C) of Table NR-2.

Response: As shown in Exhibit E, the proposed development incorporates the following Habitat-Friendly Development Practices from Table NR-2: *Habitat-Friendly Development Practices:*

- A.4. Landscape with rain gardens to provide on-lot detention, filtering of rainwater and groundwater re-charge.
- A.8. Use multi-functional open drainage systems in lieu of more conventional curb and gutter systems.
- C.2. Locate landscaping adjacent to SROZ.
- C.4. Preserve and maintain existing trees and tree canopy coverage, and plant trees, where appropriate, to maximize future tree canopy coverage.

This standard is met.

Section 4.139.04. - Uses and Activities Exempt from These Regulations

A request for exemption shall be consistent with the submittal requirements listed under Section 4.139.06 (.01)(B–I), as applicable to the exempt use and activity.

- (.01) Emergency procedures or emergency activities undertaken which are necessary for the protection of public health, safety, and welfare. Measures to remove or abate hazards and nuisances. Areas within the SROZ that are disturbed because of emergency procedures or activities should be repaired and mitigated.
- (.02) Maintenance and repair of buildings, structures, yards, gardens or other activities or uses that were in existence prior to the effective date of these regulations.
- (.03) Alterations of buildings or accessory structures which do not increase building coverage.
- (.04) The following agricultural activities lawfully in existence as of the effective date of this ordinance:
 - A. Mowing of hay, grass or grain crops.
 - B. Tilling, disking, planting, seeding, harvesting and related activities for pasture, tree crops, commercial woodlots, food crops or business crops, provided that no additional lands within the SROZ are converted to these uses after the effective date of this ordinance.
- (.05) Operation, maintenance, and repair of irrigation and drainage ditches, constructed ponds, wastewater facilities, stormwater detention or retention facilities, and water facilities consistent with the Stormwater Master Plan or the Comprehensive Plan.
- (.06) Maintenance and repair of streets and utility services within rights-of way, easements, access drives or other previously improved areas.
- (.07) Normal and routine maintenance and repair of any public improvement or public recreational area regardless of its location.
- (.08) The construction of new roads, pedestrian or bike paths into the SROZ in order to provide access to the sensitive area or across the sensitive area, provided the location of the crossing is consistent with the intent of the Wilsonville Comprehensive Plan. Roads and paths shall be constructed so as to minimize and repair disturbance to existing vegetation and slope stability.
- (.09) Maintenance and repair of existing railroad tracks and related improvements.
- (.10) The removal of invasive vegetation such as Himalayan Blackberry, English Ivy, Poison Oak, Scots (Scotch) Broom or as defined as invasive in the Metro Native Plant List.
- (.11) The planting or propagation of any plant identified as native on the Metro Native Plant List. See Wilsonville Planning Division to obtain a copy of this list.
- (.12) Grading for the purpose of enhancing the Significant Resource as approved by the City.
- (.13) Enhancement of the riparian corridor or wetlands for water quality or quantity benefits, fish, or wildlife habitat as approved by the City and other appropriate regulatory authorities.
- (.14) Flood control activities pursuant to the Stormwater Master Plan, save and except those stormwater facilities subject to Class II Administrative Review, as determined by the Planning

Director, to ensure such facilities meet applicable standards under federal, state and local laws, rules and regulations.

(.15) Developments that propose a minor encroachment into the Significant Resource Overlay Zone. The purpose of this adjustment would be to allow for minor encroachments of impervious surfaces such as accessory buildings, eave overhangs, building appurtenances, building access and exiting requirements or other similar feature. The total adjustment shall not exceed 120 square feet in cumulative area.

(.16) The expansion of an existing single family dwelling or duplex not exceeding 600 square feet in area. The expansion of an existing single family dwelling or duplex or structures that are accessory to a single family dwelling or duplex inside the SROZ, provided that the following criteria have been satisfied. An SRIR is not required to evaluate and reach a decision on the issuance of a permit to expand a single-family residence under this paragraph.

A. The expansion of a single family or duplex structure or improvement (including decks and patios) shall not be located any closer to the stream or wetland area than the existing structure or improvement; and

B. The coverage of all structures within the SROZ on the subject parcel shall not be increased by more than 600 square feet, based on the coverage in existence prior to the effective date of this ordinance; and,

C. The applicant must obtain the approval of an erosion and sediment control plan from the City's Building and Environmental Services Divisions; and,

D. No part of the expansion is located within the Metro UGMFP Title 3 Water Quality Area.

(.17) New Single-Family Dwelling or Duplex. The construction of a new single family dwelling or duplex, including a duplex created through conversion of an existing detached single-family dwelling, is exempt unless the building encroaches into the Impact Area and/or the SROZ.

A. If the proposed building encroaches only into the Impact Area then an abbreviated SRIR may be required as specified in Section 4.139.05, unless it can be clearly determined by the Planning Director that the development proposal will have no impact on the Significant Resource. The primary purpose of the Impact Area is to insure that development does not encroach into the SROZ. Development otherwise in compliance with the Planning and Land Development Ordinance may be authorized within the Impact Area.

B. If the proposed building encroaches into the SROZ, then a complete or abbreviated SRIR report is required.

(.18) Private or public service connection laterals and service utility extensions.

(.19) A Stage II development permit or other development permits issued by the City and approved prior to the effective date of this ordinance.

(.20) The installation of public streets and utilities specifically mapped within a municipal utility master plan, the Transportation Systems Plan or a capital improvement plan.

(.21) Structures which are non-conforming to the standards of this Section may be re-built in the event of damage due to fire or other natural hazard subject to Sections 4.189—4.192 of the Planning and Land Development Ordinance, provided that the structure is placed within the same foundation lines (See Figure NR-6.). An SRIR is not required to evaluate and reach a decision on the issuance of a permit to replace a structure subject to this paragraph.

(.22) Any impacts to resource functions from the above excepted activities, such as gravel construction pads, erosion/sediment control materials or damaged vegetation, shall be mitigated using appropriate repair or restoration/enhancement techniques.

Response: No impacts are proposed to the area within the SROZ. The standards of this section are not applicable.

Section 4.139.05. - Significant Resource Overlay Zone Map Verification.

The map verification requirements described in this Section shall be met at the time an applicant requests a building permit, grading permit, tree removal permit, land division approval, or other land use decision. Map verification shall not be used to dispute whether the mapped Significant Resource Overlay Zone boundary is a significant natural resource. Map refinements are subject to the requirements of Section 4.139.10(.01)(D).

(.01) In order to confirm the location of the Significant Resource Overlay Zone, map verification shall be required or allowed as follows:

A. Development that is proposed to be either in the Significant Resource Overlay Zone or less than 100 feet outside of the boundary of the Significant Resource Overlay Zone, as shown on the Significant Resource Overlay Zone Map.

B. A lot or parcel that:

1. Either contains the Significant Resource Overlay Zone, or any part of which is less than 100 feet outside the boundary of the Significant Resource Overlay Zone, as shown on the Significant Resource Overlay Zone Map; and

2. Is the subject of a land use application for a partition, subdivision, or any land use application that the approval of which would authorize new development on the subject lot or parcel.

(.02) An application for Significant Resource Overlay Zone Map Verification may be submitted even if one is not required pursuant to Section 4.139.05(.01).

(.03) If a lot or parcel or parcel is subject to Section 4.139.05(.01), an application for Significant Resource Overlay Zone Map Verification shall be filed concurrently with the other land use applications referenced in Section 4.139.05(.01)(B)(2) unless a previously approved Significant Resource Overlay Zone Map Verification for the subject property remains valid.

(.04) An applicant for Significant Resource Overlay Zone Map Verification shall use one or more of the following methods to verify the Significant Resource Overlay Zone boundary:

A. The applicant may concur with the accuracy of the Significant Resource Overlay Zone Map of the subject property;

B. The applicant may demonstrate a mapping error was made in the creation of the Significant Resource Overlay Zone Map; and

C. The applicant may demonstrate that the subject property was developed lawfully prior to June 7, 2001.

(.05) The Planning Director shall determine the location of any Significant Resource Overlay Zone on the subject property by considering information submitted by the applicant, information collected during any site visit that may be made to the subject property, information generated by Significant Resource Overlay Zone Map Verification that has occurred on adjacent properties, and any other relevant information that has been provided.

(.06) For applications filed pursuant to Section 4.139.05(.04)(A) and (C), a Significant Resource Overlay Zone Map Verification shall be consistent with the submittal requirements listed under Section 4.139.06(.01)(B-H).

(.07) For applications filed pursuant to Section 4.139.05(.04)(B), a Significant Resource Overlay Zone Map Verification shall be consistent with the submittal requirements listed under Section 4.139.06(.02)(D)(1).

Response: The application materials include the SROZ boundary as shown in Exhibit E. No change in the SROZ boundary is proposed with this application.

Site Design Review

Section 4.154. On-site Pedestrian Access and Circulation

(.01) On-site Pedestrian Access and Circulation

- A. *The purpose of this section is to implement the pedestrian access and connectivity policies of the Transportation System Plan. It is intended to provide for safe, reasonably direct, and convenient pedestrian access and circulation.*
- B. *Standards. Development shall conform to all of the following standards:*
1. *Continuous Pathway System. A pedestrian pathway system shall extend throughout the development site and connect to adjacent sidewalks, and to all future phases of the development, as applicable.*
 2. *Safe, Direct, and Convenient. Pathways within developments shall provide safe, reasonably direct, and convenient connections between primary building entrances and all adjacent parking areas, recreational areas/playgrounds, and public rights-of-way and crosswalks based on all of the following criteria:*
 - a. *Pedestrian pathways are designed primarily for pedestrian safety and convenience, meaning they are free from hazards and provide a reasonably smooth and consistent surface.*
 - b. *The pathway is reasonably direct. A pathway is reasonably direct when it follows a route between destinations that does not involve a significant amount of unnecessary out-of-direction travel.*
 - c. *The pathway connects to all primary building entrances and is consistent with the Americans with Disabilities Act (ADA) requirements.*
 - d. *All parking lots larger than three acres in size shall provide an internal bicycle and pedestrian pathway pursuant to Section 4.155(.03)(B.)(3.)(d.).*

Response: As illustrated on Sheets C2 and C3 of Exhibit E, the existing pedestrian circulation will be maintained with the proposed development. Per discussions with Staff, pedestrian connection to SW 5th Street, along the new driveway, is not required or proposed given that the new driveway will be used for truck-trailer traffic and not passenger vehicle/pedestrian movement.

3. *Vehicle/Pathway Separation. Except as required for crosswalks, per subsection 4, below, where a pathway abuts a driveway or street it shall be vertically or horizontally separated from the vehicular lane. For example, a pathway may be vertically raised six inches above the abutting travel lane, or horizontally separated by a row of bollards.*

Response: Areas where the pedestrian path abuts the vehicle circulation area (striped areas on Sheets C2 and C3 of Exhibit E) will be horizontally separated by a row of bollards to enhance pedestrian safety. This standard is met.

4. *Crosswalks. Where a pathway crosses a parking area or driveway, it shall be clearly marked with contrasting paint or paving materials (e.g., pavers, light-color concrete inlay between asphalt, or similar contrast).*

Response: Areas where the pedestrian path crosses a parking area will be marked with contrasting paint as shown on Sheets C2 and C3 of Exhibit E. This standard is met.

5. *Pathway Width and Surface. Primary pathways shall be constructed of concrete, asphalt, brick/masonry pavers, or other durable surface, and not less than five (5) feet wide. Secondary pathways and pedestrian trails may have an alternative surface except as otherwise required by the ADA.*

6. *All pathways shall be clearly marked with appropriate standard signs.*

Response: The pathway will be hard surfaced with the same material as the parking area and will measure a minimum of 5' in width. The pathways will be marked with appropriate signage which will be detailed at time of permitting.

Section 4.155. General Regulations - Parking, Loading and Bicycle Parking

(.02) *General Provisions:*

A. *The provision and maintenance of off-street parking spaces is a continuing obligation of the property owner. The standards set forth herein shall be considered by the Development Review Board as minimum criteria.*

1. *The Board shall have the authority to grant variances or planned development waivers to these standards in keeping with the purposes and objectives set forth in the Comprehensive Plan and this Code.*

2. *Waivers to the parking, loading, or bicycle parking standards shall only be issued upon a findings that the resulting development will have no significant adverse impact on the surrounding neighborhood, and the community, and that the development considered as a whole meets the purposes of this section.*

Response: The applicant acknowledges the continuing obligation to provide and maintain parking for site users. No waivers are requested as part of this application. This standard is met.

B. *No area shall be considered a parking space unless it can be shown that the area is accessible and usable for that purpose, and has maneuvering area for the vehicles, as determined by the Planning Director.*

Response: As illustrated on Sheets C2 and C3 in Exhibit E, all proposed parking spaces will be hard surfaced as required, and off-street maneuvering space is provided in drive aisles that provide for safe and efficient circulation of vehicles. This standard is met.

C. *In cases of enlargement of a building or a change of use from that existing on the effective date of this Code, the number of parking spaces required shall be based on the additional floor area of the enlarged or additional building, or changed use, as set forth in this Section. Current development standards, including parking area landscaping and screening, shall apply only to the additional approved parking area.*

Response: No building enlargement or change of use is proposed. This standard does not apply.

D. *In the event several uses occupy a single structure or parcel of land, the total requirement for off-street parking shall be the sum of the requirements of the several uses computed separately, except as modified by subsection "E," below.*

Response: The proposed parking lot will serve OrePac's existing warehousing and manufacturing uses on the larger OrePac Site. Pursuant to the City of Wilsonville's response to OAR 660-012-0440, the subject site is located in an area of the City which is exempt from the minimum parking requirements. The Manufacturing use does not have a maximum parking ratio, per *Table 5: Parking Standards* of the Wilsonville Development Code. There are no minimum or maximum parking ratios for this proposed site. There are a total of 131 approved parking spaces on the larger OrePac site. An additional 98 parking spaces are proposed as part of these site improvements, resulting in 229 total parking spaces. A tabulation of the existing and proposed parking is included on Sheet C2 of Exhibit E. This standard is met.

E. *Owners of two (2) or more uses, structures, or parcels of land may utilize jointly the same parking area when the peak hours of operation do not overlap, provided satisfactory legal evidence is presented in the form of deeds, leases, or contracts securing full and permanent access to such parking areas for all the parties jointly using them.*

Response: At the time the ROW vacation is completed, the 31' wide current ROW corridor will return to tax lot 701. As shown on Sheet C2 and C3 of Exhibit E, the proposed southern parking area is located on both tax lot 701 and 101. The applicant will provide a shared parking agreement,

prior to time of permit issuance, to allow for the parking of vehicles on tax lot 101, for the benefit of tax lot 701. This standard is met.

- F. *Off-street parking spaces existing prior to the effective date of this Code may be included in the amount necessary to meet the requirements in case of subsequent enlargement of the building or use to which such spaces are necessary.*

Response: No new building, or building enlargement is proposed as part of this application. This standard is not applicable.

- G. *Off-Site Parking. Except for single-family dwellings, the vehicle parking spaces required by this Chapter may be located on another parcel of land, provided the parcel is within 500 feet of the use it serves and the DRB has approved the off-site parking through the Land Use Review. The distance from the parking area to the use shall be measured from the nearest parking space to the main building entrance, following a sidewalk or other pedestrian route. The right to use the off-site parking must be evidenced in the form of recorded deeds, easements, leases, or contracts securing full and permanent access to such parking areas for all the parties jointly using them.*

Response: The parking area is to serve the manufacturing use on tax lot 701. The parking area is within 500' of the manufacturing building on tax lot 701. At the time the ROW vacation is completed, the 31' wide current ROW corridor will return to tax lot 701. As shown on Sheet C2 and C3 of Exhibit E, the proposed southern parking area is located on both tax lot 701 and 101. The applicant will provide a shared parking agreement, prior to time of permit issuance, to allow for the parking of vehicles on tax lot 101, for the benefit of tax lot 701. This standard is met.

- H. *The conducting of any business activity shall not be permitted on the required parking spaces, unless a temporary use permit is approved pursuant to Section 4.163.*

Response: The applicant is not requesting authorization to perform business activities within the required parking spaces. This standard does not apply.

- I. *Where the boundary of a parking lot adjoins or is within a residential district, such parking lot shall be screened by a sight-obscuring fence or planting. The screening shall be continuous along that boundary and shall be at least six (6) feet in height.*

Response: The parking lot is not within, or adjoins, a residential district. As shown on the Zoning Map (Exhibit C), the area to the south is zoning Future Development Agricultural Holding – Industrial (FDAHI), the area to the north is zoned Planned Development Industrial (PDI), the area to the east is the Portland & Western Railroad (with Planned Development Industrial (PDI), Planned Development Commercial (PDC), and Future Development Agricultural Holding Commercial (FDAHC) located east of the Railroad corridor), and to the west is zoning Planned Development Industrial (PDI). None of these zones are a residential district, so this standard does not apply, and no parking lot screening is required under this provision.

- J. *Parking spaces along the boundaries of a parking lot shall be provided with a sturdy bumper guard or curb at least six (6) inches high and located far enough within the boundary to prevent any portion of a car within the lot from extending over the property line or interfering with required screening or sidewalks.*

Response: As illustrated on Sheets C2 and C3 of Exhibit E, all parking spaces adjacent to the boundaries of the parking lot have a 6" curb at the front to ensure adequate space for landscaping and sidewalks. The parking lot is not located adjacent to any sidewalks or property lines. This standard is met.

- K. *All areas used for parking and maneuvering of cars shall be surfaced with asphalt, concrete, or other surface, such as pervious materials (i. e. pavers, concrete, asphalt) that*

is found by the City's authorized representative to be suitable for the purpose. In all cases, suitable drainage, meeting standards set by the City's authorized representative, shall be provided.

Response: As noted on Sheets C2 and C3 of Exhibit E, all parking and maneuvering areas are proposed to be paved. Sheet C3 of Exhibit E illustrates the required stormwater management system. This standard is met.

L. *Artificial lighting which may be provided shall be so limited or deflected as not to shine into adjoining structures or into the eyes of passers-by.*

Response: As illustrated on the lighting plan (see Exhibits G and H), the applicant intends to comply using the performance approach. This standard is met.

M. *Off-street parking requirements for types of uses and structures not specifically listed in this Code shall be determined by the Development Review Board if an application is pending before the Board. Otherwise, the requirements shall be specified by the Planning Director, based upon consideration of comparable uses.*

Response: Parking standards for the existing uses are listed in this Code. No additional building area is being proposed as part of this application.

N. *Up to forty percent (40%) of the off-street spaces may be compact car spaces as identified in Section 4.001 - "Definitions," and shall be appropriately identified.*

Response: As illustrated on Sheet C2 in Exhibit E, 20 of the 98 (20%) new parking spaces are proposed to be compact. The compact parking spaces meet the dimensional standards as prescribed in Section 4.001. This standard is met.

O. *Where off-street parking areas are designed for motor vehicles to overhang beyond curbs, planting areas adjacent to said curbs shall be increased to a minimum of seven (7) feet in depth. This standard shall apply to a double row of parking, the net effect of which shall be to create a planted area that is a minimum of seven (7) feet in depth.*

Response: As shown on Sheet L1.10 of Exhibit E, no planting areas are located in areas that are designed for motor vehicles to overhang beyond curbs. This standard is not applicable.

(.03) Minimum and Maximum Off-Street Parking Requirements:

A. *Parking and loading or delivery areas shall be designed with access and maneuvering area adequate to serve the functional needs of the site and shall:*

1. *Separate loading and delivery areas and circulation from customer and/or employee parking and pedestrian areas. Circulation patterns shall be clearly marked.*
2. *To the greatest extent possible, separate vehicle and pedestrian traffic.*

Response: The proposed parking lot will serve OrePac's existing warehousing and manufacturing uses on the larger OrePac Site. The new parking lot configuration and dimensions have been designed for use by passenger vehicles. As shown on Sheets C2 and C3 of Exhibit E, the parking area offers three (3) rows of parking, with two (2) rows accessed by a two-way drive aisle measuring 24' in width and the third row of parking (45-degree angled parking spaces) accessed by a 11' drive aisle with pavement marking indicating the circulation pattern. The proposed parking lot is separated from the loading and delivery areas of the site. This standard is met.

B. *Parking and loading or delivery areas shall be landscaped to minimize the visual dominance of the parking or loading area, as follows:*

1. *Landscaping of at least ten percent (10%) of the parking area designed to be screened from view from the public right-of-way and adjacent properties. This*

landscaping shall be considered to be part of the fifteen percent (15%) total landscaping required in Section 4.176.03 for the site development.

Response: As shown on Sheet L0.01 of Exhibit E, the parking lot will have a landscaping area of 34%. The proposed parking lot is located 250' from the railroad tracks to the east and 250' from the nearest point of SW 5th Street. Parking area landscape areas have been counted as contributing to overall site landscaping, consistent with this provision. Compliance with the 15% total landscaping requirement is discussed in the Applicant's response to Section 4.176.03.

2. *Landscape tree planting areas shall be a minimum of eight (8) feet in width and length and spaced every eight (8) parking spaces or an equivalent aggregated amount.*

a. *Trees shall be planted in a ratio of one (1) tree per eight (8) parking spaces or fraction thereof, except in parking areas of more than two hundred (200) spaces where a ratio of one (1) tree per six (six) spaces shall be applied as noted in subsection (.03)(B.)(3.). A landscape design that includes trees planted in areas based on an aggregated number of parking spaces must provide all area calculations.*

b. *Except for trees planted for screening, all deciduous interior parking lot trees must be suitably sized, located, and maintained to provide a branching minimum of seven (7) feet clearance at maturity.*

Response: As illustrated on Sheet L1.10 of Exhibit B, landscape tree plantings occur at an equivalent aggregated amount of every eight (8) parking spaces, and planter islands are at least 8' in width and length. Interior parking lot trees are listed on Sheet L0.01 of Exhibit E; these trees have a mature height of 50' to 70' and mature width of 50'. This standard is met.

3. *Due to their large amount of impervious surface, new development with parking areas of more than two hundred (200) spaces that are located in any zone, and that may be viewed from the public right of way, shall be landscaped to the following additional standards:*

Response: As illustrated on Sheets C2 and C3 of Exhibit E, 98 parking spaces are proposed, which is fewer than 200 parking spaces. This standard does not apply.

C. *Off Street Parking shall be designed for safe and convenient access that meets ADA and ODOT standards. All parking areas which contain ten (10) or more parking spaces, shall for every fifty (50) standard spaces., provide one ADA-accessible parking space that is constructed to building code standards, Wilsonville Code 9.000.*

Response: As illustrated on Sheets C2 and C3 of Exhibit E, 98 new vehicle parking spaces are proposed, in addition to the existing 131 parking spaces (229 parking spaces total). Accordingly, seven (7) ADA parking spaces are required. As shown on Sheet C1 of Exhibit E, the existing parking area will be partially restriped to include a total of seven (7) ADA parking spaces. Staff has concurred on the applicant's approach of providing all the ADA parking spaces nearest to the building's main entrance, instead of in the proposed parking area. Specific compliance with the standards of the ADA and Oregon Structural Specialty Code will be demonstrated at time of permitting. This standard is met.

D. *Where possible, parking areas shall be designed to connect with parking areas on adjacent sites so as to eliminate the necessity for any mode of travel of utilizing the public street*

for multiple accesses or cross movements. In addition, on-site parking shall be designed for efficient on-site circulation and parking.

Response: As illustrated on Sheets C2 and C3 of Exhibit E, the new parking lot is adjacent to an existing industrial site. These two (2) sites will be connected by a drive aisle to allow efficient circulation between similar operations without utilizing public streets. This standard is met.

E. In all multi-family dwelling developments, there shall be sufficient areas established to provide for parking and storage of motorcycles, mopeds and bicycles. Such areas shall be clearly defined and reserved for the exclusive use of these vehicles.

Response: No multi-family residences are proposed as part of this development. This standard does not apply.

F. On-street parking spaces, directly adjoining the frontage of and on the same side of the street as the subject property, may be counted towards meeting the minimum off-street parking standards.

Response: No on-street parking is proposed. This standard does not apply.

G. Table 5 shall be used to determine the minimum and maximum parking standards for various land uses. The minimum number of required parking spaces shown on Tables 5 shall be determined by rounding to the nearest whole parking space. For example, a use containing 500 square feet, in an area where the standard is one space for each 400 square feet of floor area, is required to provide one off-street parking space. If the same use contained more than 600 square feet, a second parking space would be required. Structured parking and on-street parking are exempted from the parking maximums in Table 5.

Response: The proposed parking lot will serve OrePac's existing warehousing and manufacturing uses on the larger OrePac Site. Pursuant to the City of Wilsonville's response to OAR 660-012-0440, the subject site is located in an area of the City which is exempt from the minimum parking requirements. The Manufacturing use does not have a maximum parking ratio, per *Table 5: Parking Standards* of the Wilsonville Development Code. There are no minimum or maximum parking ratios for this proposed site. There are a total of 131 approved parking spaces on the larger OrePac site. An additional 98 parking spaces will be located in the southern parking area as shown on Sheets C2 and C3 of Exhibit E, resulting in a total of 229 parking spaces. This standard is met.

H. Electrical Vehicle Charging Stations:

- 1. Parking spaces designed to accommodate and provide one or more electric vehicle charging stations on site may be counted towards meeting the minimum off-street parking standards.*
- 2. Modification of existing parking spaces to accommodate electric vehicle charging stations on site is allowed outright.*

Response: Per guidance received from DLCD, the State's Electric Vehicle rule only applies to new parking areas on the same site **AND** serving a newly constructed building. As no new building area is being proposed, electrical vehicle ready parking spaces are not required. This standard is not applicable.

I. Motorcycle parking:

- 1. Motorcycle parking may substitute for up to 5 spaces or 5 percent of required automobile parking, whichever is less. For every 4 motorcycle parking spaces provided, the automobile parking requirement is reduced by one space.*

2. *Each motorcycle space must be at least 4 feet wide and 8 feet deep. Existing parking may be converted to take advantage of this provision.*

Response: As shown on Sheet C2 of Exhibit E, four (4) motorcycle parking spaces are proposed. The motorcycle parking spaces are not intended to replace the required automobile parking. The motorcycle parking spaces measure 4' wide and 8' deep as shown on Sheet C2 of Exhibit E. This standard is met.

(.04) *Bicycle Parking:*

A. *Required Bicycle Parking - General Provisions.*

1. *The required minimum number of bicycle parking spaces for each use category is shown in Table 5, Parking Standards.*
2. *Bicycle parking spaces are not required for accessory buildings. If a primary use is listed in Table 5, bicycle parking is not required for the accessory use.*
3. *When there are two or more primary uses on a site, the required bicycle parking for the site is the sum of the required bicycle parking for the individual primary uses.*
4. *Bicycle parking space requirements may be waived by the Development Review Board per Section 4.118(.03)(A.)(9.) and (10.).*

Response: As no new building area is proposed as part of the new parking lot development, the requirement for bicycle parking is not triggered. No new bike parking is proposed. This standard is not applicable.

B. *Standards for Required Bicycle Parking*

1. *Each space must be at least 2 feet by 6 feet in area and be accessible without moving another bicycle.*
2. *An aisle at least 5 feet wide shall be maintained behind all required bicycle parking to allow room for bicycle maneuvering. Where the bicycle parking is adjacent to a sidewalk, the maneuvering area may extend into the right-of-way.*
3. *When bicycle parking is provided in racks, there must be enough space between the rack and any obstructions to use the space properly.*
4. *Bicycle lockers or racks, when provided, shall be securely anchored.*
5. *Bicycle parking shall be located within 30 feet of the main entrance to the building or inside a building, in a location that is easily accessible for bicycles. For multi-tenant developments, with multiple business entrances, bicycle parking may be distributed on-site among more than one main entrance.*

Response: As no new building area is proposed as part of the new parking lot development, the requirement for bicycle parking is not triggered. No new bike parking is proposed. This standard is not applicable.

C. *Long-term Bicycle Parking*

1. *Long-term bicycle parking provides employees, students, residents, commuters, and others who generally stay at a site for several hours a weather-protected place to park bicycles.*
2. *For a proposed multi-family residential, retail, office, or institutional development, or for a park and ride or transit center, where six (6) or more bicycle parking spaces are required pursuant to Table 5, 50% of the bicycle parking shall be developed as long-term, secure spaces. Required long-term bicycle parking shall meet the following standards:*
 - a. *All required spaces shall meet the standards in subsection (B.) above, and must be covered in one of the following ways: inside buildings, under roof*

overhangs or permanent awnings, in bicycle lockers, or within or under other structures.

- b. All spaces must be located in areas that are secure or monitored (e.g., visible to employees, monitored by security guards, or in public view).*
- c. Spaces are not subject to the locational criterion of (B.)(5.).*

Response: As no new building area is proposed as part of the new parking lot development, the requirement for bicycle parking is not triggered. No new bike parking is proposed. This standard is not applicable.

(.05) Minimum Off-Street Loading Requirements:

Response: As no new building area is proposed as part of the new parking lot development, the requirement for loading spaces is not triggered. No new loading spaces are proposed. This standard is not applicable.

(.06) Carpool and Vanpool Parking Requirements:

- A. Carpool and vanpool parking spaces shall be identified for the following uses:*
 - 1. New commercial and industrial developments with seventy-five (75) or more parking spaces,*
 - 2. New institutional or public assembly uses, and*
 - 3. Transit park-and-ride facilities with fifty (50) or more parking spaces.*
- B. Of the total spaces available for employee, student, and commuter parking, at least five percent, but not fewer than two, shall be designated for exclusive carpool and vanpool parking.*
- C. Carpool and vanpool parking spaces shall be located closer to the main employee, student or commuter entrance than all other parking spaces with the exception of ADA parking spaces.*
- D. Required carpool/vanpool spaces shall be clearly marked "Reserved - Carpool/Vanpool Only."*

Response: As shown on Sheet C2 of Exhibit E, 98 new parking spaces are proposed. According, 12 Carpool/Vanpool Only parking stalls are included as shown on Sheet C2 of Exhibit E. The Carpool/Vanpool Only parking stalls are located closer to the main building entrances than all other parking spaces, except for ADA parking spaces. The stalls will be clearly marked, as will be demonstrated at time of permitting. This standard is met.

(.07) Parking Area Redevelopment. The number of parking spaces may be reduced by up to 10% of the minimum required parking spaces for that use when a portion of the existing parking area is modified to accommodate or provide transit-related amenities such as transit stops, pull-outs, shelters, and park and ride stations.

Response: The applicant is not proposing a parking reduction for transit-related amenities. This standard does not apply.

Section 4.171. General Regulations - Protection of Natural Features and Other Resources

(.02) General Terrain Preparation:

- A. All developments shall be planned, designed, constructed and maintained with maximum regard to natural terrain features and topography, especially hillside areas, floodplains, and other significant landforms.*
- B. All grading, filling and excavating done in connection with any development shall be in accordance with the Uniform Building Code*

- C. *In addition to any permits required under the Uniform Building Code, all developments shall be planned, designed, constructed and maintained so as to:*
1. *Limit the extent of disturbance of soils and site by grading, excavation and other land alterations.*
 2. *Avoid substantial probabilities of: (1) accelerated erosion; (2) pollution, contamination, or siltation of lakes, rivers, streams and wetlands; (3) damage to vegetation; (4) injury to wildlife and fish habitats.*
 3. *Minimize the removal of trees and other native vegetation that stabilize hillsides, retain moisture, reduce erosion, siltation and nutrient runoff, and preserve the natural scenic character.*

Response: The site development plan needs to achieve a balance between the purposes of the site's Industrial Comprehensive Plan designation – notably, active industrial use for employment and economic development – and the site's natural topography and resource constraints. The western boundary of the subject property contains a significant creek resource (Coffee Lake Creek) and is partially within the Significant Resource Overlay Zone (SROZ). The applicant proposes a vegetated stormwater facility partially in the SROZ impact area as shown on Sheet C2 of Exhibit E. The applicant will obtain required permits for the grading, filling, and excavation activities. As explained in the Applicant's responses to Section 4.600, a Type C Tree Removal permit is requested as part of this consolidated land use application. This standard is met.

- (.03) *Hillsides: All developments proposed on slopes greater than 25% shall be limited to the extent that:*
- A. *An engineering geologic study approved by the City, establishes that the site is stable for the proposed development, and any conditions and recommendations based on the study are incorporated into the plans and construction of the development. The study shall include items specified under subsection 4.171(.07)(A.)(2.)(a-j):*
 - B. *Slope stabilization and re-vegetation plans shall be included as part of the applicant's landscape plans.*
 - C. *Buildings shall be clustered to reduce alteration of terrain and provide for preservation of natural features.*
 - D. *Creation of building sites through mass pad grading and successive padding or terracing of building sites shall be avoided where feasible.*
 - E. *Roads shall be of minimum width, with grades consistent with the City's Public Works Standards.*
 - F. *Maintenance, including re-vegetation, of all grading areas is the responsibility of the developer, and shall occur through October 1 of the second growing season following receipt of Certificates of Occupancy unless a longer period is approved by the Development Review Board.*
 - G. *The applicant shall obtain an erosion and sediment control permit from the City's Building and Environmental Services Division's.*

Response: No development is proposed on slopes greater than 25%. This standard is not applicable.

- (.04) *Trees and Wooded Areas.*
- A. *All developments shall be planned, designed, constructed and maintained so that:*
 1. *Existing vegetation is not disturbed, injured, or removed prior to site development and prior to an approved plan for circulation, parking and structure location.*
 2. *Existing wooded areas, significant clumps/groves of trees and vegetation, and all trees with a diameter at breast height of six inches or greater shall be incorporated into the development plan and protected wherever feasible.*
 3. *Existing trees are preserved within any right-of-way when such trees are suitably located, healthy, and when approved grading allows.*

Response: Existing vegetation will not be disturbed prior to the approval of the site development permits. As explained in the Applicant’s responses to Section 4.600, a Type C Tree Removal permit is requested as part of this consolidated land use application. This standard is met.

B. Trees and woodland areas to be retained shall be protected during site preparation and construction according to City Public Works design specifications, by:

1. Avoiding disturbance of the roots by grading and/or compacting activity.

Response: As illustrated on Sheet L5.10 of Exhibit E, tree protection measures will be installed to protect root zones for trees to be conserved. This standard is met.

2. Providing for drainage and water and air filtration to the roots of trees which will be covered with impermeable surfaces.

Response: No trees are proposed for retention at locations where their root zones would be covered by impermeable surfaces; this provision is not applicable.

3. Requiring, if necessary, the advisory expertise of a registered arborist/horticulturist both during and after site preparation.

Response: Arborist consultation can be required on-site as excavation and grading are done, to assess root damage and make determinations with respect to trees affected by grading, and site improvements. Compliance can be assured through a condition of approval.

4. Requiring, if necessary, a special maintenance, management program to insure survival of specific woodland areas of specimen trees or individual heritage status trees.

Response: The site does not contain uniquely valuable specimen trees or heritage status trees; this requirement is not applicable.

(.05) High Voltage Powerline Easements and Rights of Way and Petroleum Pipeline Easements:

A. Due to the restrictions placed on these lands, no residential structures shall be allowed within high voltage powerline easements and rights of way and petroleum pipeline easements, and any development, particularly residential, adjacent to high voltage powerline easements and rights of way and petroleum pipeline easements shall be carefully reviewed.

B. Any proposed non-residential development within high voltage powerline easements and rights of way and petroleum pipeline easements shall be coordinated with and approved by the Bonneville Power Administration, Portland General Electric Company or other appropriate utility, depending on the easement or right of way ownership.

Response: A 25' wide Bonneville Power Administration (BPA) electrical transmission line easement runs the north/south length of the property along the property boundary with the Oregon Electric Railroad to the east. Proposed development with the 25' wide BPA includes a driveway, rain garden, and stormwater conveyance systems. The Applicant has coordinated the proposed design with BPA, and will provide BPA coordination documentation when received from BPA.

(.06) Hazards to Safety: Purpose:

A. To protect lives and property from natural or human-induced geologic or hydrologic hazards and disasters.

B. To protect lives and property from damage due to soil hazards.

C. To protect lives and property from forest and brush fires.

D. To avoid financial loss resulting from development in hazard areas.

(.07) *Standards for Earth Movement Hazard Areas:*

- A. *No development or grading shall be allowed in areas of land movement, slump or earth flow, and mud or debris flow, except under one of the following conditions:*
 - 1. *Stabilization of the identified hazardous condition based on established and proven engineering techniques which ensure protection of public and private property. Appropriate conditions of approval may be attached by the City.*
 - 2. *An engineering geologic study approved by the City establishing that the site is stable for the proposed use and development. The study shall include the following:*
 - a. *Index map.*
 - b. *Project description, to include: location; topography, drainage, vegetation; discussion of previous work; and discussion of field exploration methods.*
 - c. *Site geology, to include: site geologic map; description of bedrock and superficial materials including artificial fill; location of any faults, folds, etc.; and structural data including bedding, jointing, and shear zones.*
 - d. *Discussion and analysis of any slope stability problems.*
 - e. *Discussion of any off-site geologic conditions that may pose a potential hazard to the site or that may be affected by on-site development.*
 - f. *Suitability of site for proposed development from geologic standpoint.*
 - g. *Specific recommendations for cut slope stability, seepage and drainage control, or other design criteria to mitigate geologic hazards.*
 - h. *Supportive data, to include: cross sections showing subsurface structure; graphic logs of subsurface explorations; results of laboratory tests; and references.*
 - i. *Signature and certification number of engineering geologist registered in the State of Oregon.*
 - j. *Additional information or analyses as necessary to evaluate the site.*
- B. *Vegetative cover shall be maintained or established for stability and erosion control purposes.*
- C. *Diversion of storm water into these areas shall be prohibited.*
- D. *The principal source of information for determining earth movement hazards is the State Department of Geology and Mineral Industries (DOGAMI) Bulletin 99 and any subsequent bulletins and accompanying maps. Approved site specific engineering geologic studies shall be used to identify the extent and severity of the hazardous conditions on the site, and to update the earth movement hazards database.*

Response: According to data from the Oregon Department of Geology and Minerals (DOGAMI)¹, the subject site is located within a landslide hazard area (“Moderate – Landsliding Possible”), but there are no known active fault lines in the immediate vicinity. Furthermore, site-specific geotechnical investigation and construction recommendations (see Exhibit F) did not identify landslide potential. The contractor will not begin clearing operations until appropriate erosion and sedimentation control permits and grading permits have been issued by the City and the Oregon Department of Environmental Quality, to ensure that adequate measures will be in place to minimize erosion potential. The proposed stormwater system, illustrated on Sheet C3 of Exhibit B, has been designed based on the findings and specific recommendations in the Geotechnical Report (see Exhibit F); it will collect on-site stormwater runoff, direct it through surface water quality treatment facilities, and outfall to the existing public storm drain system in the SW 5th Street right-of-way. The L-shaped parking area will include a rain garden for the east

¹ <https://gis.dogami.oregon.gov/maps/hazvu/>

portion of the L-shaped parking area and an infiltration chamber system for the west portion of the parking L-shaped parking area. A Storm Report is included as Exhibit F. This standard is met.

(.08) Standards for Soil Hazard Areas:

- A. *Appropriate siting and design safeguards shall insure structural stability and proper drainage of foundation and crawl space areas for development on land with any of the following soil conditions: wet or high water table; high shrink-swell capability; compressible or organic; and shallow depth-to-bedrock.*

The principal source of information for determining soil hazards is the State DOGAMI Bulletin 99 and any subsequent bulletins and accompanying maps. Approved site-specific soil studies shall be used to identify the extent and severity of the hazardous conditions on the site, and to update the soil hazards database accordingly.

Response: In the Preliminary Storm Report (see Exhibit F), the applicant has provided documentation of fair soil infiltration characteristics at the subject property Geotechnical Consultation and Field Infiltration Testing Services, November 1, 2023). All construction will be based on recommendations by the consulting geological engineer to ensure structural stability. Based on the geological engineer's findings and recommendations, on-site storm drainage systems have been designed to treat and infiltrate stormwater to the maximum extent feasible, then convey to the public storm facility in SW 5th Street. The applicant's storm report and on-site stormwater management facilities sizing calculations assume infiltration of between 0.5 to 1.0 inches per hour. This assumption is based on the geotechnical engineering report's recommendation. The L-shaped parking area will include a rain garden for both parking areas, and the proposed driveway. The preliminary storm report (Exhibit F) demonstrates the feasibility of meeting stormwater management requirements. This requirement is met.

(.09) Historic Protection: Purpose: [detailed provisions omitted for brevity]

Response: The subject property has not been identified as containing or being adjacent to any significant historic, cultural, or archaeological resources. These provisions are not applicable.

(.10) Alteration and Development Criteria:

- A. *Demolition or alteration of any structure, or any change in any site or object which has been designated as a cultural resource, is prohibited unless it is determined:*

1. *In the case of a designated cultural resource, the proposed work would not detrimentally alter, destroy or adversely affect any exterior architectural or other identified feature; or*
2. *In the case of any property located within a historic district, the proposed construction, removal, rehabilitation, alteration, remodeling, excavation or exterior alteration conforms to any prescriptive standards as adopted by the City, and does not adversely affect the character of the district; or*
3. *In the case of construction of a new improvement, building or structure upon a cultural resource site, the exterior of such improvements will not adversely affect and will be compatible with the external appearance of existing designated improvements, buildings and structures on said site; or*
4. *That no reasonable use can be made of the property without such approval.*

Response: These provisions are not applicable because the subject property is not a designated cultural resource site and is not within a historic district.

(.11) Cultural Resource Designation Criteria: A cultural resource may be designated and placed on the Cultural Resources Inventory if it meets the following criteria:

- A. *It exemplifies or reflects special elements of the City's cultural, social, economic, political, aesthetic, engineering or architectural history; or*
- B. *It is identified with persons or events significant in local, state, or national history; or*
- C. *It embodies distinctive characteristics of a style, type, period, or method of construction, or it is a valuable example of the use of indigenous materials or craftsmanship; or*
- D. *It is representative of the notable work of a builder, designer, or architect.*

Response: These provisions are not applicable because the subject property is not a designated cultural resource site, and it is not proposed for such designation.

Section 4.175. Public Safety and Crime Prevention

(.01) All developments shall be designed to deter crime and insure public safety.

Response: The proposed site plan is designed to provide visibility from other areas of the larger OrePac site. Additionally, the parking lot will be illuminated in accordance with Section 4.199, and will have a 6' chainlink perimeter fence as shown on Sheet C2 of Exhibit E. This standard is met.

(.02) Addressing and directional signing shall be designed to assure identification of all buildings and structures by emergency response personnel, as well as the general public.

Response: No new buildings or structures are proposed. This standard is not applicable.

(.03) Areas vulnerable to crime shall be designed to allow surveillance. Parking and loading areas shall be designed for access by police in the course of routine patrol duties.

Response: The proposed site plan is designed to provide visibility from other areas of the larger OrePac site. Additionally, the parking lot will be illuminated in accordance with Section 4.199 and will have a 6' chainlink perimeter fence as shown on Sheet C2 of Exhibit E. Police would be able to access the OrePac site from SW OrePac Avenue, if necessary. This standard is met.

(.04) Exterior lighting shall be designed and oriented to discourage crime.

Response: As shown on Sheet C2 of Exhibit E, site lighting will illuminate the parking area to enable surveillance and thereby discourage crime. This standard is met.

Section 4.176. Landscaping, Screening, and Buffering

Note: the reader is encouraged to see Section 4.179, applying to screening and buffering of storage areas for solid waste and recyclables.

(.02) Landscaping and Screening Standards.

- B. *Subsections "C" through "I," below, state the different landscaping and screening standards to be applied throughout the City. The locations where the landscaping and screening are required and the depth of the landscaping and screening is stated in various places in the Code.*

Response: The landscape plans in Exhibit E have been designed to conform to the applicable landscaping and screening standards, as described in responses to subsections "C" through "I" below. This standard is met.

- C. *All landscaping and screening required by this Code must comply with all of the provisions of this Section, unless specifically waived or granted a Variance as otherwise provided in the Code. The landscaping standards are minimum requirements; higher standards can be substituted as long as fence and vegetation-height limitations are met. Where the standards set a minimum based on square footage or linear footage, they shall be interpreted as applying to each complete or partial increment of area or length (e.g., a*

landscaped area of between 800 and 1600 square feet shall have two trees if the standard calls for one tree per 800 square feet.

Response: The applicant's landscaping plan, in the L-series drawing sheets of Exhibit E, demonstrates compliance with the standards in this Section.

C. *General Landscaping Standard.*

1. *Intent. The General Landscaping Standard is a landscape treatment for areas that are generally open. It is intended to be applied in situations where distance is used as the principal means of separating uses or developments and landscaping is required to enhance the intervening space. Landscaping may include a mixture of ground cover, evergreen and deciduous shrubs, and coniferous and deciduous trees.*
2. *Required materials. Shrubs and trees, other than street trees, may be grouped. Ground cover plants must fully cover the remainder of the landscaped area (see Figure 21: General Landscaping). The General Landscaping Standard has two different requirements for trees and shrubs:*
 - a. *Where the landscaped area is less than 30 feet deep, one tree is required for every 30 linear feet.*
 - b. *Where the landscaped area is 30 feet deep or greater, one tree is required for every 800 square feet and two high shrubs or three low shrubs are required for every 400 square feet.*

Response: The portion of the Subject Site where development is proposed is over 250' from the nearest road (SW 5th Street). The proposed development improvements consist of a parking area and driveway. As shown on the L-series sheets of Exhibit E, landscaping is provided in accordance with Section 4.176.

D. *Low Screen Landscaping Standard.*

1. *Intent. The Low Screen Landscaping Standard is a landscape treatment that uses a combination of distance and low screening to separate uses or developments. It is intended to be applied in situations where low screening is adequate to soften the impact of one use or development on another, or where visibility between areas is more important than a total visual screen. The Low Screen Landscaping Standard is usually applied along street lot lines or in the area separating parking lots from street rights-of-way.*
2. *Required materials. The Low Screen Landscaping Standard requires sufficient low shrubs to form a continuous screen three (3) feet high and 95% opaque, year-round. In addition, one tree is required for every 30 linear feet of landscaped area, or as otherwise required to provide a tree canopy over the landscaped area. Ground cover plants must fully cover the remainder of the landscaped area. A three (3) foot high masonry wall or a berm may be substituted for the shrubs, but the trees and ground cover plants are still required. When applied along street lot lines, the screen or wall is to be placed along the interior side of the landscaped area. (See Figure 22: Low Screen Landscaping).*

Response: The proposed parking area is not visible from the right-of-way, and the adjacent properties are zone PDI and FDAHI and are under same use as the Subject Site. The portion of the Subject Site where development is proposed is over 250' from the nearest road (SW 5th Street). Low level landscaping standard is not warranted for the proposed parking area.

E. *Low Berm Landscaping Standard.*

1. *Intent. The Low Berm Standard is intended to be applied in situations where moderate screening to reduce both visual and noise impacts is needed to protect abutting uses or developments from one-another, and where it is desirable and practical to provide separation by both distance and sight-obscuring materials. This screening is most important where either, or both, of the abutting uses or developments can be expected to be particularly sensitive to noise or visual impacts.*
2. *Required materials. The Low Berm Standard requires a berm at least two feet six inches (2' 6") high along the interior side of the landscaped area (see Figure 23: Low Berm Landscaping). If the berm is less than three (3) feet high, low shrubs meeting the Low Screen Landscaping Standard, above, are to be planted along the top of the berm, assuring that the screen is at least three (3) feet in height. In addition, one tree is required for every 30 linear feet of berm, or as otherwise required to provide a tree canopy over the landscaped area. Ground cover plants must fully cover the remainder of the landscaped area.*

Response: The proposed parking area is not visible from the right-of-way, and the adjacent properties are zone PDI and FDAHI and are under same use as the Subject Site. The portion of the Subject Site where development is proposed is over 250' from the nearest road (SW 5th Street). Low berm landscaping standard is not warranted for the proposed parking area.

F. High Screen Landscaping Standard.

1. *Intent. The High Screen Landscaping Standard is a landscape treatment that relies primarily on screening to separate uses or developments. It is intended to be applied in situations where visual separation is required.*
2. *Required materials. The High Screen Landscaping Standard requires sufficient high shrubs to form a continuous screen at least six (6) feet high and 95% opaque, year-round. In addition, one tree is required for every 30 linear feet of landscaped area, or as otherwise required to provide a tree canopy over the landscaped area. Ground cover plants must fully cover the remainder of the landscaped area. A six (6) foot high masonry wall or a berm may be substituted for the shrubs, but the trees and ground cover plants are still required. When applied along street lot lines, the screen or wall is to be placed along the interior side of the landscaped area. (See Figure 24: High Screen Landscaping).*

Response: The proposed parking area is not visible from the right-of-way, and the adjacent properties are zone PDI and FDAHI and are under same use as the Subject Site. The portion of the Subject Site where development is proposed is over 250' from the nearest road (SW 5th Street). High screen landscaping standard is not warranted for the proposed parking area.

G. High Wall Standard.

1. *Intent. The High Wall Standard is intended to be applied in situations where extensive screening to reduce both visual and noise impacts is needed to protect abutting uses or developments from one-another. This screening is most important where either, or both, of the abutting uses or developments can be expected to be particularly sensitive to noise or visual impacts, or where there is little space for physical separation.*
2. *Required materials. The High Wall Standard requires a masonry wall at least six (6) feet high along the interior side of the landscaped area (see Figure 25: High Wall Landscaping). In addition, one tree is required for every 30 linear feet of wall, or as otherwise required to provide a tree canopy over the landscaped area. Ground cover plants must fully cover the remainder of the landscaped area.*

Response: The proposed parking area is not visible from the right-of-way, and the adjacent properties are zone PDI and FDAHI and are under same use as the Subject Site. The portion of the Subject Site where development is proposed is over 250' from the nearest road (SW 5th Street). High wall standard is not warranted for the proposed parking area.

I. High Berm Standard.

1. *Intent. The High Berm Standard is intended to be applied in situations where extensive screening to reduce both visual and noise impacts is needed to protect abutting uses or developments from one-another, and where it is desirable and practical to provide separation by both distance and sight- obscuring materials. This screening is most important where either, or both, of the abutting uses or developments can be expected to be particularly sensitive to noise or visual impacts.*
2. *Required materials. The High Berm Standard requires a berm at least four (4) feet high along the interior side of the landscaped area (see Figure 26: High Berm Landscaping). If the berm is less than six (6) feet high, low shrubs meeting the Low Screen Landscaping Standard, above, are to be planted along the top of the berm, assuring that the screen is at least six (6) feet in height In addition, one tree is required for every 30 linear feet of berm, or as otherwise required to provide a tree canopy over the landscaped area. Ground cover plants must fully cover the remainder of the landscaped area.*

Response: The proposed parking area is not visible from the right-of-way, and the adjacent properties are zone PDI and FDAHI and are under same use as the Subject Site. The portion of the Subject Site where development is proposed is over 250' from the nearest road (SW 5th Street). High berm landscaping standard is not warranted for the proposed parking area.

J. Partially Sight-Obscuring Fence Standard.

1. *Intent. The Partially Sight-Obscuring Fence Standard is intended to provide a tall, but not totally blocked, visual separation. The standard is applied where a low level of screening is adequate to soften the impact of one use or development on another, and where some visibility between abutting areas is preferred over a total visual screen. It can be applied in conjunction with landscape plantings or applied in areas where landscape plantings are not necessary and where nonresidential uses are involved.*
2. *Required materials. Partially Sight-Obscuring Fence Standard are to be at least six (6) feet high and at least 50% sight-obscuring. Fences may be made of wood (other than plywood or particle-board), metal, bricks, masonry or other permanent materials (see Figure 27: Partially Sight-Obscuring Fence).*

Response: The proposed parking area is not visible from the right-of-way, and the adjacent properties are zone PDI and FDAHI and are under same use as the Subject Site. The portion of the Subject Site where development is proposed is over 250' from the nearest road (SW 5th Street). A partially sight-obscuring fence standard is not warranted for the proposed parking area.

K. Fully Sight-Obscuring Fence Standard.

1. *Intent. The Fully Sight-Obscuring Fence Standard is intended to provide a totally blocked visual separation. The standard is applied where full visual screening is needed to reduce the impact of one use or development on another. It can be applied in conjunction with landscape plantings or applied in areas where landscape plantings are not necessary.*

2. *Required materials. Fully sight-obscuring fences are to be at least six (6) feet high and 100% sight-obscuring. Fences may be made of wood (other than plywood or particle-board), metal, bricks, masonry or other permanent materials (see Figure 28: Totally Sight-Obscuring Fence).*

Response: The proposed parking area is not visible from the right-of-way, and the adjacent properties are zone PDI and FDAHI and are under same use as the Subject Site. The portion of the Subject Site where development is proposed is over 250' from the nearest road (SW 5th Street). A fully sight-obscuring fence standard is not warranted for the proposed parking area.

(.03) Landscape Area. Not less than fifteen percent (15%) of the total lot area, shall be landscaped with vegetative plant materials. The ten percent (10%) parking area landscaping required by section 4.155.03(B)(1) is included in the fifteen percent (15%) total lot landscaping requirement. Landscaping shall be located in at least three separate and distinct areas of the lot, one of which must be in the contiguous frontage area. Planting areas shall be encouraged adjacent to structures. Landscaping shall be used to define, soften or screen the appearance of buildings and off-street parking areas. Materials to be installed shall achieve a balance between various plant forms, textures, and heights. The installation of native plant materials shall be used whenever practicable. (For recommendations refer to the Native Plant List maintained by the City of Wilsonville). [Amended by Ord. # 674 11/16/09]

Response: As shown on the L-series sheets of Exhibit E, 220,681 SF of landscaping is provided, which is 71.7% of site area (after lot line adjustment). Parking area landscaping is provided at greater than 10% of the new parking area. Dense plantings, with a variety of predominantly native species, provide effective stormwater management in rain gardens. These requirements are satisfied.

(.04) Buffering and Screening. Additional to the standards of this subsection, the requirements of the Section 4.137.5 (Screening and Buffering Overlay Zone) shall also be applied, where applicable.

- A. *All intensive or higher density developments shall be screened and buffered from less intense or lower density developments.*
- B. *Activity areas on commercial and industrial sites shall be buffered and screened from adjacent residential areas. Multi-family developments shall be screened and buffered from single-family areas.*
- C. *All exterior, roof and ground mounted, mechanical and utility equipment shall be screened from ground level off-site view from adjacent streets or properties.*
- D. *All outdoor storage areas shall be screened from public view, unless visible storage has been approved for the site by the Development Review Board or Planning Director acting on a development permit.*
- E. *In all cases other than for industrial uses in industrial zones, landscaping shall be designed to screen loading areas and docks, and truck parking.*
- F. *In any zone any fence over six (6) feet high measured from soil surface at the outside of fenceline shall require Development Review Board approval.*

Response: The proposed parking area is not visible from the right-of-way, and the adjacent properties are zone PDI and FDAHI, and are under same use as the Subject Site. The portion of the Subject Site where development is proposed is over 250' from the nearest road (SW 5th Street). No new exterior, roof, and/or ground mounted mechanical and utility equipment is proposed. No outdoor storage is proposed. No fence over 6' in height is proposed. This standard is satisfied.

(.05) Sight-Obscuring Fence or Planting. The use for which a sight-obscuring fence or planting is required shall not begin operation until the fence or planting is erected or in place and approved by the City. A temporary occupancy permit may be issued upon a posting of a bond or other security equal to one hundred ten percent (110%) of the cost of such fence or planting and its installation. (See Sections 4.400 to 4.470 for additional requirements.)

Response: The proposed parking area is not visible from the right-of-way, and the adjacent properties are zoned PDI and FDAHI. The proposed development does not require sight-obscuring fencing or plantings for the anticipated parking area to support manufacturing and warehousing uses. This provision is not applicable to this proposal; however, should a future development propose to conduct an activity for which such fencing would be required, they will have to obtain approval for an appropriate screening plan before proceeding.

(.06) *Plant Materials.*

A. *Shrubs and Ground Cover. All required ground cover plants and shrubs must be of sufficient size and number to meet these standards within three (3) years of planting. Non-horticultural plastic sheeting or other impermeable surface shall not be placed under mulch. Native topsoil shall be preserved and reused to the extent feasible. Surface mulch or bark dust are to be fully raked into soil of appropriate depth, sufficient to control erosion, and are confined to areas around plantings. Areas exhibiting only surface mulch, compost or barkdust are not to be used as substitutes for plant areas.*

1. *Shrubs. All shrubs shall be well branched and typical of their type as described in current AAN Standards and shall be equal to or better than 2-gallon containers and 10" to 12" spread.*
2. *Ground cover. Shall be equal to or better than the following depending on the type of plant materials used: gallon containers spaced at 4 feet on center minimum, 4" pot spaced 2 feet on center minimum, 2-1/4" pots spaced at 18 inch on center minimum. No bare root planting shall be permitted. Ground cover shall be sufficient to cover at least 80% of the bare soil in required landscape areas within three (3) years of planting. Where wildflower seeds are designated for use as a ground cover, the City may require annual re-seeding as necessary.*
3. *Turf or lawn in non-residential developments. Shall not be used to cover more than ten percent (10%) of the landscaped area, unless specifically approved based on a finding that, due to site conditions and availability of water, a larger percentage of turf or lawn area is appropriate. Use of lawn fertilizer shall be discouraged. Irrigation drainage runoff from lawns shall be retained within lawn areas.*
4. *Plant materials under trees or large shrubs. Appropriate plant materials shall be installed beneath the canopies of trees and large shrubs to avoid the appearance of bare ground in those locations.*
5. *Integrate compost-amended topsoil in all areas to be landscaped, including lawns, to help detain runoff, reduce irrigation and fertilizer needs, and create a sustainable, low-maintenance landscape.*

Response: Detailed instructions for landscape plants, materials and installation are provided in the Landscaping Plan (L-series sheets in Exhibit E). The specifications have been prepared in compliance with these and other City of Wilsonville requirements.

B. *Trees. All trees shall be well-branched and typical of their type as described in current American Association of Nurserymen (AAN) Standards and shall be balled and burlapped. The trees shall be grouped as follows:*

1. *Primary trees which define, outline or enclose major spaces, such as Oak, Maple, Linden, and Seedless Ash, shall be a minimum of 2" caliper.*
2. *Secondary trees which define, outline or enclose interior areas, such as Columnar Red Maple, Flowering Pear, Flame Ash, and Honeylocust, shall be a minimum of 1-3/4" to 2" caliper.*

3. *Accent trees which, are used to add color, variation and accent to architectural features, such as Flowering Pear and Kousa Dogwood, shall be 1-3/4" minimum caliper.*
4. *Large conifer trees such as Douglas Fir or Deodar Cedar shall be installed at a minimum height of eight (8) feet.*
5. *Medium-sized conifers such as Shore Pine, Western Red Cedar or Mountain Hemlock shall be installed at a minimum height of five to six (5 to 6) feet.*

Response: Detailed specifications for landscape plants, materials, and installation are provided in the Landscaping Plan (Exhibit E). The specifications have been prepared in compliance with these requirements.

C. *Where a proposed development includes buildings larger than twenty-four (24) feet in height or greater than 50,000 square feet in footprint area, the Planning Director or the Development Review Board, as applicable, may require larger or more mature plant materials:*

1. *At maturity, proposed trees shall be at least one-half the height of the building to which they are closest, and building walls longer than 50 feet shall require tree groups located no more than fifty (50) feet on center, to break up the length and height of the façade.*
2. *Either fully branched deciduous or evergreen trees may be specified depending upon the desired results. Where solar access is to be preserved, only solar-friendly deciduous trees are to be used. Where year-round sight obscuring is the highest priority, evergreen trees are to be used.*
3. *The following standards are to be applied:*
 - a. *Deciduous trees:*
 - i. *Minimum height of ten (10) feet; and*
 - ii. *Minimum trunk diameter (caliper) of 2 inches (measured at four and one-half [4 1/2] feet above grade).*
 - b. *Evergreen trees: Minimum height of twelve (12) feet.*

Response: Detailed specifications for landscape plants, materials, and installation are provided in the Landscaping Plan (Exhibit E). The specifications have been prepared in compliance with these requirements.

D. *Street Trees. In order to provide a diversity of species, the Development Review Board may require a mix of street trees throughout a development. Unless the Board waives the requirement for reasons supported by a finding in the record, different types of street trees shall be required for adjoining blocks in a development.*

1. *All trees shall be standard base grafted, well branched and typical of their type as described in current AAN Standards and shall be balled and burlapped (b&b). Street trees shall be planted at sizes in accordance with the following standards:*
 - a. *Arterial streets - 3" minimum caliper*
 - b. *Collector streets - 2" minimum caliper.*
 - c. *Local streets or residential private access drives - 1-3/4" minimum caliper.*
 - d. *Accent or median tree -1-3/4" minimum caliper.*
2. *The following trees and varieties thereof are considered satisfactory street trees in most circumstances; however, other varieties and species are encouraged and will be considered:*
 - a. *Trees over 50 feet mature height: Quercus garryana (Native Oregon White Oak), Quercus rubra borealis (Red Oak), Acer Macrophyllum (Native Big Leaf Maple), Acer nigrum (Green Column Black Maple), Fraxinus*

americanus (White Ash), Fraxinus pennsylvannica 'Marshall' (Marshall Seedless Green Ash), Quercus coccinea (Scarlet Oak), Quercus pulustris (Pin Oak), Tilia americana (American Linden).

- b. Trees under 50 feet mature height: Acer rubrum (Red Sunset Maple), Cornus nuttallii (NativePacific Dogwood), Gleditsia triacanthos (Honey Locust), Pyrus calleryana 'Bradford' (Bradford Pear), Tilia cordata (Little Leaf Linden), Fraxinus oxycarpa (Flame Ash).*
- c. Other street tree species. Other species may be specified for use in certain situations. For instance, evergreen species may be specified where year-round color is desirable and no adverse effect on solar access is anticipated. Water-loving species may be specified in low locations where wet soil conditions are anticipated.*

Response: No new street trees are proposed or warranted as part of the proposed development. This standard is not applicable.

E. Types of Plant Species.

- 1. Existing landscaping or native vegetation may be used to meet these standards, if protected and maintained during the construction phase of the development and if the plant species do not include any that have been listed by the City as prohibited. The existing native and non-native vegetation to be incorporated into the landscaping shall be identified.*
- 2. Selection of plant materials. Landscape materials shall be selected and sited to produce hardy and drought-tolerant landscaping. Selection shall be based on soil characteristics, maintenance requirements, exposure to sun and wind, slope and contours of the site, and compatibility with other vegetation that will remain on the site. Suggested species lists for street trees, shrubs and groundcovers shall be provided by the City of Wilsonville.*
- 3. Prohibited plant materials. The City may establish a list of plants that are prohibited in landscaped areas. Plants may be prohibited because they are potentially damaging to sidewalks, roads, underground utilities, drainage improvements, or foundations, or because they are known to be invasive to native vegetation.*

Response: Detailed specifications for landscape plants, materials, and installation are provided in the Landscaping Plan (Exhibit E). The specifications have been prepared in compliance with these requirements.

F. Tree Credit.

Existing trees that are in good health as certified by an arborist and are not disturbed during construction may count for landscaping tree credit as follows (measured at four and one-half feet above grade and rounded to the nearest inch):

<i>Existing trunk diameter</i>	<i>Number of Tree Credits</i>
<i>18 to 24 inches in diameter</i>	<i>3 tree credits</i>
<i>25 to 31 inches in diameter</i>	<i>4 tree credits</i>
<i>32 inches or greater</i>	<i>5 tree credits</i>

- 1. It shall be the responsibility of the owner to use reasonable care to maintain preserved trees. Trees preserved under this section may only be removed if an application for removal permit under Section 4.610.10(01)(H) has been approved. Required mitigation for removal shall be replacement with the number of trees credited to the preserved and removed tree.*

2. *Within five years of occupancy and upon notice from the City, the property owner shall replace any preserved tree that cannot be maintained due to disease or damage, or hazard or nuisance as defined in Chapter 6 of this code. The notice shall be based on complete information provided by an arborist. Replacement with the number of trees credited shall occur within one (1) growing season of notice.*
- G. *Exceeding Standards. Landscape materials that exceed the minimum standards of this Section are encouraged, provided that height and vision clearance requirements are met.*
- H. *Compliance with Standards. The burden of proof is on the applicant to show that proposed landscaping materials will comply with the purposes and standards of this Section.*

Response: The applicant does not seek credit for the existing trees as part of this consolidated application request.

(.07) Installation and Maintenance.

- A. *Installation. Plant materials shall be installed to current industry standards and shall be properly staked to assure survival. Support devices (guy wires, etc.) shall not be allowed to interfere with normal pedestrian or vehicular movement.*
- B. *Maintenance. Maintenance of landscaped areas is the on-going responsibility of the property owner. Any landscaping installed to meet the requirements of this Code, or any condition of approval established by a City decision-making body acting on an application, shall be continuously maintained in a healthy, vital and acceptable manner. Plants that die are to be replaced in kind, within one growing season, unless appropriate substitute species are approved by the City. Failure to maintain landscaping as required in this Section shall constitute a violation of this Code for which appropriate legal remedies, including the revocation of any applicable land development permits, may result.*
- C. *Irrigation. The intent of this standard is to assure that plants will survive the critical establishment period when they are most vulnerable due to a lack of watering and also to assure that water is not wasted through unnecessary or inefficient irrigation. Approved irrigation system plans shall specify one of the following:*
 1. *A permanent, built-in, irrigation system with an automatic controller. Either a spray or drip irrigation system, or a combination of the two, may be specified.*
 2. *A permanent or temporary system designed by a landscape architect licensed to practice in the State of Oregon, sufficient to assure that the plants will become established and drought-tolerant.*
 3. *Other irrigation system specified by a licensed professional in the field of landscape architecture or irrigation system design.*
 4. *A temporary permit issued for a period of one year, after which an inspection shall be conducted to assure that the plants have become established. Any plants that have died, or that appear to the Planning Director to not be thriving, shall be appropriately replaced within one growing season. An inspection fee and a maintenance bond or other security sufficient to cover all costs of replacing the plant materials shall be provided, to the satisfaction of the Community Development Director. Additionally, the applicant shall provide the City with a written license or easement to enter the property and cause any failing plant materials to be replaced.*
- D. *Protection. All required landscape areas, including all trees and shrubs, shall be protected from potential damage by conflicting uses or activities including vehicle parking and the storage of materials.*

Response: The landscaping plan (Exhibit E) demonstrates the feasibility of installing landscape materials in compliance with these requirements. Compliance can be assured through imposition of a condition of approval.

(.08) Landscaping on Corner Lots. All landscaping on corner lots shall meet the vision clearance standards of Section 4.177. If high screening would ordinarily be required by this Code, low screening shall be substituted within vision clearance areas. Taller screening may be required outside of the vision clearance area to mitigate for the reduced height within it.

Response: This standard is not applicable as this site is not a corner lot.

(.09) Landscape Plans. Landscape plans shall be submitted showing all existing and proposed landscape areas. Plans must be drawn to scale and show the type, installation size, number and placement of materials. Plans shall include a plant material list. Plants are to be identified by both their scientific and common names. The condition of any existing plants and the proposed method of irrigation are also to be indicated. Landscape plans shall divide all landscape areas into the following categories based on projected water consumption for irrigation:

- A. High water usage areas (+/- two (2) inches per week): small convoluted lawns, lawns under existing trees, annual and perennial flower beds, and temperamental shrubs;*
- B. Moderate water usage areas (+/- one (1) inch per week): large lawn areas, average water-using shrubs, and trees;*
- C. Low water usage areas (Less than one (1) inch per week, or gallons per hour): seeded fieldgrass, swales, native plantings, drought-tolerant shrubs, and ornamental grasses or drip irrigated areas.*
- D. Interim or unique water usage areas: areas with temporary seeding, aquatic plants, erosion control areas, areas with temporary irrigation systems, and areas with special water-saving features or water harvesting irrigation capabilities.*

These categories shall be noted in general on the plan and on the plant material list.

Response: As indicated in the planting plan, all landscape areas of the site fall into category C, Low water usage areas (see in Exhibit E, Sheet L0.01, a Zoning Compliance Note for Section 4.176(.09) Water Usage). The proposed plant palette is native and drought tolerant once established.

(.10) Completion of Landscaping. The installation of plant materials may be deferred for a period of time specified by the Board or Planning Director acting on an application, in order to avoid hot summer or cold winter periods, or in response to water shortages.

In these cases, a temporary permit shall be issued, following the same procedures specified in subsection (.07)(C)(3), above, regarding temporary irrigation systems. No final Certificate of Occupancy shall be granted until an adequate bond or other security is posted for the completion of the landscaping, and the City is given written authorization to enter the property and install the required landscaping, in the event that the required landscaping has not been installed. The form of such written authorization shall be submitted to the City Attorney for review.

Response: This application does not request deferral of plant material installation; however, depending on the seasonality of construction, the applicant may work with City staff to utilize these provisions to plant at the appropriate time(s), as allowed under this provision.

(.11) Street Trees Not Typically Part of Site Landscaping. Street trees are not subject to the requirements of this Section and are not counted toward the required standards of this Section. Except, however, that the Development Review Board may, by granting a waiver or variance, allow for special landscaping within the right-of-way to compensate for a lack of appropriate on-site locations for landscaping. See subsection (.06), above, regarding street trees.

Response: The applicant does not request that street trees be counted as part of the site landscaping. This standard is not applicable.

(.12) Mitigation and Restoration Plantings. A mitigation plan is to be approved by the City's Development Review Board before the destruction, damage, or removal of any existing native plants. Plantings intended to mitigate the loss of native vegetation are subject to the following standards. Where these standards conflict with other requirements of this Code, the standards of this Section shall take precedence. The desired effect of this section is to preserve existing native vegetation.

- A. Plant Sources. Plant materials are to be native and are subject to approval by the City. They are to be non-clonal in origin; seed source is to be as local as possible, and plants must be nursery propagated or taken from a pre-approved transplantation area. All of these requirements are to be addressed in any proposed mitigation plan.*
- B. Plant Materials. The mitigation plan shall specify the types and installation sizes of plant materials to be used for restoration. Practices such as the use of pesticides, fungicides, and fertilizers shall not be employed in mitigation areas unless specifically authorized and approved.*
- C. Installation. Install native plants in suitable soil conditions. Plant materials are to be supported only when necessary because of extreme winds at the site. Where support is necessary, all stakes, guy wires or other measures are to be removed as soon as the plants can support themselves. Protect from animal and fowl predation and foraging until establishment.*
- D. Irrigation. Permanent irrigation systems are generally not appropriate in restoration situations, and manual or temporary watering of new plantings is often necessary. The mitigation plan shall specify the method and frequency of manual watering, including any that may be necessary after the first growing season.*
- E. Monitoring and Reporting. Monitoring of native landscape areas is the on-going responsibility of the property owner. Plants that die are to be replaced in kind and quantity within one year. Written proof of the survival of all plants shall be required to be submitted to the City's Planning Department one year after the planting is completed.*

Response: The applicant has included in this request a Type C Tree Removal request for review and approval because the proposed site improvements to support the existing industrial development of the property cannot be achieved without removal of seven (7) existing trees.

Section 4.177. Street Improvement Standards

This section contains the City's requirements and standards for pedestrian, bicycle, and transit facility improvements to public streets, or within public easements. The purpose of this section is to ensure that development, including redevelopment, provides transportation facilities that are safe, convenient, and adequate in rough proportion to their impacts.

(.01) Development and related public facility improvements shall comply with the standards in this section, the Wilsonville Public Works Standards, and the Transportation System Plan, in rough proportion to the potential impacts of the development. Such improvements shall be constructed at the time of development or as provided by Section 4.140, except as modified or waived by the City Engineer for reasons of safety or traffic operations.

Response: The subject site has frontage on SW 5th Street. Per Staff's notes from the Pre-Application Conference, SW 5th Street (after the current construction completion) is fully improved and no street improvements and/or dedication is required.

(.02) Street Design Standards.

- A. All street improvements and intersections shall provide for the continuation of streets through specific developments to adjoining properties or subdivisions.*
 - 1. Development shall be required to provide existing or future connections to adjacent sites through the use of access easements where applicable. Such*

easements shall be required in addition to required public street dedications as required in Section 4.236(.04).

Response: The subject site has frontage on SW 5th Street. Per Staff's notes from the Pre-Application Conference, SW 5th Street (after the current construction completion) is fully improved and no street improvements and/or dedication is required.

B. The City Engineer shall make the final determination regarding right-of-way and street element widths using the ranges provided in Chapter 3 of the Transportation System Plan and the additional street design standards in the Public Works Standards.

Response: The subject site has frontage on SW 5th Street. Per Staff's notes from the Pre-Application Conference, SW 5th Street (after the current construction completion) is fully improved and no street improvements and/or dedication is required.

C. Rights-of-way.

- 1. Prior to issuance of a Certificate of Occupancy Building permits or as a part of the recordation of a final plat, the City shall require dedication of rights-of-way in accordance with the Transportation System Plan. All dedications shall be recorded with the County Assessor's Office.*
- 2. The City shall also require a waiver of remonstrance against formation of a local improvement district, and all non-remonstrances shall be recorded in the County Recorder's Office as well as the City's Lien Docket, prior to issuance of a Certificate of Occupancy Building Permit or as a part of the recordation of a final plat.*
- 3. In order to allow for potential future widening, a special setback requirement shall be maintained adjacent to all arterial streets. The minimum setback shall be 55 feet from the centerline or 25 feet from the right-of-way designated on the Master Plan, whichever is greater.*

Response: The subject site has frontage on SW 5th Street. Per Staff's notes from the Pre-Application Conference, SW 5th Street (after the current construction completion) is fully improved and no street improvements and/or dedication is required.

D. Dead-end Streets. New dead-end streets or cul-de-sacs shall not exceed 200 feet in length, unless the adjoining land contains barriers such as existing buildings, railroads or freeways, or environmental constraints such as steep slopes, or major streams or rivers, that prevent future street extension and connection. A central landscaped island with rainwater management and infiltration are encouraged in cul-de-sac design. No more than 25 dwelling units shall take access to a new dead-end or cul-de-sac street unless it is determined that the traffic impacts on adjacent streets will not exceed those from a development of 25 or fewer units. All other dimensional standards of dead-end streets shall be governed by the Public Works Standards. Notification that the street is planned for future extension shall be posted on the dead-end street.

Response: No new dead-end streets or cul-de-sac are proposed as part of this project. This standard does not apply.

E. Corner or clear vision area.

- 1. A clear vision area which meets the Public Works Standards shall be maintained on each corner of property at the intersection of any two streets, a street and a railroad or a street and a driveway. However, the following items shall be exempt from meeting this requirement:*
 - a. Light and utility poles with a diameter less than 12 inches.*

- b. *Trees less than 6" d.b.h., approved as a part of the Stage II Site Design, or administrative review.*
- c. *Except as allowed by b., above, an existing tree, trimmed to the trunk, 10 feet above the curb.*
- d. *Official warning or street sign.*
- e. *Natural contours where the natural elevations are such that there can be no cross-visibility at the intersection and necessary excavation would result in an unreasonable hardship on the property owner or deteriorate the quality of the site.*

Response: Landscape plantings at the proposed driveway are designed to provide adequate visibility in both directions for safe operations. Landscape maintenance practices will ensure visibility on an ongoing basis. This standard is met.

- F. *Vertical clearance - a minimum clearance of 12 feet above the pavement surface shall be maintained over all streets and access drives.*

Response: As illustrated on the L-series sheets in Exhibit E, no structural elements are proposed over streets and drives. This standard is met.

- G. *Interim improvement standard. It is anticipated that all existing streets, except those in new subdivisions, will require complete reconstruction to support urban level traffic volumes. However, in most cases, existing and short-term projected traffic volumes do not warrant improvements to full Master Plan standards. Therefore, unless otherwise specified by the Development Review Board, the following interim standards shall apply.*

1. *Arterials - 24 foot paved, with standard sub-base. Asphalt overlays are generally considered unacceptable, but may be considered as an interim improvement based on the recommendations of the City Engineer, regarding adequate structural quality to support an overlay.*
2. *Half-streets are generally considered unacceptable. However, where the Development Review Board finds it essential to allow for reasonable development, a half-street may be approved. Whenever a half-street improvement is approved, it shall conform to the requirements in the Public Works Standards:*
3. *When considered appropriate in conjunction with other anticipated or scheduled street improvements, the City Engineer may approve street improvements with a single asphalt lift. However, adequate provision must be made for interim storm drainage, pavement transitions at seams and the scheduling of the second lift through the Capital Improvements Plan.*

[Amended by Ord. 610, 5/1/06]

Response: The subject site has frontage on SW 5th Street. Per Staff's notes from the Pre-Application Conference, SW 5th Street (after the current construction completion) is fully improved and no street improvements and/or dedication is required.

(.03) Sidewalks. Sidewalks shall be provided on the public street frontage of all development. Sidewalks shall generally be constructed within the dedicated public right-of-way, but may be located outside of the right-of-way within a public easement with the approval of the City Engineer.

- A. *Sidewalk widths shall include a minimum through zone of at least five feet. The through zone may be reduced pursuant to variance procedures in Section 4.196, a waiver pursuant to Section 4.118, or by authority of the City Engineer for reasons of traffic operations, efficiency, or safety.*
- B. *Within a Planned Development, the Development Review Board may approve a sidewalk on only one side. If the sidewalk is permitted on just one side of the street, the owners will*

be required to sign an agreement to an assessment in the future to construct the other sidewalk if the City Council decides it is necessary.

Response: The subject site has frontage on SW 5th Street. Per Staff's notes from the Pre-Application Conference, SW 5th Street (after the current construction completion) is fully improved and no street improvements and/or dedication is required.

(.04) Bicycle Facilities. Bicycle facilities shall be provided to implement the Transportation System Plan, and may include on-street and off-street bike lanes, shared lanes, bike boulevards, and cycle tracks. The design of on-street bicycle facilities will vary according to the functional classification and the average daily traffic of the facility.

Response: The subject site has frontage on SW 5th Street. Per Staff's notes from the Pre-Application Conference, SW 5th Street (after the current construction completion) is fully improved and no street improvements and/or dedication is required.

(.05) Multiuse Pathways. Pathways may be in addition to, or in lieu of, a public street. Paths that are in addition to a public street shall generally run parallel to that street, and shall be designed in accordance with the Public Works Standards or as specified by the City Engineer. Paths that are in lieu of a public street shall be considered in areas only where no other public street connection options are feasible, and are subject to the following standards.

- A. *Paths shall be located to provide a reasonably direct connection between likely pedestrian and bicyclist destinations. Additional standards relating to entry points, maximum length, visibility, and path lighting are provided in the Public Works Standards.*
- B. *To ensure ongoing access to and maintenance of pedestrian/bicycle paths, the City Engineer will require dedication of the path to the public and acceptance of the path by the City as public right-of-way; or creation of a public access easement over the path.*

Response: The subject site has frontage on SW 5th Street. Per Staff's notes from the Pre-Application Conference, SW 5th Street (after the current construction completion) is fully improved and no street improvements and/or dedication is required.

(.06) Transit Improvements

Development on sites that are adjacent to or incorporate major transit streets shall provide improvements as described in this section to any bus stop located along the site's frontage, unless waived by the City Engineer for reasons of safety or traffic operations. Transit facilities include bus stops, shelters, and related facilities. Required transit facility improvements may include the dedication of land or the provision of a public easement.

- A. *Development shall at a minimum provide:*
 - 1. *Reasonably direct pedestrian connections, as defined by Section 4.154, between building entrances and the transit facility and between buildings on the site and streets adjoining transit stops.*
 - 2. *Improvements at major transit stops. Improvements may include intersection or mid-block traffic management improvements to allow for pedestrian crossings at major transit stops.*
- B. *Developments generating an average of 49 or more pm peak hour trips shall provide bus stop improvements per the Public Works Standards. Required improvements may include provision of benches, shelters, pedestrian lighting; or provision of an easement or dedication of land for transit facilities.*
- C. *In addition to the requirements of 4.177(.06)(A.)(2.), development generating more than 199 pm peak hour trips on major transit streets shall provide a bus pullout, curb extension,*

and intersection or mid-block traffic management improvements to allow for pedestrian crossings at major transit stops.

- D. *In addition to the requirements of 4.177(.06)(A.) and (B.), development generating more than 500 pm peak-hour trips on major transit streets shall provide on-site circulation to accommodate transit service*

Response: These provisions are not applicable because the proposed development is not adjacent to a major transit facility.

(.07) Residential Private Access Drives. Residential Private Access Drives shall meet the following standards:

- A. *Residential Private Access Drives shall provide primary vehicular access to no more than four (4) dwelling units, excluding accessory dwelling units.*
- B. *The design and construction of a Residential Private Access Drive shall ensure a useful lifespan and structural maintenance schedule comparable, as determined by the City Engineer or City's Authorized Representative, to a local street constructed in conformance to current public works standards.*
 - 1. *The design of residential private access drives shall be stamped by a professional engineer registered in the state of Oregon and shall be approved by the City Engineer or City's Authorized Representative to ensure the above requirement is met.*
 - 2. *Prior to issuing a certificate of occupancy for any residential dwelling unit whose primary vehicular access is from a Residential Private Access Drive the City Engineer or City's Authorized Representative shall certify construction of the Residential Private Access Drive substantially conforms the design approved by the City Engineer or City's Authorized Representative.*
- C. *Residential Private Access Drives shall be named for addressing purposes. All Residential Private Access Drives shall use the suffix "Lane", i.e. SW Oakview Lane.*
- D. *Residential Private Access Drives shall meet or exceed the standards for access drives and travel lanes established in Subsection (.08) of this Section.*

Response: The proposed development is industrial, not residential. This standard does not apply.

(.08). Access Drive and Driveway Approach Development Standards.

- A. *An access drive to any proposed development shall be designed to provide a clear travel lane free from any obstructions.*

Response: The proposed driveway will utilize an existing driveway approach from SW 5th Street at the southeast corner of the property. The proposed driveway access has been designed to allow safe turning movements to and from the site, and to minimize conflicting movements within the site as well.

- B. *Access drive travel lanes shall be constructed with a hard surface capable of carrying a 23-ton load.*
- C. *Where emergency vehicle access is required, approaches and driveways shall be designed and constructed to accommodate emergency vehicle apparatus and shall conform to applicable fire protection requirements. The City may restrict parking, require signage, or require other public safety improvements pursuant to the recommendations of an emergency service provider.*
- D. *Secondary or emergency access lanes may be improved to a minimum 12 feet with an all-weather surface as approved by the Fire District. All fire lanes shall be dedicated easements.*

Response: The proposed site plan demonstrates the feasibility to comply with these emergency access requirements. Detailed specifications will be included in plans submitted for site construction. This standard is met.

E. Minimum access requirements shall be adjusted commensurate with the intended function of the site based on vehicle types and traffic generation.

Response: The new driveway, including proposed driveway widths, is appropriate to accommodate the anticipated truck traffic at this site based on its intended use for manufacturing and warehousing activities. The proposed driveway will reduce the demand for both passenger vehicles and trucks to share the existing, single access at the northwest corner of the site (SW OrePac Avenue).

F. The number of approaches on higher classification streets (e.g., collector and arterial streets) shall be minimized; where practicable, access shall be taken first from a lower classification street.

Response: The proposed driveway will utilize an existing driveway approach from SW 5th Street (Collector classification) at the southeast corner of the property. The proposed driveway access has been designed to allow safe turning movements to and from the site, and to minimize conflicting movements within the site as well. This standard is met.

G. The City may limit the number or location of connections to a street, or impose access restrictions where the roadway authority requires mitigation to alleviate safety or traffic operations concerns.

Response: The proposed driveway will utilize an existing driveway approach from SW 5th Street (Collector classification) at the southeast corner of the property. The proposed driveway access has been designed to allow safe turning movements to and from the site, and to minimize conflicting movements within the site as well. Limitations on established access are not warranted.

H. The City may require a driveway to extend to one or more edges of a parcel and be designed to allow for future extension and inter-parcel circulation as adjacent properties develop. The City may also require the owner(s) of the subject site to record an access easement for future joint use of the approach and driveway as the adjacent property(ies) develop(s).

Response: The proposed driveway will utilize an existing driveway approach from SW 5th Street (Collector classification) at the southeast corner of the property. The proposed driveway access has been designed to allow safe turning movements to and from the site, and to minimize conflicting movements within the site as well. Interparcel circulation is not proposed due to the nature, and users, of the proposed driveway. The abutting parcel (tax lot 200) is served by an existing driveway; therefore, the imposition of a joint use of the driveway is not warranted. This standard is not applicable.

I. Driveways shall accommodate all projected vehicular traffic on-site without vehicles stacking or backing up onto a street.

J. Driveways shall be designed so that vehicle areas, including but not limited to drive-up and drive-through facilities and vehicle storage and service areas, do not obstruct any public right-of-way.

Response: The driveway and internal circulation are configured to allow exiting vehicles to queue as necessary within the site without congesting incoming vehicle movements. This provision is

satisfied. The site includes no drive-up, drive-through, or vehicle storage or service areas. These provisions are met.

- K. *Approaches and driveways shall not be wider than necessary to safely accommodate projected peak hour trips and turning movements, and shall be designed to minimize crossing distances for pedestrians.*

Response: The proposed driveway width has been based on movement patterns and turning radii associated with the anticipated mix of vehicles, to minimize potential for conflicting movements within the public right-of-way as well as the width of the existing driveway approach on SW 5th Street. These provisions are met.

- L. *As it deems necessary for pedestrian safety, the City, in consultation with the roadway authority, may require traffic-calming features, such as speed tables, textured driveway surfaces, curb extensions, signage or traffic control devices, or other features, be installed on or in the vicinity of a site.*

Response: No new trips are generated as a result of the proposed development. The driveway access to SW 5th Street was installed as part of the recent street improvement project.

- M. *Approaches and driveways shall be located and designed to allow for safe maneuvering in and around loading areas, while avoiding conflicts with pedestrians, parking, landscaping, and buildings.*

Response: The proposed driveway is located more than 600' from the nearest loading area. No pedestrian circulation is proposed along the alignment of the new driveway. The proposed driveway width is based on movement patterns and turning radii associated with the anticipated mix of vehicles, to minimize potential for conflicting movements within the public right-of-way as well as the width of the existing driveway approach on SW 5th Street. These provisions are met.

- N. *Where a proposed driveway crosses a culvert or drainage ditch, the City may require the developer to install a culvert extending under and beyond the edges of the driveway on both sides of it, pursuant applicable Public Works standards.*

Response: This provision is not applicable because this project will connect to an existing public storm drain system line within SW 5th Street. See Sheet C3 of Exhibit E. This standard is not applicable.

- O. *Except as otherwise required by the applicable roadway authority or waived by the City Engineer, temporary driveways providing access to a construction site or staging area shall be paved or graveled to prevent tracking of mud onto adjacent paved streets.*

Response: Following land use approval, the applicant will provide construction plans that comply with this requirement.

- P. *Unless constrained by topography, natural resources, rail lines, freeways, existing or planned or approved development, or easements or covenants, driveways proposed as part of a residential or mixed-use development shall meet local street spacing standards and shall be constructed to align with existing or planned streets, if the driveway.*

1. *Intersects with a public street that is controlled, or is to be controlled in the planning period, by a traffic signal;*
2. *Intersects with an existing or planned arterial or collector street; or*
3. *Would be an extension of an existing or planned local street, or of another major driveway.*

Response: This provision is not applicable because the proposed project is not a residential or mixed-use development.

(.09) *Minimum street intersection spacing standards.*

- A. *New streets shall intersect at existing street intersections so that centerlines are not offset. Where existing streets adjacent to a proposed development do not align properly, conditions shall be imposed on the development to provide for proper alignment.*
- B. *Minimum intersection spacing standards are provided in Transportation System Plan Table 3-2.*

Response: This provision is not applicable because no new street intersection is proposed as part of this project.

(.10) *Exceptions and Adjustments. The City may approve adjustments to the spacing standards of subsections (.08) and (.09) above through a Class II process, or as a waiver per Section 4.118(.03)(A.), where an existing connection to a City street does not meet the standards of the roadway authority, the proposed development moves in the direction of code compliance, and mitigation measures alleviate all traffic operations and safety concerns. Mitigation measures may include consolidated access (removal of one access), joint use driveways (more than one property uses same access), directional limitations (e.g.,*

Response: This provision is not applicable because subsections (.08) and (.09) are not applicable for the reasons stated above.

Section 4.179. Mixed Solid Waste and Recyclables Storage in New Multi-Unit Residential and Non-Residential Buildings

Response: No new residential or non-residential building area is being proposed as part of this application. This standard is not applicable.

Section 4.197 Zone Changes and Amendments to This Code – Procedures

(.01) *The following procedure shall be followed in applying for an amendment to the text of this Chapter: [detailed provisions omitted for brevity]*

Response: The applicant requests a zone map amendment, not a zone text amendment. This standard is not applicable.

(.02) *The following procedures shall be followed for zone map amendments.*

[Subsection A, applicable within Coffee Creek Industrial Design Overlay, omitted for brevity]

- B. *All other quasi-judicial zone map amendments shall be reviewed by the Development Review Board to make a recommendation to City Council and all legislative zone map amendments shall be reviewed by the Planning Commission to make a recommendation to City Council.*

Response: The Applicant requests a Zone Map Amendment of the Subject Property from FDAHI to PDI. The subject property is not located in the Coffee Creek Industrial Design Overlay District; therefore, the requested Zone Map Amendment requires the Development Review Board to make a recommendation to City Council. The evidence submitted herein, and exhibits to this application demonstrate the feasibility of the proposed Zone Map Amendment.

- C. *In recommending approval or denial of a proposed zone map amendment, the Planning Commission or Development Review Board shall at a minimum, adopt findings addressing the following criteria:*

- 1. *That the application before the Commission or Board was submitted in accordance with the procedures set forth in Section 4.008, Section 4.125 (.18)(B)(2) or, in the case of a Planned Development, Section 4.140; and*

Response: The applicant is requesting both Planned Development Stage I and Stage II approvals as part of this application. This Application has been submitted in accordance with the procedures set forth in Section 4.140. This standard is met.

2. *That the proposed amendment is consistent with the Comprehensive Plan map designation and substantially complies with the applicable goals, policies and objectives, set forth in the Comprehensive Plan text; and*

Response: The proposed Zone Map Amendment seeks to rezone the subject property from Future Development Agricultural Holding – Industrial (FDAHI) to Planned Development Industrial (PDI). The proposed Zone is consistent with the Comprehensive Plan map designation (Industrial), and complies with the Comprehensive Plan policies, as implemented by the City’s Development Code. Compliance with the Development Code is demonstrated by the evidence provided herein. This standard is met.

3. *In the event that the subject property, or any portion thereof, is designated as "Residential" on the City's Comprehensive Plan Map; specific findings shall be made addressing substantial compliance with Implementation Measures 4.1.4.b, d, e, q, and x of Wilsonville's Comprehensive Plan text; and*

Response: No portion of the subject property is designated as Residential on the City’s Comprehensive Plan Map. This standard is not applicable.

4. *That the existing primary public facilities, i.e., roads and sidewalks, water, sewer and storm sewer are available and are of adequate size to serve the proposed development; or, that adequate facilities can be provided in conjunction with project development. The Planning Commission and Development Review Board shall utilize any and all means to insure that all primary facilities are available and are adequately sized; and*

Response: As explained in the Applicant’s response to Section 4.177, SW 5th Street is fully improved, and per Staff’s comment (Exhibit I), no improvements to SW 5th Street are warranted. No new public water, sewer, or storm sewer facilities are proposed or warranted with this development. The applicant proposes a stormwater connection to the public stormwater main located in SW 5th Street.

5. *That the proposed development does not have a significant adverse effect upon Significant Resource Overlay Zone areas, an identified natural hazard, or an identified geologic hazard. When Significant Resource Overlay Zone areas or natural hazard, and/or geologic hazard are located on or abut the proposed development, the Planning Commission or Development Review Board shall use appropriate measures to mitigate and significantly reduce conflicts between the development and identified hazard or Significant Resource Overlay Zone; and*

Response: The subject properties does contain a Significant Resource Overlay Zone area located along the western boundary of the subject properties. As shown on Sheet C3 of Exhibit E, a vegetated stormwater facility is proposed within the SROZ Impact Area.

6. *That the applicant is committed to a development schedule demonstrating that development of the property is reasonably expected to commence within two years of the initial approval of the zone change; and*

Response: The proposed parking lot is already constructed, and the applicant seeks corrective action to legalize the parking lot. Improvements to the parking lot, as well as development of the new driveway will commence in a timely manner after approval of

the construction plans which will be submitted shortly after approval of the requested zone change.

7. *That the proposed development and use(s) can be developed in compliance with the applicable development standards or appropriate conditions are attached that insure that the project development substantially conforms to the applicable development standards; and*

Response: By the evidence presented in this narrative and supporting exhibits, the Applicant has demonstrated a feasible site development plan that complies with applicable development standards. The Applicant understands that appropriate conditions to ensure that the project development substantially conforms to the applicable development standards may be imposed.

8. *Adequate public facilities, services, and transportation networks are in place, or are planned to be provided concurrently with the development of the property. The applicant shall demonstrate compliance with the Transportation Planning Rule, specifically by addressing whether the proposed amendment has a significant effect on the transportation system pursuant to OAR 660-012-0060. A Traffic Impact Analysis (TIA) shall be prepared pursuant to the requirements in Section 4.133.05.(01).*

Response: A stormwater connection is proposed to the existing stormwater main in SW 5th Street as shown on Sheet C3 of Exhibit E. No new trip generation is anticipated as no new building area is proposed as part of this development.

- (.03) *If affirmative findings cannot be made for all applicable criteria listed above the proposed text or map amendment, as the case may be, shall be denied.*

Response: The applicant has provided affirmative findings to the criteria listed in 4.197.01.C, in addition to the evidence provided throughout this application and the supporting exhibits. The Applicant acknowledges the types of action which the review authority can take on this application.

- (.04) *City Council action approving a change in zoning shall be in the form of a Zoning Order.*

Response: This provision provides procedural guidance for implementation and requires no evidence within the applicant’s narrative.

- (.05) *In cases where a property owner or other applicant has requested a change in zoning and the City Council has approved the change subject to conditions, the owner or applicant shall sign a statement accepting, and agreeing to complete the conditions of approval before the zoning shall be changed.*

Response: The Applicant understands the authority of the City Council to impose conditions of approval, and that the Owner/Applicant will be required to sign a statement accepting and agreeing to complete the conditions of approval prior to the zone change.

Section 4.199 Outdoor Lighting

Section 4.199.10 Outdoor Lighting in General

- (.01) *Purpose.*

The purpose of this Code is to provide regulations for outdoor lighting that will:

- A. *Permit reasonable uses of outdoor lighting for nighttime safety, utility, security, productivity, enjoyment and commerce.*
- B. *Conserve energy and resources to the greatest extent possible.*

- C. *Minimize glare, particularly in and around public rights-of-way; and reduce visual discomfort and improve visual acuity over large areas by avoiding "light islands" and "spotlighting" that result in reduced visual perception in areas adjacent to either the source of the glare or the area illuminated by the glare.*
 - D. *Minimize light trespass, so that each owner of property does not cause unreasonable light spillover to other property.*
 - E. *Curtail the degradation of the nighttime environment and the night sky.*
 - F. *Preserve the dark night sky for astronomy and enjoyment.*
 - G. *Protect the natural environment, including wildlife, from the damaging effects of night lighting from human sources.*
- (.02) *Purpose Statement as Guidelines: Declaration of purpose statements are guidelines and not approval criteria in the application of WC Section 4.199.*

Section 4.199.20. *Applicability.*

- (.01) *This Ordinance is applicable to:*
- A. *Installation of new exterior lighting systems in public facility, commercial, industrial and multi-family housing projects with common areas.*
 - B. *Major additions or modifications (as defined in this Section) to existing exterior lighting systems in public facility, commercial, industrial and multi-family housing projects with common areas.*

Response: The proposed development is for lighting of a new parking lot; therefore, this section applies.

- (.02) *Exemption. The following luminaires and lighting systems are EXEMPT from these requirements:*
- A. *Interior lighting.*
 - B. *Internally illuminated signs.*
 - C. *Externally illuminated signs.*
 - D. *Temporary lighting for theatrical, television, and performance areas.*
 - E. *Lighting in swimming pools and other water features governed by Article 680 of the National Electrical Code.*
 - F. *Building Code required exit path lighting.*
 - G. *Lighting specifically for stairs and ramps.*
 - H. *Temporary and seasonal lighting provided that individual lamps are 10 watts or less.*
 - I. *Lighting required and/or regulated by the City (i.e. construction related activities), Federal Aviation Administration, U.S. Coast Guard or other Federal or State agency.*
 - J. *Single-family residential lighting.*
 - K. *Code Required Signs.*
 - L. *American flag.*
 - M. *Landscape lighting.*
 - N. *Lights approved by the City through an Administrative Review Temporary Use Permit process.*
 - O. *Public street lights.*
 - P. *ATM security lighting.*
 - Q. *Those "Exceptions" listed in the "Exterior Lighting Power Allowance" provisions of the Oregon Energy Efficiency Specialty Code.*

Response: The applicant is seeking approval of those lighting systems which do not fall into the exemptions listed above.

Section 4.199.30. Lighting Overlay Zones.

(.01) *The designated Lighting Zone as indicated on the Lighting Overlay Zone Map for a commercial, industrial, multi-family or public facility parcel or project shall determine the limitations for lighting systems and fixtures as specified in this Ordinance.*

- A. *Property may contain more than one lighting zone depending on site conditions and natural resource characteristics.*

Response: As illustrated in the City's Lighting Overlay Zone Map, this site and neighboring properties to the north, west, and south are in Lighting Zone LZ 2. Across the railroad tracks to the east, the area south of Bailey Street is in LZ2 and the area north of Bailey Street is in LZ3. The parking lot and site improvements are located at, or south of, an imaginary extension of Bailey Street.

(.02) *The Lighting Zones shall be:*

- A. *LZ 1. Developed areas in City and State parks, recreation areas, SROZ wetland and wildlife habitat areas; developed areas in natural settings; sensitive night environments; and rural areas. This zone is intended to be the default condition for rural areas within the City.*
- B. *LZ 2. Low-density suburban neighborhoods and suburban commercial districts, industrial parks and districts. This zone is intended to be the default condition for the majority of the City.*
- C. *LZ 3. Medium to high-density suburban neighborhoods and districts, major shopping and commercial districts as depicted on the Lighting Overlay Zone Map.*
- D. *LZ 4. Reserved for limited applications with special lighting requirements. This zone is appropriate for users who have unique site or operating circumstances that warrant additional light. This zone shall not be applied to residential or agricultural areas.*

[Section 4.199.30(.02) amended by Ord. 688, 11/15/10]

Response: Based on the descriptions above, this site is in Lighting Zone LZ 2 (as confirmed by the City's Lighting Overlay Zones map). A portion of the site is within an SROZ riparian corridor area, but no lighting is proposed in, or near, the SROZ area.

(.03) *Modification of Lighting Zones.*

- A. *The City Council may modify the designated Lighting Zones of one or more parcels if the City Council finds that the original Lighting Zone was in error, a change in circumstances has occurred warranting the change since the designation was established or the purposes of this section are better served.*
- B. *The Development Review Board (DRB) may modify the designated Lighting Zones as part of the Stage II, Site Design Review Process if the DRB finds that the original Lighting Zone was in error, or a change in circumstances has occurred warranting the change since the designation was established or the purposes of this section are better served.*
- C. *This ordinance establishes a Lighting Overlay Zone Map. The Planning Division shall maintain the current Lighting Overlay Zone Map.*

Response: The applicant is not seeking any modifications from the City's Lighting Overlay Zones map. This standard does not apply.

Section 4.199.40. Lighting Systems Standards for Approval.

(.01) *Non-Residential Uses and Common Residential Areas.*

- A. *All outdoor lighting shall comply with either the Prescriptive Option or the Performance Option below.*

Response: The applicant is utilizing the Performance Option for outdoor lighting.

- B. Prescriptive Option. If the lighting is to comply with this Prescriptive Option, the installed lighting shall meet all of the following requirements according to the designated Lighting Zone.*
- 1. The maximum luminaire lamp wattage and shielding shall comply with Table 7.*
 - 2. Except for those exemptions listed in Section 4.199.20(.02), the exterior lighting for the site shall comply with the Oregon Energy Efficiency Specialty Code, Exterior Lighting.*
 - 3. The maximum pole or mounting height shall be consistent with Table 8.*
 - 4. Each luminaire shall be set back from all property lines at least 3 times the mounting height of the luminaire:*
 - a. Exception 1: If the subject property abuts a property with the same base and lighting zone, no setback from the common lot lines is required.*
 - b. Exception 2: If the subject property abuts a property which is zoned (base and lighting) other than the subject parcel, the luminaire shall be setback three times the mounting height of the luminaire, measured from the abutting parcel's setback line. (Any variance or waiver to the abutting property's setback shall not be considered in the distance calculation).*
 - c. Exception 3: If the luminaire is used for the purpose of street, parking lot or public utility easement illumination and is located less than 3 mounting heights from the property line, the luminaire shall include a house side shield to protect adjoining property.*
 - d. Exception 4: If the subject property includes an exterior column, wall or abutment within 25 feet of the property line, a luminaire partly shielded or better and not exceeding 60 lamp watts may be mounted onto the exterior column, wall or abutment or under or within an overhang or canopy attached thereto.*
 - e. Exception 5: Lighting adjacent to SROZ areas shall be set back 3 times the mounting height of the luminaire, or shall employ a house side shield to protect the natural resource area.*

Response: The applicant is seeking approval of the parking area lighting plan using performance option. This standard is not applicable.

- C. Performance Option. If the lighting is to comply with the Performance Option, the proposed lighting design shall be submitted by the applicant for approval by the City meeting all of the following:*
- 1. The weighted average percentage of direct uplight lumens shall be less than the allowed amount per Table 9.*
 - 2. The maximum light level at any property line shall be less than the values in Table 9, as evidenced by a complete photometric analysis including horizontal illuminance of the site and vertical illuminance on the plane facing the site up to the mounting height of the luminaire mounted highest above grade. The Building Official or designee may accept a photometric test report, demonstration or sample, or other satisfactory confirmation that the luminaire meets the shielding requirements of Table 7. Luminaires shall not be mounted so as to permit aiming or use in any way other than the manner maintaining the shielding classification required herein:*
 - a. Exception 1. If the property line abuts a public right-of-way, including a sidewalk or street, the analysis may be performed across the street at the adjacent property line to the right-of-way.*

b. *Exception 2. If, in the opinion of the Building Official or designee, compliance is impractical due to unique site circumstances such as lot size or shape, topography, or size or shape of building, which are circumstances not typical of the general conditions of the surrounding area. The Building Official may impose conditions of approval to avoid light trespass to the maximum extent possible and minimize any additional negative impacts resulting to abutting and adjacent parcels, as well as public rights-of-way, based on best lighting practices and available lighting technology.*

3. *The maximum pole or mounting height shall comply with Table 8.*

Response: The applicant is utilizing the performance option. A photometric plan is included as Exhibit G and Lighting fixture details are included as Exhibit H. The enclosed photometric plan demonstrates the lighting in the area of the proposed southern parking area. The property lines are located well east, north, and south of the proposed southern parking area, to which there will be no spillover beyond the property lines. The proposed lighting fixtures (see Exhibit H) are fully shielded and do not generate upwards lighting. The pole height will be under 40' (maximum allowed within the LZ2) as evidenced by the details provided in Exhibit H. Further details, and a more detailed photometric plan will be provided at time of permit submittal. Additional compliance with this standard can be addressed through a condition of approval. This standard is met.

D. *Curfew. All prescriptive or performance based exterior lighting systems shall be controlled by automatic device(s) or system(s) that:*

1. *Initiate operation at dusk and either extinguish lighting one hour after close or at the curfew times according to Table 10; or*
2. *Reduce lighting intensity one hour after close or at the curfew time to not more than 50% of the requirements set forth in the Oregon Energy Efficiency Specialty Code unless waived by the DRB due to special circumstances; and*
3. *Extinguish or reduce lighting consistent with 1. and 2. above on Holidays.*

The following are exceptions to curfew:

- a. *Exception 1: Building Code required lighting.*
- b. *Exception 2: Lighting for pedestrian ramps, steps and stairs.*
- c. *Exception 3: Businesses that operate continuously or periodically after curfew.*

Response: It is feasible for the applicant to install an automatic device or system meeting these requirements; compliance can be assured through an appropriate condition of approval.

(.02) *Special Permit for Specific Lighting Fixtures and Systems and When Exceeding Lighting Requirements.*

- A. *This section is intended to apply to situations where more than normal foot candles are required due to a unique circumstance or use or where it is absolutely essential to perform the proposed activities after dark. All special permits shall be reviewed by the DRB.*
- B. *Upon issuance of a special permit by the Development Review Board (DRB), lighting systems not complying with the technical requirements of this Ordinance may be installed, maintained, and replaced for lighting that exceeds the maximums permitted by this Ordinance. This section is intended to be applied to uses such as sports lighting systems including but not limited to, sport fields and stadiums, such as baseball and football field lighting, tennis court lighting, swimming pool area lighting and prisons; other very intense lighting defined as having a light source exceeding 200,000 lumens or an intensity in any*

direction of more than 2,000,000 candelas; building façade lighting of portions of buildings over two stories high; and public monuments.

- C. *To obtain such a permit, applicants shall demonstrate that the proposed lighting installation:*
1. *Is within Lighting Zone 3 or above.*
 2. *Has been designed to minimize obtrusive light and artificial sky glow, supported by a signed statement from a registered civil or electrical engineer describing the mitigation measures. Such statement shall be accompanied by calculations indicating the light trespass levels (horizontal and vertical at ground level) at the property line.*
 3. *Will not create excessive glare, sky glow, or light trespass beyond that which can be reasonably expected by application of best lighting practices, and available technology.*
 4. *Provides appropriate lighting curfew hours based on the use and the surrounding areas.*
- D. *The DRB may impose conditions of approval to mitigate any negative impacts resulting to the abutting parcel, based on best lighting practices and available lighting technology.*
- E. *The City may charge a review fee and may, at the Building Official's option, employ the services of a qualified professional civil or electrical engineer to review such submittals and the cost thereof shall be an additional fee charged to the applicant.*

Response: The site does not appear to be eligible for a special lighting permit since it is located in Lighting Overlay Zone 2. The applicant is not seeking approval of a special permit for lighting. This standard does not apply.

Section 4.199.50. Submittal Requirements.

(.01) Applicants shall submit the following information as part of DRB review or administrative review of new commercial, industrial, multi-family or public facility projects:

- A. *A statement regarding which of the lighting methods will be utilized, prescriptive or performance, and a map depicting the lighting zone(s) for the property.*
- B. *A site lighting plan that clearly indicates intended lighting by type and location. For adjustable luminaires, the aiming angles or coordinates shall be shown.*
- C. *For each luminaire type, Drawings, cut sheets or other documents containing specifications for the intended lighting including but not limited to, luminaire description, mounting, mounting height, lamp type and manufacturer, lamp watts, ballast, optical system/distribution, and accessories such as shields.*
- D. *Calculations demonstrating compliance with Oregon Energy Efficiency Specialty Code, Exterior Lighting, as modified by Section 4.199.40(.01)(B.)(2.) [Amended by Ord. 688, 11/15/10]*
- E. *Lighting plans shall be coordinated with landscaping plans so that pole lights and trees are not placed in conflict with one another. The location of lights shall be shown on the landscape plan. Generally, pole lights should not be placed within one pole length of landscape and parking lot trees.*
- F. *Applicants shall identify the hours of lighting curfew.*

Response: As illustrated in the City's Lighting Overlay Zone Map, this site and neighboring properties to the north, west, and south are in Lighting Zone LZ 2. Across the railroad tracks to the east, the area south of Bailey Street is in LZ2 and the area north of Bailey Street is in LZ3. The parking lot and site improvements are located at, or south of, an imaginary extension of Bailey Street.

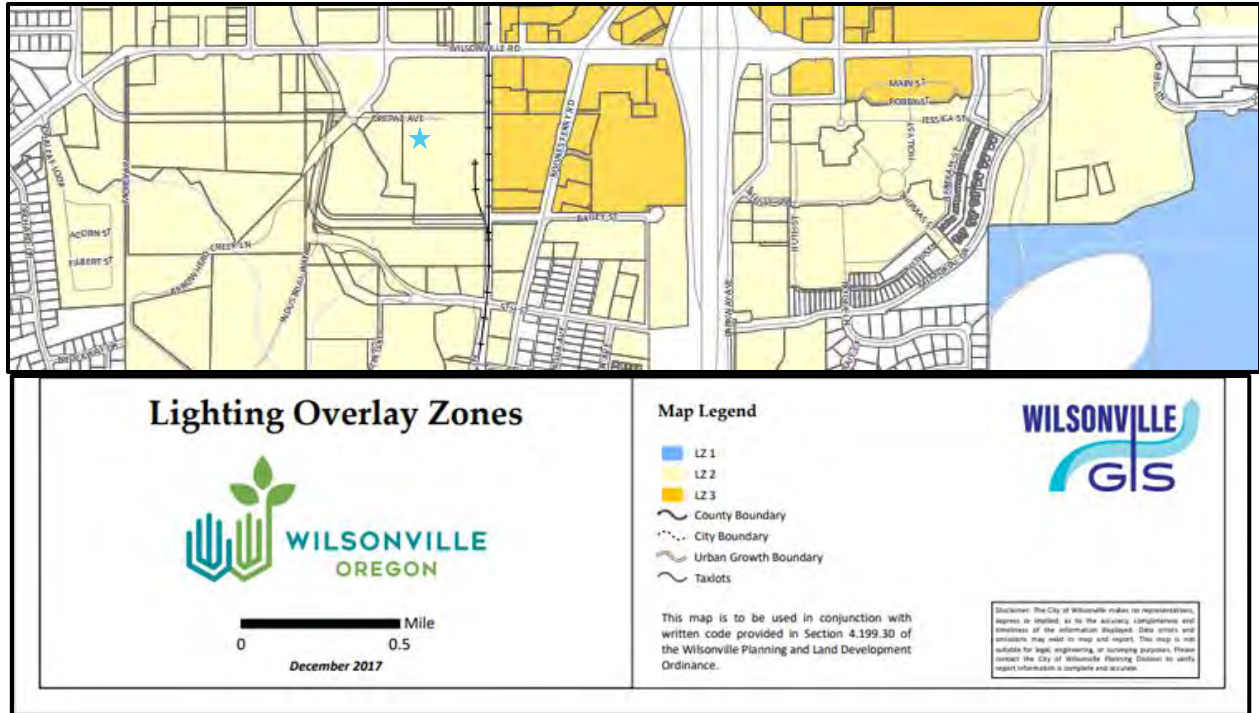

The lighting plan in Exhibits G and H show proposed locations for lighting fixtures and provides luminaire specifications (manufacturers’ data sheets for typical fixtures). Lighting locations have been coordinated with the landscape planting plan to avoid conflicts. In Lighting Overlay Zone 2, the lighting curfew time is 10:00 PM (2,200 hours).

The [OR Energy Code] for outdoor illumination establishes maximum energy use figures for building exterior areas, expressed in Watts per Square Foot (W/SF), with reference to Table 9.4.2 Individual Lighting Power Allowances for Building Exteriors [ANSI/ASHRAE/IES Standard 90.1-2022 (I-P)]. For buildings in Zones 1 through 4, those maximum energy consumption standards allow a range between 0.03 W/SF and 0.08 W/SF for Uncovered Parking Areas, and between 0.03 and 0.04 W/SF for Landscaping Areas.

The applicant’s exterior lighting plan includes the pole-mounted parking lot lighting.

Power Consumption of Proposed Lighting Fixtures

Shielded Fixture Type	Count	Input Watts/Unit	Total Watts	Watts/Area (25,000 SF parking)
Pole-Mounted Luminaire (Atlas SLP22270LED, 270-Watt LED Site Lighter Pro)	5 Luminaires on 5 Poles	270 W	1,350 W	0.054 W/SF
<i>Allowable Maximum Range (Zones 1 – 4)</i>				0.08 W/SF
Proposed Power Consumption as % of Lowest Allowable Maximum Per Code				68%

Based on this analysis, power consumption per unit area for the proposed development is 68% of the allowed power consumption rate per unit of area. This requirement is satisfied.

(.02) In addition to the above submittal requirements, Applicants using the Prescriptive Method shall submit the following information as part of the permit set plan review:

- A. *A site lighting plan (items 1 A - F, above) which indicates for each luminaire the 3 mounting height line to demonstrate compliance with the setback requirements. For luminaires mounted within 3 mounting heights of the property line the compliance exception or special shielding requirements shall be clearly indicated.*

Response: As illustrated in the City’s Lighting Overlay Zone Map, this site and neighboring properties to the north, west, and south are in Lighting Zone LZ 2. Across the railroad tracks to the east, the area south of Bailey Street is in LZ2 and the area north of Bailey Street is in LZ3. The parking lot and site improvements are located at, or south of, an imaginary extension of Bailey Street. The luminaires are well setback from the property lines as shown on Sheet C2 of Exhibit E. No exceptions are requested, and no special shielding requirements are warranted. This standard is met.

(.03) In addition to the above submittal requirements, Applicants using the Performance Method shall submit the following information as part of the permit set plan review:

- A. *Site plan showing horizontal isocandle lines, or the output of a point-by-point computer calculation of the horizontal illumination of the site, showing property lines and light levels immediately off of the subject property.*
- B. *For each side of the property, the output of a point-by-point vertical footcandle calculation showing illumination in the vertical plane at the property line from grade to at least 10 feet higher than the height of the tallest pole.*
- C. *Lighting plans shall be prepared by a qualified licensed engineer.*

Response: The applicant is utilizing the prescriptive option rather than the performance option. This standard does not apply.

(.04) In addition to the above applicable submittal requirements, Applicants for Special Permits shall submit the following to the DRB for review:

- A. *Tabulation of International Engineering Society of North America (IESNA) lighting recommendations for each task including area illuminated, recommended illumination level, actual maintained illumination level, and luminaires used specifically to achieve the indicated criteria.*
- B. *Lighting plans shall be prepared by a qualified licensed engineer.*

Response: The applicant is not seeking approval of a special permit for lighting. This standard does not apply.

(.05) For all calculations, the following light loss factors shall be used unless an alternative is specifically approved by the City:

Metal halide	0.6
High pressure sodium	0.8
Compact fluorescent	0.7
Full size fluorescent	0.75
Incandescent	0.9
Halogen	0.95
Other	As approved

Response: As shown in Exhibit H, LED site lighting is proposed. None of the above-mentioned lighting types are proposed. This standard is not applicable.

Section 4.199.60. Major Additions or Modifications to Pre-Existing Sites.

(01.) Major Additions. If a major addition occurs on a property, all of the luminaires on the site shall comply with the requirements of this Section. For purposes of this sub-section, the following are considered to be major additions:

- A. Additions of 50 percent or more in terms of additional dwelling units, gross floor area, seating capacity, or parking spaces, either with a single addition or with cumulative additions after July 2, 2008.
- B. Modification or replacement of 50 percent or more of the outdoor lighting luminaires' within a 5-year timeframe existing as of July 2, 2008.

Response: The applicant has submitted requests for a new development, not a major addition. This standard does not apply.

Table 7: Maximum Wattage And Required Shielding				
Lighting Zone	Fully Shielded	Shielded	Partly Shielded	Unshielded
LZ 1	70	20	13	Low voltage landscape lighting 50 watts or less
LZ 2	100	35	39	Low voltage landscape lighting 50 watts or less
LZ 3	250	100	70	Landscape and facade lighting 100 watts or less; ornamental lighting on private drives of 39 watts and less
LZ 4	450	150	150	Landscape and facade lighting 250 watts or less; ornamental lights on private drives and lanterns 70 watts or less; marquee lighting not employing medium based lamps

[Table 7 amended by Ord. 682, 9/9/10; Ord. 688, 11/15/10]

Lighting Zone	Lighting for private drives, driveways, parking, bus stops and other transit facilities	Lighting for walkways, bikeways, plazas and other pedestrian areas	All other lighting
LZ 0	20	8	4
LZ 1	25	12	4
LZ 2	40	18	8
LZ 3	40	18	16
LZ 4	<i>Height limit to be determined by Special Use Permit Only</i>		

Lighting mounted onto buildings or other structures shall not exceed a mounting height greater than 4 feet higher than the tallest part of the building or structure at the place where the lighting is installed, nor higher than 33.33 percent of the horizontal distance of the light from the nearest property line, whichever is less.

Lighting Zone	Maximum percentage of direct uplight lumens	Maximum Light Level at Property Line	
		Horizontal plane at grade (foot candles - fc)	Vertical plane facing the site in question, from grade to mounting height of highest mounted luminaire (foot candles – fc)
LZ 0	0	0.01 fc	0.02 fc
LZ 1	1%	0.05 fc	0.1 fc
LZ 2	5%	0.2 fc	0.4 fc
LZ 3	10%	0.4 fc	0.8 fc
LZ 4	20%	0.8 fc	1.6 fc

Lighting Zone	Curfew Time
LZ 0	8:00 PM (2000 hours)
LZ 1	
LZ 2	10:00 PM (2200 hours)
LZ 3	Midnight (2400 hours)
LZ 4	

[Tables, above, renumbered by Ord. 688, 11/15/10]

LAND DIVISIONS

Section 4.200. General Purpose

The City Council hereby finds and deems that it is reasonable and necessary, in order to accomplish the orderly development of land within the corporate limits of the City, and in order to promote the public health, safety and general welfare of the City, to enact these sections, to be hereinafter known as the "Land Division Regulations of the City of Wilsonville, Oregon," in order to provide rules, regulations and standards to govern the approval of plats for subdivisions, land partitions, condominium divisions, and plans for other property divisions, to carry out the development pattern and plan of the City and to promote the public health, safety and general welfare thereof, and in order to lessen congestion of streets, secure safety from fires, flood, pollution and other dangers and to provide adequate light and area, and to prevent overcrowding of land, improve connectivity from one part of the community to another, and to facilitate adequate provision for transportation, water supplies, sewage, drainage, education, recreation and other needs of the people of the City, and to prescribe procedures to be followed in submitting plans and plats of land divisions for approval by the City.

Section 4.202. General Authorization

- (.01) Pursuant to ORS Chapter 92, plans and plats must be approved by the Planning Director or Development Review Board (Board), as specified in Sections 4.030 and 4.031, before a plat for any land division may be filed in the county recording office for any land within the boundaries of the City, except that the Planning Director shall have authority to approve a final plat that is found to be substantially consistent with the tentative plat approved by the Board.*
- (.02) The Development Review Board and Planning Director shall be given all the powers and duties with respect to procedures and action on tentative and final plans, plats and maps of land divisions specified in Oregon Revised Statutes and by this Code.*
- (.03) Approval by the Development Review Board or Planning Director of divisions of land within the boundaries of the City, other than statutory subdivisions, is hereby required by virtue of the authority granted to the City in ORS 92.*
- (.04) No person shall sell any lot or parcel in any condominium, subdivision, or land partition until a final condominium, subdivision or partition plat has been approved by the Planning Director as set forth in this Code and properly recorded with the appropriate county.*
 - A. No development permit shall be issued for any lot or parcel that is not legally created in accordance with this Code.*
 - B. It shall be a violation of this Code to divide a tract of land into a parcel smaller than the lot size required in the Zoning Sections of this Code unless specifically approved by the Development Review Board or City Council. No conveyance of any portion of a lot, for other than a public use, shall leave a structure on the remainder of the lot with less than the minimum lot size, width, depth, frontage, yard or setback requirements, unless specifically authorized through the Variance procedures of Section 4.196 or the waiver provisions of the Planned Development procedures of Section 4.118.*
- (.05) Expedited land divisions and Middle Housing land divisions, pursuant to ORS 197, shall be processed as provided in Section 4.232.*
- (.06) New condominium developments shall be subject to the planned development procedures of Section 4.118 and the standards of Section 4.140.*
- (.07) Condominium conversions shall be subject to the standards and procedures applicable to land divisions, and the following.*

- A. Upon application, formal notice shall be provided to tenants on the land and to adjacent landowners within 250 feet of the affected property. Not less than 30 days after the formal notice, a public hearing as set forth in Section 4.013 shall be held.
- B. In the case of a conversion of apartments or rental units to condominiums, a minimum of 120 days' notice shall be afforded any tenants, prior to conversion. All the provisions of the Oregon Revised Statutes shall be met, and a plat, together with a homeowners' association agreement and By-Laws, shall be submitted for Development Review Board consideration as part of the public hearing process.
- C. The owner will bear the burden of proving that there are an adequate number of vacant rental units available within Wilsonville, at approximately the same costs as the units that are proposed for conversion, to house those people who may be displaced as a result of the conversion.

(.08) Lot line adjustments shall be subject to the standards and procedures established in Sections 4.233. In no case shall the boundaries between adjoining lots or parcels be altered without compliance with those standards.

Response: One (1) lot line adjustment is proposed as part of this consolidated land use application. The lot line adjustment will adjust the boundary line between tax lot 101 and tax lot 600. The proposed lot line adjustment will have no effect on the tax lot 680, 690, and 197 deed lot boundaries. The lot line adjustment is further described in the applicant's responses to Section 4.233.

Section 4.233 Lot Line Adjustments

- (.01) Property owners wishing to alter the location of a property line that separates adjoining properties, without creating a new lot or parcel in the process, may apply for approval of a lot line adjustment. Applications for lot line adjustment shall be processed through either of the following:
- A. Administrative Review, through the procedures outlined in Section 4.035; or
 - B. As part of a partition or subdivision process, where new lots or parcels are being created at the same time as the existing lot lines are being reconfigured.

Response: The applicant seeks one (1) lot line adjustment as part of this consolidated application. The lot line adjustment will adjust the boundary line between tax lot 600 and tax lot 101. Because no new lot or parcel is being created, the requested lot line adjustment is subject to an Administrative Review.

(.02) The lots or parcels resulting from a lot line adjustment shall conform to all requirements of the zone. Except, however, if either of the subject properties is a legal non-conforming lot at the time of the application, the requirements of Section 4.192 (Non-Conforming Lots) shall be followed.

Response: A lot line adjustment diagram is included as Sheet C1 of Exhibit E. Legal descriptions and maps for the lot line adjustments are included as Exhibit N. The lot line adjustment will adjust the boundary line between tax lot 600 and tax lot 101. Approximately 217,000 SF will be transferred from tax lot 600 to tax lot 101 through the lot line adjustment process. Below are the existing and resulting areas of tax lots 600 and 101.

Lot Line Adjustment Area		
Tax Lot	Existing Area (SF)	Resulting Area (SF)
600	572,706	301,384
101	35,853	307,175

The applicant's responses to Section 4.135 demonstrate the adjusted lots' compliance with the requirements of the PDI and FDAHI zones.

- (.03) *The dedication of property to a unit of government, where the property being dedicated is added to property that is already in public ownership, may be completed by deed without requiring compliance with this Section.*

Response: No dedication of property is proposed or warranted as part of the proposed development.

Section 4.236 General Requirements – Streets

- (.01) *Conformity to the Transportation System Plan. Land divisions shall conform to and be in harmony with the Transportation Systems Plan, the Bicycle and Pedestrian Master Plan, and the Parks and Recreation Master Plan.*

- (.02) *Relation to Adjoining Street System:*

- A. *A land division shall provide for the continuation of the principal streets existing in the adjoining area, or of their proper projection when adjoining property is not developed, and shall be of a width not less than the minimum requirements for streets set forth in these regulations. Where, in the opinion of the Planning Director or Development Review Board, topographic conditions make such continuation or conformity impractical, an exception may be made. In cases where the Board or Planning Commission has adopted a plan or plat of a neighborhood or area of which the proposed land division is a part, the subdivision shall conform to such adopted neighborhood or area plan.*
- B. *Where the plat submitted covers only a part of the applicant's tract, a sketch of the prospective future street system of the unsubmitted part shall be furnished and the street system of the part submitted shall be considered in the light of adjustments and connections with the street system of the part not submitted.*
- C. *At any time when an applicant proposes a land division and the Comprehensive Plan would allow for the proposed lots to be further divided, the City may require an arrangement of lots and streets such as to permit a later resubdivision in conformity to the street plans and other requirements specified in these regulations.*

Response: No land division is proposed. The proposed lot line adjustment does not alter the surrounding street system.

- (.03) *All streets shall conform to the standards set forth in Section 4.177 and the block size requirements of the zone.*

Response: The proposed lot line adjustment does not alter the surrounding street system or block size. Compliance with the standards of Section 4.177 and block size requirements is explained in the Applicant's responses to Section 4.177. This standard is met.

- (.04) *Creation of Easements. The Planning Director or Development Review Board may approve an easement to be established without full compliance with these regulations, provided such an easement is the only reasonable method by which a portion of a lot large enough to allow partitioning into two parcels may be provided with vehicular access and adequate utilities. If the proposed lot is large enough to divide into more than two parcels, a street dedication may be required.*

Response: No land division is proposed. No creation of easement(s) is proposed.

- (.05) *Topography. The layout of streets shall give suitable recognition to surrounding topographical conditions in accordance with the purpose of these regulations.*

Response: No land division is proposed. The proposed lot line adjustment does not alter the surrounding street system.

- (.06) *Reserve Strips. The Planning Director or Development Review Board may require the applicant to create a reserve strip controlling the access to a street. Said strip is to be placed under the jurisdiction of the City Council, when the Director or Board determine that a strip is necessary:*
- A. *To prevent access to abutting land at the end of a street in order to assure the proper extension of the street pattern and the orderly development of land lying beyond the street; or*
 - B. *To prevent access to the side of a street on the side where additional width is required to meet the right-of-way standards established by the City; or*
 - C. *To prevent access to land abutting a street of the land division but not within the tract or parcel of land being divided; or*
 - D. *To prevent access to land unsuitable for building development.*

Response: There is no boundary of the proposed Lot Line Adjustment boundary where creation of a reservation strip is warranted. This standard is not applicable.

- (.07) *Future Expansion of Street. When necessary to give access to, or permit a satisfactory future division of, adjoining land, streets shall be extended to the boundary of the land division and the resulting dead-end street may be approved without a turn-around. Reserve strips and street plugs shall be required to preserve the objective of street extension. Notification that the street is planned for future extension shall be posted on the stub street.*

Response: No land division is proposed. SW 5th Street has recently been extended along the southern boundary of the subject property, connecting SW 5th Street to SW Industrial Way. As SW 5th Street has recently been extended (expanded), this provision is not applicable.

- (.08) *Existing Streets. Whenever existing streets adjacent to or within a tract are of inadequate width, additional right-of-way shall conform to the designated width in this Code or in the Transportation Systems Plan.*

Response: No land division is proposed. The subject site has frontage on SW 5th Street. Per Staff's notes from the Pre-Application Conference, SW 5th Street (after the current construction completion) is fully improved and no street improvements and/or dedication are required.

- (.09) *Street Names. No street names will be used which will duplicate or be confused with the names of existing streets, except for extensions of existing streets. Street names and numbers shall conform to the established name system in the City, and shall be subject to the approval of the City Engineer.*

Response: No land division is proposed. No new street names are proposed. This standard is not applicable.

Section 4.237 General Requirements – Other

- (.01) *Blocks:*
- A. *The length, width, and shape of blocks shall be designed with due regard to providing adequate building sites for the use contemplated, consideration of needs for convenient access, circulation, control, and safety of pedestrian, bicycle, and motor vehicle traffic, and recognition of limitations and opportunities of topography.*
 - B. *Sizes: Blocks shall not exceed the sizes and lengths specified for the zone in which they are located unless topographical conditions or other physical constraints necessitate larger blocks. Larger blocks shall only be approved where specific findings are made justifying the size, shape, and configuration.*

Response: The block size will be unchanged with the proposed improvements. This standard is met.

(.02) *Easements:*

- A. *Utility lines. Easements for sanitary or storm sewers, drainage, water mains, electrical lines or other public utilities shall be dedicated wherever necessary. Easements shall be provided consistent with the City's Public Works Standards, as specified by the City Engineer or Planning Director. All of the public utility lines within and adjacent to the site shall be installed within the public right-of-way or easement; with underground services extending to the private parcel constructed in conformance to the City's Public Works Standards. All franchise utilities shall be installed within a public utility easement. All utilities shall have appropriate easements for construction and maintenance purposes.*
- B. *Water courses. Where a land division is traversed by a water course, drainage way, channel or stream, there shall be provided a storm water easement or drainage right-of-way conforming substantially with the lines of the water course, and such further width as will be adequate for the purposes of conveying storm water and allowing for maintenance of the facility or channel. Streets or parkways parallel to water courses may be required.*

Response: No public utilities are proposed as part of this application. Regarding the need for public utility easements, this application includes a request for vacation of the public right of way located in the central portion of the site. In previous City actions affecting the subject property, Urban Renewal Agency Resolution No. 262 (2016) identified a section of property (See Sheet 11 of 14, of Exhibit J) as a possible alignment for a road connection from Bailey Street to Kinsman Road. Urban Renewal Agency Resolution No. 262 was subsequently amended by URA Resolution No. 280 (10th Amendment to the Year 2000 Plan). The 10th Amendment to the Year 2000 Plan boundary change clarified the location of the new east-west connector based on the City Council decision that it be a 5th Street extension and not a Bailey Street extension.

As evidenced in the City's Pre-Application Engineering Division notes in Exhibit I, existing public utilities capable of serving the area are located in both SW 5th Street to the south and Kinsman Road to the west. Because no public utilities are located within the right-of-way requested for vacation, no public utility easement is required within the area of the proposed right-of-way vacation.

(.03) *Pedestrian and bicycle pathways. An improved public pathway shall be required to transverse the block near its middle if that block exceeds the length standards of the zone in which it is located.*

- A. *Pathways shall be required to connect to culs-de-sac or to pass through unusually shaped blocks.*
- B. *Pathways required by this subsection shall have a minimum width of ten feet unless they are found to be unnecessary for bicycle traffic, in which case they are to have a minimum width of six feet.*

Response: No pathways are required under this provision. The City has constructed Tonquin Trail on the south side of SW 5th Street and a pedestrian path on the north side of SW 5th Street. This standard is met.

(.04) *Tree planting. Tree planting plans for a land division must be submitted to the Planning Director and receive the approval of the Director or Development Review Board before the planting is begun. Easements or other documents shall be provided, guaranteeing the City the right to enter the site and plant, remove, or maintain approved street trees that are located on private property.*

Response: A planting plan is included as the L-series Sheets of Exhibit E. A final tree planting plan will include revisions based on recommendations to the arborist, and will be submitted at time of permit.

- (.05) *Lot Size and shape. The lot size, width, shape and orientation shall be appropriate for the location of the land division and for the type of development and use contemplated. Lots shall meet the requirements of the zone where they are located.*
- A. *In areas that are not served by public sewer, an on-site sewage disposal permit is required from the City. If the soil structure is adverse to on-site sewage disposal, no development shall be permitted until sewer service can be provided.*
 - B. *Where property is zoned or deeded for business or industrial use, other lot widths and areas may be permitted at the discretion of the Development Review Board. Depth and width of properties reserved or laid out for commercial and industrial purposes shall be adequate to provide for the off-street service and parking facilities required by the type of use and development contemplated.*
 - C. *In approving an application for a Planned Development, the Development Review Board may waive the requirements of this section and lot size, shape, and density shall conform to the Planned Development conditions of approval.*

Response: The proposed lot size and shape is of a configuration and size to accommodate industrial development, as allowed in the PDI zone. The lot meets all dimensional standards as described in response to Section 4.135. This standard is met.

- (.06) *Access. The division of land shall be such that each lot shall have a minimum frontage on a street or private drive, as specified in the standards of the relative zoning districts. This minimum frontage requirement shall apply with the following exceptions:*
- A. *A lot on the outer radius of a curved street or tract with a private drive, or facing the circular end of a cul-de-sac shall have frontage of not less than 25 feet upon a street or tract with a private drive, measured on the arc.*
 - B. *The Development Review Board may waive lot frontage requirements where in its judgment the waiver of frontage requirements will not have the effect of nullifying the intent and purpose of this regulation or if the Board determines that another standard is appropriate because of the characteristics of the overall development.*

Response: No division of land is proposed. This standard is not applicable.

- (.07) *Through lots. Through lots shall be avoided except where essential to provide separation of residential development from major traffic arteries or adjacent non-residential activity or to overcome specific disadvantages of topography and orientation. A planting screen easement of at least ten feet, across which there shall be no access, may be required along the line of lots abutting such a traffic artery or other disadvantageous use. Through lots with planting screens shall have a minimum average depth of 100 feet. The Development Review Board may require assurance that such screened areas be maintained as specified in Section 4.176.*

Response: The creation of a through-lot is not proposed. This standard is not applicable.

- (.08) *Lot side lines. The side lines of lots, as far as practicable for the purpose of the proposed development, shall run at right angles to the street or tract with a private drive upon which the lots face.*

Response: The Subject Site's side lot line does not abut any street or tract with a private drive upon which the lot faces. This standard is not applicable.

- (.09) *Large lot land divisions. In dividing tracts which at some future time are likely to be re-divided, the location of lot lines and other details of the layout shall be such that re-division may readily take place without violating the requirements of these regulations and without interfering with the orderly development of streets. Restriction of buildings within future street locations shall be made a matter of record if the Development Review Board considers it necessary.*

Response: No division of land is proposed. This standard is not applicable.

(.10) *Building line. The Planning Director or Development Review Board may establish special building setbacks to allow for the future redivision or other development of the property or for other reasons specified in the findings supporting the decision. If special building setback lines are established for the land division, they shall be shown on the final plat.*

Response: No division of land is proposed. This standard is not applicable.

(.11) *Build-to line. The Planning Director or Development Review Board may establish special build-to lines for the development, as specified in the findings and conditions of approval for the decision. If special build-to lines are established for the land division, they shall be shown on the final plat.*

Response: No division of land is proposed. This standard is not applicable.

(.12) *Land for public purposes. The Planning Director or Development Review Board may require property to be reserved for public acquisition, or irrevocably offered for dedication, for a specified period of time.*

Response: No division of land is proposed. This standard is not applicable.

(.13) *Corner lots. Lots on street intersections shall have a corner radius of not less than ten feet.*

Response: The proposed lot configuration does not create a corner lot. This standard is not applicable.

Section 4.250 Lots of Record

All lots of record that have been legally created prior to the adoption of this ordinance shall be considered to be legal lots. Tax lots created by the County Assessor are not necessarily legal lots of record.

Response: Documentation providing lot of record validation is included as Exhibit L. This provision is satisfied.

Section 4.260 Improvements – Procedures

In addition to other requirements, improvements installed by the developer, either as a requirement of these regulations or at the developer's own option, shall conform to the requirements of this Code and improvement standards and specifications of the City. The improvements shall be installed in accordance with the City's Public Works Standards.

Response: Compliance with this standard will be demonstrated at time of permitting.

Section 4.262 Improvements – Requirements

(.01) *Streets.*

Streets within or partially within the development shall be graded for the entire right-of-way width, constructed and surfaced in accordance with the Transportation Systems Plan and City Public Works Standards. Existing streets which abut the development shall be graded, constructed, reconstructed, surfaced or repaired as determined by the City Engineer.

(.02) *Curbs. Curbs shall be constructed in accordance with standards adopted by the City.*

(.03) *Sidewalks. Sidewalks shall be constructed in accordance with standards adopted by the City.*

(.04) *Sanitary sewers. When the development is within 200 feet of an existing public sewer main, sanitary sewers shall be installed to serve each lot or parcel in accordance with standards adopted by the City. When the development is more than 200 feet from an existing public sewer main, the City Engineer may approve an alternate sewage disposal system.*

(.05) *Drainage. Storm drainage, including detention or retention systems, shall be provided as determined by the City Engineer.*

- (.06) *Underground utility and service facilities. All new utilities shall be subject to the standards of Section 4.300 (Underground Utilities). The developer shall make all necessary arrangements with the serving utility to provide the underground services in conformance with the City's Public Works Standards.*
- (.07) *Streetlight standards. Streetlight standards shall be installed in accordance with regulations adopted by the City.*
- (.08) *Street signs. Street name signs shall be installed at all street intersections and dead-end signs at the entrance to all dead-end streets and culs-de-sac in accordance with standards adopted by the City. Other signs may be required by the City Engineer.*
- (.09) *Monuments. Monuments shall be placed at all lot and block corners, angle points, points of curves in streets, at intermediate points and shall be of such material, size and length as required by State Law. Any monuments that are disturbed before all improvements are completed by the developer and accepted by the City shall be replaced to conform to the requirements of State Law.*
- (.10) *Water. Water mains and fire hydrants shall be installed to serve each lot in accordance with City standards.*

Response: No public improvements are proposed or warranted to be constructed as part of this development. This standard is not applicable.

Section 4.264 Improvements – Assurance

- (.01) *A certificate shall be signed by the City Engineer certifying that the developer has complied with one of the following alternatives:*
 - A. *All improvements have been installed in accordance with the requirements of these regulations and with the action of the Planning Director or Development Review Board, giving conditional approval of the preliminary plat, or*
 - B. *A bond or other form of security satisfactory to the Community Development Director or a certified check, equal to one and one-half times the City Engineer's estimate of the cost of such improvement, has been posted with the City to assure completion of all required improvements, or*
 - C. *Deed restriction to the effect that no lots may be sold until improvements have been completed and accepted by the City, a bond or other security satisfactory to the City Council or a certified check is posted, or other means approved by the Community Development Director, giving full assurance that the improvements will be completed.*
 - D. *If, at the termination of two years, the work has not been completed, and no extension has been granted, the certified check or bond may be forfeited and the improvements constructed at the direction of the City Engineer. If the work has been completed to the satisfaction of the City Engineer, the certified check or bond shall be released.*

Response: No public improvements are proposed or warranted to be constructed as part of this development. This standard is not applicable.

Section 4.270 Variance from Land Division Standards

Response: No Variance from the Land Division Standards is requested. This standard is not applicable.

UNDERGROUND UTILITIES

Section 4.300. General

- (.01) *The City Council deems it reasonable and necessary in order to accomplish the orderly and desirable development of land within the corporate limits of the City, to require the underground installation of utilities in all new developments.*

- (.02) *After the effective date of this Code, the approval of any development of land within the City will be upon the express condition that all new utility lines, including but not limited to those required for power, communication, street lighting, gas, cable television services and related facilities, shall be placed underground.*
- (.03) *The construction of underground utilities shall be subject to the City's Public Works Standards and shall meet applicable requirements for erosion control and other environmental protection.*

Section 4.310. Exceptions

Section 4.300 of this Code shall not apply to surface-mounted transformers, surface-mounted connection boxes, wireless communication facilities, and meter cabinets and other appurtenances which are reasonably necessary to be placed above ground, or to temporary utility service facilities during construction, or to high capacity electric and communication feeder lines, or to utility transmission lines operating at 50,000 volts or more.

Response: The applicant's proposed development plans include installation of underground storm sewer pipes as shown on Sheet C3 of Exhibit E. There are existing high voltage power lines running in a north-south orientation above the eastern edge of tax lot 101. As excepted by this provision, the high voltage power lines will remain as is.

Section 4.320. Requirements

- (.01) *The developer or subdivider shall be responsible for and make all necessary arrangements with the serving utility to provide the underground services (including cost of rearranging any existing overhead facilities). All such underground facilities as described shall be constructed in compliance with the rules and regulations of the Public Utility Commission of the State of Oregon relating to the installation and safety of underground lines, plant, system, equipment and apparatus.*
- (.02) *The location of the buried facilities shall conform to standards supplied to the subdivider by the City. The City also reserves the right to approve location of all surface-mounted transformers.*
- (.03) *Interior easements (back lot lines) will only be used for storm or sanitary sewers, and front easements will be used for other utilities unless different locations are approved by the City Engineer. Easements satisfactory to the serving utilities shall be provided by the developer and shall be set forth on the plat.*

Response: The proposed stormwater system connection point has been prepared in consultation with City staff. The submitted plans demonstrate the feasibility of achieving compliance. Detailed plans will be submitted for permitting prior to construction. Condition(s) of approval can assure compliance in the permitting and construction process.

Section 4.400. Purpose

(.01) *Excessive uniformity, inappropriateness or poor design of the exterior appearance of structures and signs and the lack of proper attention to site development and landscaping in the business, commercial, industrial and certain residential areas of the City hinders the harmonious development of the City, impairs the desirability of residence, investment or occupation in the City, limits the opportunity to attain the optimum use in value and improvements, adversely affects the stability and value of property, produces degeneration of property in such areas and with attendant deterioration of conditions affecting the peace, health and welfare, and destroys a proper relationship between the taxable value of property and the cost of municipal services therefor.*

- (.02) *The City Council declares that the purposes and objectives of site development requirements and the site design review procedure are to:*
 - A. *Assure that Site Development Plans are designed in a manner that insures proper functioning of the site and maintains a high quality visual environment.*

- B. *Encourage originality, flexibility and innovation in site planning and development, including the architecture, landscaping and graphic design of said development;*
- C. *Discourage monotonous, drab, unsightly, dreary and inharmonious developments;*
- D. *Conserve the City's natural beauty and visual character and charm by assuring that structures, signs and other improvements are properly related to their sites, and to surrounding sites and structures, with due regard to the aesthetic qualities of the natural terrain and landscaping, and that proper attention is given to exterior appearances of structures, signs and other improvements;*
- E. *Protect and enhance the City's appeal and thus support and stimulate business and industry and promote the desirability of investment and occupancy in business, commercial and industrial purposes;*
- F. *Stabilize and improve property values and prevent blighted areas and, thus, increase tax revenues;*
- G. *Insure that adequate public facilities are available to serve development as it occurs and that proper attention is given to site planning and development so as to not adversely impact the orderly, efficient and economic provision of public facilities and services.*
- H. *Achieve the beneficial influence of pleasant environments for living and working on behavioral patterns and, thus, decrease the cost of governmental services and reduce opportunities for crime through careful consideration of physical design and site layout under defensible space guidelines that clearly define all areas as either public, semi-private, or private, provide clear identity of structures and opportunities for easy surveillance of the site that maximize resident control of behavior -- particularly crime;*
- I. *Foster civic pride and community spirit so as to improve the quality and quantity of citizen participation in local government and in community growth, change and improvements;*
- J. *Sustain the comfort, health, tranquility and contentment of residents and attract new residents by reason of the City's favorable environment and, thus, to promote and protect the peace, health and welfare of the City.*

Response: The applicant's submitted plans in Exhibit E respond to applicable development standards. The plans demonstrate that the proposed development will function properly and will contribute to producing the desired quality of development in the PDI zone area. As no new buildings are proposed, many of the design standards are inapplicable to the proposed development. Although many design standards are inapplicable, the applicant's design team has paid significant attention to the retention of trees, preservation of the SROZ and accompanying Impact Area, vegetated stormwater facilities, and site landscaping to soften the proposed parking area.

Section 4.420. Jurisdiction and Powers of the Board

(.01) Application of Section. Except for single-family or two-family dwellings in any residential zoning district, and in the Village zone, row houses or apartments, no Building Permit shall be issued for a new building or major exterior remodeling of an existing building, and no Sign Permit, except as permitted in Sections 4.156.02 and 4.156.05, shall be issued for the erection or construction of a sign relating to such new building or major remodeling, until the plans, drawings, sketches and other documents required for a Sign Permit application have been reviewed and approved by the Board.

Response: The applicant is not requesting approval of a sign. This standard is not applicable.

(.02) Development in Accord with Plans. Construction, site development and landscaping shall be carried out in substantial accord with the plans, drawings, sketches and other documents approved by the Board, unless altered with Board approval. Nothing in this subsection shall be construed to prevent ordinary repair, maintenance and replacement of any part of the building or landscaping which does not involve a substantial change from the purpose of Section 4.400. If the Board objects to such proposed

changes, they shall be subject to the procedures and requirements of the site design review process applicable to new proposals.

Response: The applicant intends to construct a project that aligns with the general form and design depicted in the accompanying plans, subject to possible minor alterations that may arise during preparation of construction drawings for permit review. This standard is met.

(.03) *Variances. The Board may authorize variances from the site development requirements, based upon the procedures, standards and criteria listed in Section 4.196. Variances shall be considered in conjunction with the site design review process.*

Response: No variance is requested.

Section 4.421. Criteria and Application of Design Standards

(.01) *The following standards shall be utilized by the Board in reviewing the plans, drawings, sketches and other documents required for Site Design Review. These standards are intended to provide a frame of reference for the applicant in the development of site and building plans as well as a method of review for the Board. These standards shall not be regarded as inflexible requirements. They are not intended to discourage creativity, invention and innovation. The specifications of one or more particular architectural styles is not included in these standards. (Even in the Boones Ferry Overlay Zone, a range of architectural styles will be encouraged.)*

A. *Preservation of Landscape. The landscape shall be preserved in its natural state, insofar as practicable, by minimizing tree and soils removal, and any grade changes shall be in keeping with the general appearance of neighboring developed areas.*

Response: The proposed development on site is limited to the northern and eastern boundary of the site, as well as site grading in the middle of the site. The areas of the proposed development have been previously used for agricultural purposes, and are not in a natural state. Notably, Coffee Creek runs north/south through the western portion of the site and has an associated SROZ riparian corridor area. The western portion of the Subject Site will be maintained. This standard is met.

B. *Relation of Proposed Buildings to Environment. Proposed structures shall be located and designed to assure harmony with the natural environment, including protection of steep slopes, vegetation and other naturally sensitive areas for wildlife habitat and shall provide proper buffering from less intensive uses in accordance with Sections 4.171 and 4.139 and 4.139.5. The achievement of such relationship may include the enclosure of space in conjunction with other existing buildings or other proposed buildings and the creation of focal points with respect to avenues of approach, street access or relationships to natural features such as vegetation or topography.*

Response: No new buildings are proposed. This standard is not applicable.

C. *Drives, Parking and Circulation. With respect to vehicular and pedestrian circulation, including walkways, interior drives and parking, special attention shall be given to location and number of access points, general interior circulation, separation of pedestrian and vehicular traffic, and arrangement of parking areas that are safe and convenient and, insofar as practicable, do not detract from the design of proposed buildings and structures and the neighboring properties.*

Response: The proposed parking area will be accessed via the existing site circulation system which connects to SW OrePac Avenue. The proposed driveway's use will be limited to truck circulation. Concentrating truck maneuvering and access at the southeast corner of the site allows passenger vehicles to travel safely to the vehicle parking lots. As the proposed driveway is intended for truck use, no pedestrian connection is proposed. This standard is met.

D. *Surface Water Drainage. Special attention shall be given to proper site surface drainage so that removal of surface waters will not adversely affect neighboring properties of the public storm drainage system.*

Response: The proposed plans (see Exhibit E) include site grading for positive on-site drainage to surface facilities for water quality treatment and detention, with discharge to the existing public system in SW 5th Street. This standard is met.

E. *Utility Service. Any utility installations above ground shall be located so as to have a harmonious relation to neighboring properties and site. The proposed method of sanitary and storm sewage disposal from all buildings shall be indicated.*

Response: No new above ground public utilities are proposed. As shown on Sheet C2 and C3, vegetated stormwater facilities are proposed. These facilities will be harmonious to the surrounding groundcover and landscaping.

F. *Advertising Features. In addition to the requirements of the City's sign regulations, the following criteria should be included: the size, location, design, color, texture, lighting and materials of all exterior signs and outdoor advertising structures or features shall not detract from the design of proposed buildings and structures and the surrounding properties.*

Response: No signs are proposed as part of this application.

G. *Special Features. Exposed storage areas, exposed machinery installations, surface areas, truck loading areas, utility buildings and structures and similar accessory areas and structures shall be subject to such setbacks, screen plantings or other screening methods as shall be required to prevent their being incongruous with the existing or contemplated environment and its surrounding properties. Standards for screening and buffering are contained in Section 4.176.*

Response: No exposed storage areas, exposed machinery installations, surface areas, truck loading areas, utility buildings, or accessory structures are proposed. This standard is not applicable.

(.02) *The standards of review outlined in Sections (a) through (g) above shall also apply to all accessory buildings, structures, exterior signs and other site features, however related to the major buildings or structures.*

Response: The submitted plans include all known features of the proposed development project, to support analysis consistent with this provision.

(.03) *The Board shall also be guided by the purpose of Section 4.400, and such objectives shall serve as additional criteria and standards.*

Response: The applicant has responded to the Purpose statements in Section 4.400 above.

(.04) *Conditional application. The Planning Director, Planning Commission, Development Review Board or City Council may, as a Condition of Approval for a zone change, subdivision, land partition, variance, conditional use, or other land use action, require conformance to the site development standards set forth in this Section.*

Response: The applicant is seeking Site Design Review approval as part of this application package, so no approval condition requiring conformance to site development standards is necessary. This standard does not apply.

(.05) *The Board may attach certain development or use conditions in granting an approval that are determined necessary to insure the proper and efficient functioning of the development, consistent with*

the intent of the Comprehensive Plan, allowed densities and the requirements of this Code. In making this determination of compliance and attaching conditions, the Board shall, however, consider the effects of this action on the availability and cost of needed housing. The provisions of this section shall not be used in such a manner that additional conditions either singularly or accumulatively have the effect of unnecessarily increasing the cost of housing or effectively excluding a needed housing type.

Response: The applicant recognizes the DRB's authority to impose conditions of approval necessary to ensure conformance to adopted Code standards; however, the proposed use and development are consistent with the subject property's proposed PDI zoning and compatible with the adjoining industrial zoning. For these reasons, no imposition of additional conditions over and above Code standards is necessary or warranted to meet the intent of the Comprehensive Plan or to protect the best interests of the surrounding properties and neighborhoods, the City as a whole, and the intent of this Code. This criterion is met without additional conditions.

(.06) The Board or Planning Director may require that certain paints or colors of materials be used in approving applications. Such requirements shall only be applied when site development or other land use applications are being reviewed by the City.

- A. Where the conditions of approval for a development permit specify that certain paints or colors of materials be used, the use of those paints or colors shall be binding upon the applicant. No Certificate of Occupancy shall be granted until compliance with such conditions has been verified.*
- B. Subsequent changes to the color of a structure shall not be subject to City review unless the conditions of approval under which the original colors were set included a condition requiring a subsequent review before the colors could be changed.*

Response: No new buildings or structures are proposed; therefore, no paints or colors are proposed. This standard is not applicable.

Section 4.430. Location, Design and Access Standards for Mixed Solid Waste and Recycling Areas

Response: As no new building area is proposed, no additional mixed solid waste and recycling areas are required. This Section is not applicable.

Section 4.440. Procedure

(.01) Submission of Documents. A prospective applicant for a building or other permit who is subject to site design review shall submit to the Planning Department, in addition to the requirements of Section 4.035, the following:

- A. A site plan, drawn to scale, showing the proposed layout of all structures and other improvements including, where appropriate, driveways, pedestrian walks, landscaped areas, fences, walls, off-street parking and loading areas, and railroad tracks. The site plan shall indicate the location of entrances and exits and direction of traffic flow into and out of off-street parking and loading areas, the location of each parking space and each loading berth and areas of turning and maneuvering vehicles. The site plan shall indicate how utility service and drainage are to be provided.*
- B. A Landscape Plan, drawn to scale, showing the location and design of landscaped areas, the variety and sizes of trees and plant materials to be planted on the site, the location and design of landscaped areas, the varieties, by scientific and common name, and sizes of trees and plant materials to be retained or planted on the site, other pertinent landscape features, and irrigation systems required to maintain trees and plant materials. An inventory, drawn at the same scale as the Site Plan, of existing trees of 4" caliper or more is required. However, when large areas of trees are proposed to be retained*

undisturbed, only a survey identifying the location and size of all perimeter trees in the mass in necessary.

- C. *Architectural drawings or sketches, drawn to scale, including floor plans, in sufficient detail to permit computation of yard requirements and showing all elevations of the proposed structures and other improvements as they will appear on completion of construction. Floor plans shall also be provided in sufficient detail to permit computation of yard requirements based on the relationship of indoor versus outdoor living area, and to evaluate the floor plan's effect on the exterior design of the building through the placement and configuration of windows and doors.*
- D. *A Color Board displaying specifications as to type, color, and texture of exterior surfaces of proposed structures. Also, a phased development schedule if the development is constructed in stages.*
- E. *A sign Plan, drawn to scale, showing the location, size, design, material, color and methods of illumination of all exterior signs.*
- F. *The required application fee.*

Response: The relevant required documents listed above (Items A and B) have been included in this application package as Exhibit E, with the exception of the fee which was paid separately. This standard is met.

(.02) As soon as possible after the preparation of a staff report, a public hearing shall be scheduled before the Development Review Board. In accordance with the procedures set forth in Section 4.010(2) and 4.012, the Development Review Board shall review and approve, approve with conditions, or deny the proposed architectural, site development, landscaping or sign plans of the applicant. If the Board finds that additional information or time are necessary to render a decision, the matter may be continued to a date certain. The applicant shall be immediately notified in writing of any such continuation or delay together with the scheduled date of review.

Response: This provision provides procedural guidance for implementation and requires no evidence within the applicant's narrative.

Section 4.441. Effective Date of Decisions

A decision of the Board shall become effective fourteen (14) calendar days after the date of the decision, unless the decision is appealed to, or called up by, the Council. If the decision of the Board is appealed to, or called up by, the City Council, the decision of the Council shall become effective immediately.

Response: This provision provides procedural guidance for implementation and requires no evidence from the applicant.

Section 4.442. Time Limit on Approval

Site design review approval shall be void after two (2) years unless a building permit has been issued and substantial development pursuant thereto has taken place; or an extension is granted by motion of the Board.

Response: The applicant intends to seek a building permit and begin construction within the timeframes outlined by Code. This standard is met.

Section 4.443. Preliminary Consideration

An applicant may request preliminary consideration by the Board of general plans prior to seeking a building permit. When seeking preliminary consideration, the applicant shall submit a site plan showing the proposed structures, improvements and parking, together with a general description of the plans. The Board shall approve or reject all or part of the applicant's general plan within the normal time requirements of a formal application. Preliminary approval shall be deemed to be approval of the final plan to the extent that the final design contains the characteristics of the preliminary design.

Response: The applicant has submitted for concurrent Stage I and Stage II Planned Development Review pursuant to this Section.

Section 4.450. Installation of Landscaping

(.01) All landscaping required by this section and approved by the Board shall be installed prior to issuance of occupancy permits, unless security equal to one hundred and ten percent (110%) of the cost of the landscaping as determined by the Planning Director is filed with the City assuring such installation within six (6) months of occupancy. "Security" is cash, certified check, time certificates of deposit, assignment of a savings account or such other assurance of completion as shall meet with the approval of the City Attorney. In such cases the developer shall also provide written authorization, to the satisfaction of the City Attorney, for the City or its designees to enter the property and complete the landscaping as approved. If the installation of the landscaping is not completed within the six-month period, or within an extension of time authorized by the Board, the security may be used by the City to complete the installation. Upon completion of the installation, any portion of the remaining security deposited with the City shall be returned to the applicant.

(.02) Action by the City approving a proposed landscape plan shall be binding upon the applicant. Substitution of plant materials, irrigation systems, or other aspects of an approved landscape plan shall not be made without official action of the Planning Director or Development Review Board, as specified in this Code.

(.03) All landscaping shall be continually maintained, including necessary watering, weeding, pruning, and replacing, in a substantially similar manner as originally approved by the Board, unless altered with Board approval.

(.04) If a property owner wishes to add landscaping for an existing development, in an effort to beautify the property, the Landscape Standards set forth in Section 4.176 shall not apply and no Plan approval or permit shall be required. If the owner wishes to modify or remove landscaping that has been accepted or approved through the City's development review process, that removal or modification must first be approved through the procedures of Section 4.010.

Response: The applicant acknowledges the City's authority under these provisions to require installation and maintenance of landscape features in accordance with construction plans after approval, and applicant accepts responsibility for care, maintenance, and procedures for approval of non-additive modifications to landscape features.

Type C Tree Plan Review

Section 4.600 Purpose and Declaration

(.01) Rapid growth, the spread of development, need for water and increasing demands upon natural resources have the effect of encroaching upon, despoiling, or eliminating many of the trees, other forms of vegetation, and natural resources and processes associated therewith which, if preserved and maintained in an undisturbed and natural condition, constitute important physical, aesthetic, recreational and economic assets to existing and future residents of the City of Wilsonville.

(.02) Specifically, the City Council finds that:
A. Woodland growth protects public health through the absorption of air pollutants and contamination, through the reduction of excessive noise and mental and physical damage related to noise pollution, and through its cooling effect in the summer months, and insulating effects in winter;

- B. *Woodlands provide for public safety through the prevention of erosion, siltation, and flooding; and*
- C. *Trees make a positive contribution to water quality and water supply by absorbing rainfall, controlling surface water run-off, and filtering and assisting in ground water recharge; and*
- D. *Trees and woodland growth are an essential component of the general welfare of the City of Wilsonville by producing play areas for children and natural beauty, recreation for all ages and an irreplaceable heritage for existing and future City residents.*

(.03) Therefore, the purposes of this subchapter are:

- A. *To preserve Significant Resource Overlay Zone areas, recognizing that development can and will occur.*
- B. *To provide for the protection, preservation, proper maintenance and use of trees and woodlands in order to protect natural habitat and prevent erosion.*
- C. *To protect trees and other wooded areas for their economic contribution to local property values when preserved, and for their natural beauty and ecological or historical significance.*
- D. *To protect water quality, control surface water run-off, and protect ground water recharge.*
- E. *To reflect the public concern for these natural resources in the interest of health, safety and general welfare of Wilsonville residents.*
- F. *To encourage replanting where trees are removed.*

Section 4.600.20. Applicability of Subchapter

(.01) The provisions of this subchapter apply to the United States and the State of Oregon, and to their agencies and subdivisions, including the City of Wilsonville, and to the employees and agents thereof.

(.02) By this subchapter, the City of Wilsonville regulates forest practices on all lands located within its urban growth boundary, as provided by ORS 527.722.

(.03) The provisions of this subchapter apply to all land within the City limits, including property designated as a Significant Resource Overlay Zone or other areas or trees designated as protected by the Comprehensive Plan, City zoning map, or any other law or ordinance; except that any tree activities in the Willamette River Greenway that are regulated by the provisions of WC 4.500 - 4.514 and requiring a conditional use permit shall be reviewed by the DRB under the application and review procedures set forth for Tree Removal Permits.

Response: The subject site is located in the City of Wilsonville. This Subchapter is applicable.

Section 4.600.30. Tree Removal Permit Required

(.01) Requirement Established. No person shall remove any tree without first obtaining a Tree Removal Permit (TRP) as required by this subchapter.

(.02) Tree Removal Permits will be reviewed according to the standards provided for in this subchapter, in addition to all other applicable requirements of Chapter 4.

(.03) Although tree activities in the Willamette River Greenway are governed by WC 4.500 - 4.514, the application materials required to apply for a conditional use shall be the same as those required for a Type B or C permit under this subchapter, along with any additional materials that may be required by the Planning Department. An application for a Tree Removal Permit under this section shall be reviewed by the Development Review Board.

Response: This application includes a request for a Type C Tree Removal Permit.

Section 4.600.40. Exceptions

Response: The applicant is not requesting an exemption.

Section 4.600.50. Application For Tree Removal Permit

(.01) Application for Permit. A person seeking to remove one or more trees shall apply to the Director for a Tree Removal Permit for a Type A, B, C, or D permit, depending on the applicable standards as provided in this subchapter.

(A) An application for a tree removal permit that does not meet the requirements of Type A may be submitted as a Type B application.

(.02) Time of Application. Application for a Tree Removal Permit shall be made before removing or transplanting trees, except in emergency situations as provided in WC 4.600.40 (1)(B) above. Where the site is proposed for development necessitating site plan or plat review, application for a Tree Removal Permit shall be made as part of the site development application as specified in this subchapter.

(.03) Fees. A person applying for a Tree Removal Permit shall pay a non-refundable application fee; as established by resolution of the City Council.

- A. *By submission of an application, the applicant shall be deemed to have authorized City representatives to have access to applicant's property as may be needed to verify the information provided, to observe site conditions, and if a permit is granted, to verify that terms and conditions of the permit are followed.*

Response: Tree removal is proposed as part of the site development; therefore, a Type C tree removal permit is appropriate. As shown in Exhibit M, seven (7) trees are proposed for removal. The applicant understands that the submittal to the Type C Tree Removal application provides authority to City representatives to verify the information.

Section 4.610.00. Application Review Procedure

(.01) The permit applicant shall provide complete information as required by this subchapter in order for the City to review the application.

Response: The applicant has submitted a complete application for the City's review.

(.02) Departmental Review. All applications for Tree Removal Permits must be deemed complete by the City Planning Department before being accepted for review. When all required information has been supplied, the Planning Department will verify whether the application is complete. Upon request of either the applicant or the City, the City may conduct a field inspection or review meeting. City departments involved in the review shall submit their report and recommendations to the Planning Director who shall forward them to the appropriate reviewing authority.

Response: The applicant acknowledges the procedure for the determination of completeness and Departmental Review.

(.03) Reviewing Authority.

- B. *Type C. Where the site is proposed for development necessitating site plan review or plat approval by the Development Review Board, the Development Review Board shall be responsible for granting or denying the application for a Tree Removal Permit, and that decision may be subject to affirmance, reversal or modification by the City Council, if subsequently reviewed by the Council. For site development applications subject to a Class II administrative review process in the Coffee Creek Industrial Design Overlay District, the Planning Director shall be responsible for the granting or denial of the Tree Removal Permit application.*

Response: The site is proposed for development necessitating site plan review. The applicant has requested consolidated review with a development proposal that requires action by the DRB and City Council. The subject site is in the Coffee Creek Industrial Design Overlay District.

(.04) Notice. Before the granting of a Type C Tree Removal Permit, notice of the application shall be sent by regular mail to all owners within two hundred fifty feet (250') of the property where the trees are located as provided for in WC 4.010. The notice shall indicate where the application may be inspected and when a public hearing on the application will be held.

Response: A Type C Tree Removal Permit is requested. The applicant understands the City will mail notice to all owners within 250' of the property where the trees are located.

(.05) Denial of Tree Removal Permit. Whenever an application for a Tree Removal Permit is denied, the permit applicant shall be notified, in writing, of the reasons for denial.

Response: This is procedural direction and requires no evidence from the applicant. The applicant understands they will be notified if the tree removal permit is denied.

(.06) Grant of a Tree Removal Permit. Whenever an application for a Type B, C or D Tree Removal Permit is granted, the reviewing authority shall:

- A. *Conditions. Attach to the granting of the permit any reasonable conditions considered necessary by the reviewing authority including, but not limited to, the recording of any plan or agreement approved under this subchapter, to ensure that the intent of this Chapter will be fulfilled and to minimize damage to, encroachment on or interference with natural resources and processes within wooded areas;*
- B. *Completion of Operations. Fix a reasonable time to complete tree removal operations; and*
- C. *Security. Require the Type C permit grantee to file with the City a cash or corporate surety bond or irrevocable bank letter of credit in an amount determined necessary by the City to ensure compliance with Tree Removal Permit conditions and this Chapter.*
 - 1. *This requirement may be waived by the Planning Director if the tree removal must be completed before a plat is recorded, and the applicant has complied with WC 4.264(1) of this Code.*

Response: A Type C Tree Removal Permit is requested. The applicant understands the City may impose conditions consistent with the requirements of this provision.

Section 4.610.10. Standards For Tree Removal, Relocation Or Replacement

(.01) Except where an application is exempt, or where otherwise noted, the following standards shall govern the review of an application for a Type A, B, C or D Tree Removal Permit:

- A. *Standard for the Significant Resource Overlay Zone. The standard for tree removal in the Significant Resource Overlay Zone shall be that removal or transplanting of any tree is not inconsistent with the purposes of this Chapter.*

Response: The subject site is partially located in a Significant Resource Overlay Zone, so this standard applies; however, no tree removal is proposed in the SROZ.

- B. *Preservation and Conservation. No development application shall be denied solely because trees grow on the site. Nevertheless, tree preservation and conservation as a design principle shall be equal in concern and importance to other design principles.*

Response: The site layout, including planting of parking lot trees, has been designed to avoid removal of trees to the greatest extent possible.

- C. *Developmental Alternatives. Preservation and conservation of wooded areas and trees shall be given careful consideration when there are feasible and reasonable location alternatives and design options on-site for proposed buildings, structures or other site improvements.*

Response: Preservation and conservation of wooded areas and trees was given careful consideration in site planning and design; therefore, the area of the site within the SROZ will remain undisturbed as part of the proposed development. A vegetated stormwater facility is proposed within the SROZ Impact Area. The site layout proposed the driveway in the area with the least trees on site, while creating a connection to the existing curb cut in SW 5th Street. The location of the parking lot is located as near as possible to the uses which it will serve, while minimizing impact to the trees between the southern parking area and storage area to the north. This standard is met.

D. Land Clearing. Where the proposed activity requires land clearing, the clearing shall be limited to designated street rights-of-way and areas necessary for the construction of buildings, structures or other site improvements.

Response: Clearing and grading on the site will be limited to the extents of site improvement. Construction on the site will also be in alignment with the tree protection as shown on Sheet L5.10 of Exhibit E, and in coordination with the arborist's recommendations (Exhibit M). This standard is met.

E. Residential Development. Where the proposed activity involves residential development, residential units shall, to the extent reasonably feasible, be designed and constructed to blend into the natural setting of the landscape.

Response: The proposed development is not residential. This standard does not apply.

F. Compliance With Statutes and Ordinances. The proposed activity shall comply with all applicable statutes and ordinances.

Response: The applicant has submitted this application and narrative to show compliance with all applicable statutes and ordinances.

G. Relocation or Replacement. The proposed activity shall include necessary provisions for tree relocation or replacement, in accordance with WC 4.620.00, and the protection of those trees that are not to be removed, in accordance with WC 4.620.10.

Response: The applicant will replace removed trees, at the ratio of one mitigation tree for each tree removed. As shown in Exhibit M, seven (7) trees are proposed for removal and seven (7) trees will be planted as mitigation trees.

H. Limitation. Tree removal or transplanting shall be limited to instances where the applicant has provided completed information as required by this Chapter and the reviewing authority determines that removal or transplanting is necessary based on the criteria of this subsection.

- 1. Necessary For Construction. Where the applicant has shown to the satisfaction of the reviewing authority that removal or transplanting is necessary for the construction of a building, structure or other site improvement, and that there is no feasible and reasonable location alternative or design option on-site for a proposed building, structure or other site improvement; or a tree is located too close to existing or proposed buildings or structures, or creates unsafe vision clearance.*
- 2. Disease, Damage, or Nuisance, or Hazard. Where the tree is diseased, damaged, or in danger of falling, or presents a hazard as defined in WC 6.208, or is a nuisance as defined in WC 6.200 et seq., or creates unsafe vision clearance as defined in this Code.*

- (a) *As a condition of approval of Stage II development, filbert trees must be removed if they are no longer commercially grown or maintained.*
- 3. *Interference. Where the tree interferes with the healthy growth of other trees, existing utility service or drainage, or utility work in a previously dedicated right-of-way, and it is not feasible to preserve the tree on site.*
- 4. *Other. Where the applicant shows that tree removal or transplanting is reasonable under the circumstances.*

Response: The removal of trees at this site is necessary for the construction of a driveway access and the vegetated stormwater facilities. Tree removal is necessary for construction because there is no feasible or reasonable alternative design option for industrial use; due to site constraints, including the existing driveway approach on SW 5th Street, there is no alternative design approach that could increase the preservation of on-site trees while meeting user requirements. This standard is met.

I. Additional Standards for Type C Permits.

- 1. *Tree survey. For all site development applications reviewed under the provisions of Chapter 4 Planning and Zoning, the developer shall provide a Tree Survey before site development as required by WC 4.610.40, and provide a Tree Maintenance and Protection plan, unless specifically exempted by the Planning Director or DRB, prior to initiating site development.*

Response: A preliminary arborist report, include a tree inventory and tree maintenance and protection plan is included as Exhibit M. This standard is met.

- 2. *Platted Subdivisions. The recording of a final subdivision plat whose preliminary plat has been reviewed and approved after the effective date of Ordinance 464 by the City and that conforms with this subchapter shall include a Tree Survey and Maintenance and Protection Plan, as required by this subchapter, along with all other conditions of approval.*

Response: No subdivision is proposed. This standard is not applicable.

- 3. *Utilities. The City Engineer shall cause utilities to be located and placed wherever reasonably possible to avoid adverse environmental consequences given the circumstances of existing locations, costs of placement and extensions, the public welfare, terrain, and preservation of natural resources. Mitigation and/or replacement of any removed trees shall be in accordance with the standards of this subchapter.*

Response: No public utilities are proposed. For the south parking area and proposed driveway area, larger events the exceed the infiltration capacity of the soil will be routed to have drain path to the piped storm drain system under the SW 5th Street extension that drains into a natural drainageway on the south side of SW 5th Street. The connection point to the natural drainageway on the south side of SW 5th Street will be finalized during permitting, in coordination with City staff.

- J. Exemption. Type D permit applications shall be exempt from review under standards D, E, H and I of this subsection.*

Response: A Type C Tree Removal Permit, not Type D, is requested. This standard is not applicable.

Section 4.610.40. - Type C Permit.

(.01) *Approval to remove any trees on property as part of a site development application may be granted in a Type C permit. A Type C permit application shall be reviewed by the standards of this subchapter and all applicable review criteria of Chapter 4. Application of the standards of this section shall not result in a reduction of square footage or loss of density, but may require an applicant to modify plans to allow for buildings of greater height. If an applicant proposes to remove trees and submits a landscaping plan as part of a site development application, an application for a Tree Removal Permit shall be included. The Tree Removal Permit application will be reviewed in the Stage II development review process. The DRB shall review all Type C permits, with the exception of Class II development review applications located within the Coffee Creek Industrial Design Overlay District, where the Planning Director shall have review authority. Any plan changes made that affect trees after Stage II review of a development application shall be subject to review by the original approval authority. Where mitigation is required for tree removal, such mitigation may be considered as part of the landscaping requirements as set forth in this Chapter. Tree removal shall not commence until approval of the required Stage II application and the expiration of the appeal period following that decision. If a decision approving a Type C permit is appealed, no trees shall be removed until the appeal has been settled.*

Response: This proposal seeks tree removal to accommodate site development; therefore, a Type C permit is required. The site is not located in the Coffee Creek Industrial Design Overlay District; therefore, this Type C request is subject to Development Review Board review.

(.02) *The applicant must provide ten copies of a Tree Maintenance and Protection Plan completed by an arborist that contains the following information:*

- A. *A plan, including a topographical survey bearing the stamp and signature of a qualified, registered professional containing all the following information:*
 1. *Property Dimensions. The shape and dimensions of the property, and the location of any existing and proposed structure or improvement.*
 2. *Tree survey. The survey must include:*
 - a. *An accurate drawing of the site based on accurate survey techniques at a minimum scale of one inch equals 100 feet and which provides a) the location of all trees having six inches or greater d.b.h. likely to be impacted, b) the spread of canopy of those trees, (c) the common and botanical name of those trees, and d) the approximate location and name of any other trees on the property.*
 - b. *A description of the health and condition of all trees likely to be impacted on the site property. In addition, for trees in a present or proposed public street or road right-of-way that are described as unhealthy, the description shall include recommended actions to restore such trees to full health. Trees proposed to remain, to be transplanted or to be removed shall be so designated. All trees to remain on the site are to be designated with metal tags that are to remain in place throughout the development. Those tags shall be numbered, with the numbers keyed to the tree survey map that is provided with the application.*
 - c. *Where a stand of 20 or more contiguous trees exist on a site and the applicant does not propose to remove any of those trees, the required tree survey may be simplified to accurately show only the perimeter area of that stand of trees, including its drip line. Only those trees on the perimeter of the stand shall be tagged, as provided in "b," above.*

- d. *All Oregon white oaks, native yews, and any species listed by either the state or federal government as rare or endangered shall be shown in the tree survey.*
3. *Tree Protection. A statement describing how trees intended to remain will be protected during development, and where protective barriers are necessary, that they will be erected before work starts. Barriers shall be sufficiently substantial to withstand nearby construction activities. Plastic tape or similar forms of markers do not constitute "barriers."*
4. *Easements and Setbacks. Location and dimension of existing and proposed easements, as well as all setbacks required by existing zoning requirements.*
5. *Grade Changes. Designation of grade changes proposed for the property that may impact trees.*
6. *Cost of Replacement. A cost estimate for the proposed tree replacement program with a detailed explanation including the number, size and species.*
7. *Tree Identification. A statement that all trees being retained will be identified by numbered metal tags, as specified in subsection "A," above in addition to clear identification on construction documents.*

Response: A plan prepared by the arborist is provided in Exhibit M. This standard is met.

Section 4.620.00. Tree Relocation, Mitigation, Or Replacement

(.01) Requirement Established. A Type B or C Tree Removal Permit grantee shall replace or relocate each removed tree having six inches or greater d.b.h. within one year of removal.

Response: Seven (7) trees with a 6" or greater d.b.h. are proposed for removal as part of the site improvements. Seven (7) mitigation trees are proposed to be planted as part of the site improvements. This standard is met.

(.02) Basis For Determining Replacement. The permit grantee shall replace removed trees on a basis of one tree replanted for each tree removed. All replacement trees must measure two inches or more in diameter. Alternatively, the Planning Director or Development Review Board may require the permit grantee to replace removed trees on a per caliper inch basis, based on a finding that the large size of the trees being removed justifies an increase in the replacement trees required. Except, however, that the Planning Director or Development Review Board may allow the use of replacement Oregon white oaks and other uniquely valuable trees with a smaller diameter.

Response: Trees are proposed for removal as part of the site improvements. Seven (7) trees with a 6" or greater d.b.h. are proposed for removal as part of the site improvements. Seven (7) mitigation trees are proposed to be planted as part of the site improvements. This standard is met.

(.03) Replacement Tree Requirements. A mitigation or replacement tree plan shall be reviewed by the City prior to planting and according to the standards of this subsection.

- A. *Replacement trees shall have shade potential or other characteristics comparable to the removed trees, shall be appropriately chosen for the site from an approved tree species list supplied by the City, and shall be state Department of Agriculture Nursery Grade No. 1 or better.*
- B. *Replacement trees must be staked, fertilized and mulched, and shall be guaranteed by the permit grantee or the grantee's successors-in-interest for two years after the planting date.*
- C. *A "guaranteed" tree that dies or becomes diseased during that time shall be replaced.*
- D. *Diversity of tree species shall be encouraged where trees will be replaced, and diversity of species shall also be maintained where essential to preserving a wooded area or habitat.*

Response: Replacement trees will be carefully selected to provide benefits similar to those trees proposed for removal. Replacement trees will be staked, fertilized and mulched and guaranteed for two years after the planting date. A guaranteed tree that dies during the warranty period will be replaced. The replacement trees have been selected to maintain a diversity of trees on site. This standard is met.

(.04) *All trees to be planted shall consist of nursery stock that meets requirements of the American Association of Nurserymen (AAN) American Standards for Nursery Stock (ANSI Z60.1) for top grade.*

Response: All trees to be planted will meet this standard as noted on Sheet L0.01 of Exhibit E. This standard is met.

(.05) *Replacement Tree Location.*

- A. *City Review Required. The City shall review tree relocation or replacement plans in order to provide optimum enhancement, preservation and protection of wooded areas. To the extent feasible and desirable, trees shall be relocated or replaced on-site and within the same general area as trees removed.*
- B. *Relocation or Replacement Off-Site. When it is not feasible or desirable to relocate or replace trees on-site, relocation or replacement may be made at another location approved by the City.*

Response: The locations of tree plantings have been carefully considered to provide enhancement benefits. No off-site plantings are proposed. This standard is met.

(.06) *City Tree Fund. Where it is not feasible to relocate or replace trees on site or at another approved location in the City, the Tree Removal Permit grantee shall pay into the City Tree Fund, which fund is hereby created, an amount of money approximately the value as defined by this subchapter, of the replacement trees that would otherwise be required by this subchapter. The City shall use the City Tree Fund for the purpose of producing, maintaining and preserving wooded areas and heritage trees, and for planting trees within the City.*

- A. *The City Tree Fund shall be used to offer trees at low cost on a first-come, first-serve basis to any Type A Permit grantee who requests a tree and registers with the City Tree Fund.*
- B. *In addition, and as funds allow, the City Tree Fund shall provide educational materials to assist with tree planting, mitigation, and relocation.*

Response: Replacements trees will be planted on site. This standard is not applicable.

(.07) *Exception. Tree replacement may not be required for applicants in circumstances where the Director determines that there is good cause to not so require. Good cause shall be based on a consideration of preservation of natural resources, including preservation of mature trees and diversity of ages of trees. Other criteria shall include consideration of terrain, difficulty of replacement and impact on adjacent property.*

Response: The applicant is not seeking an exception under this provision. This standard is not applicable.

Section 4.620.10. Tree Protection During Construction

(.01) *Where tree protection is required by a condition of development under Chapter 4 or by a Tree Maintenance and Protection Plan approved under this subchapter, the following standards apply:*

- A. *All trees required to be protected must be clearly labeled as such.*
- B. *Placing Construction Materials Near Tree. No person may conduct any construction activity likely to be injurious to a tree designated to remain, including, but not limited to, placing solvents, building material, construction equipment, or depositing soil, or placing*

irrigated landscaping, within the drip line, unless a plan for such construction activity has been approved by the Planning Director or Development Review Board based upon the recommendations of an arborist.

- C. *Attachments to Trees During Construction. Notwithstanding the requirement of WC 4.620.10(1)(A), no person shall attach any device or wire to any protected tree unless needed for tree protection.*
- D. *Protective Barrier. Before development, land clearing, filling or any land alteration for which a Tree Removal Permit is required, the developer shall erect and maintain suitable barriers as identified by an arborist to protect remaining trees. Protective barriers shall remain in place until the City authorizes their removal or issues a final certificate of occupancy, whichever occurs first. Barriers shall be sufficiently substantial to withstand nearby construction activities.*
Plastic tape or similar forms of markers do not constitute "barriers." The most appropriate and protective barrier shall be utilized. Barriers are required for all trees designated to remain, except in the following cases:
 - 1. *Right-of-Ways and Easements. Street right-of-way and utility easements may be cordoned by placing stakes a minimum of fifty (50) feet apart and tying ribbon, plastic tape, rope, etc., from stake to stake along the outside perimeters of areas to be cleared.*
 - 2. *Any property area separate from the construction or land clearing area onto which no equipment will venture may also be cordoned off as described in paragraph (D) of this subsection, or by other reasonable means as approved by the reviewing authority.*

Response: Tree protection measures are specified in the L-Series sheets of Exhibit E and the arborist report (Exhibit M), and will be implemented in the construction plans for the site.

Section 4.620.20. Maintenance And Protection Standards

(.01) The following standards apply to all activities affecting trees, including, but not limited to, tree protection as required by a condition of approval on a site development application brought under this Chapter or as required by an approved Tree Maintenance and Protection Plan.

- A. *Pruning activities shall be guided by the most recent version of the ANSI 300 Standards for Tree, Shrub, and Other Woody Plant Maintenance. Information on these standards shall be available upon request from the Planning Department.*
- B. *Topping is prohibited.*
 - 1. *Exception from this section may be granted under a Tree Removal Permit if necessary for utility work or public safety.*

Response: The applicant will perform maintenance and protection practices according to ANSI 300 standards. This standard will be met.

Section 4.630.00. Appeal

(.01) The City shall not issue a Tree Removal Permit until approval has been granted by either the Planning Director or the DRB. Any applicant denied a Type A or B permit may appeal the decision as provided for in review of Class I Development Applications, or Class II Development Applications, whichever is applicable. Decisions by the Planning Director may be appealed to the DRB as provided in WC 4.022. Decisions by the DRB may be appealed to the City Council as provided in WC 4.022.

Response: The applicant acknowledges this process and their right to appeal a denied permit.

(.02) The City shall not issue a Tree Removal Permit approved by the Development Review Board until fifteen (15) calendar days have passed following the approval. The grant or denial of a Tree Removal Permit may be appealed to the City Council in the same manner as provided for in WC 4.022. An appeal must be filed in writing, within the fifteen (15) calendar day period following the decision being appealed. The timely filing of an appeal shall have the effect of suspending the issuance of a permit pending the outcome of the appeal. The City Council, upon review, may affirm, reverse or modify the decision rendered by the Development Review Board based upon the same standards of review specified for the DRB in the Wilsonville Code.

Response: The applicant acknowledges there is a 15-day appeal period between granting or denying a Tree Removal permit and issuance for an approved permit.

Section 4.630.10. Display Of Permit; Inspection

The Tree Removal Permit grantee shall conspicuously display the permit on-site. The permit grantee shall display the permit continuously while trees are being removed or replaced or while activities authorized under the permit are performed. The permit grantee shall allow City representatives to enter and inspect the premises at any reasonable time, and failure to allow inspection shall constitute a violation of this subchapter.

Response: The permit will be conspicuously displayed on the job site. This standard will be met.

Section 4.630.20. Variance For Hardship

Any person may apply for a variance of this subchapter as provided for in Section 4.196 of this Chapter.

Response: A variance is not requested.

Section 4.630.30. Severability

If any part of this ordinance is found by a court of competent jurisdiction to be invalid, that part shall be severable and the remainder of this ordinance shall not be affected.

Response: This provision requires no evidence from the applicant.

Section 4.640.00. Violation; Enforcement

(.01) The cutting, damaging, or removal of any individual tree without a permit as required by this ordinance constitutes a violation punishable as a separate infraction under WC 1.013. In addition, each violation of a condition or a violation of any requirement of this Chapter shall constitute a separate infraction.

Response: The tree removal plan shall be followed. This standard will be met.

(.02) Retroactive Permit. A person who removes a tree without obtaining a Type A or Type B permit may apply retroactively for a permit. In addition to all application requirements of this Chapter, the person must be able to demonstrate compliance with all requirements of this subchapter, in addition to paying a triple permit fee and a penalty per tree in an amount established by resolution of City Council. Mitigation requirements of this subchapter apply to all retroactive permits.

Response: This application is not a request for a retroactive tree removal permit. This provision requires no evidence from the applicant.

(.03) Nuisance Abatement. Removal of a tree in violation of this Chapter is a nuisance and may be abated as provided in Sections 6.230 to 6.244, 6.250, and 6.260 of the Wilsonville Code.

Response: It is not the applicant's intention to remove any tree in violation of this Chapter. This provision requires no evidence from the applicant.

(.04) Withholding Certificate of Occupancy. The City Building Official has the authority to issue a stop-work order, withhold approval of a final plat, or withhold issuance of a certificate of occupancy, permits or inspections until the provisions of this Chapter, including any conditions attached to a Tree Removal Permit, have been fully met.

Response: This provision requires no evidence from the applicant.

(.05) Fines. Fines for a violation shall be imposed according to WC 1.012.

Response: This provision requires no evidence from the applicant.

(.06) Mitigation. The City shall require the property owner to replace illegally removed or damaged trees. The City may also require a combination of payment and tree replacement.

- A. *The City shall notify the property owner in writing that a violation has occurred and mitigation is required. Within thirty (30) days of the date of mailing of the notice, the property owner shall provide a mitigation plan to the City. The plan shall provide for replacement of a tree of similar species and size taking into account the suitability of the site and nursery stock availability.*
- B. *Replacement will be on an inch-for-inch basis computed by adding the total diameter measured at d.b.h. in inches of the illegally removed or damaged trees. The City may use any reasonable means to estimate the tree loss if destruction of the illegally removed or damaged trees prevents exact measurement. All replaced trees must be a minimum two-inch (2") caliper. If the mitigation requirements cannot be completed on the property, the City may require completion at another approved location. Alternatively, the City may require payment into the City Tree Fund of the value of the removed tree as established by the Planning Department.*

Response: This application is for a Type C Tree Removal permit associated with new development. It is not in response to a notice of violation or other enforcement action. The above provisions are not applicable.

Section 4.640.10. Alternative Enforcement

(.01) In the event that a person commits more than one violation of WC 4.600.30 to WC 4.630.00, the following alternative sentence may be imposed:

- A. *If a person has gained money or property through the commission of an offense under this section, then upon conviction thereof, the court, in lieu of imposing a fine, may sentence the person to pay an amount, fixed by the court, not to exceed double the amount of the gain from the commission of the offense.*
- B. *"Gain" is defined as the amount of money or value of property derived from the commission of the violation, less the amount of money or value of property seized by or surrendered to the City. "Value" shall be the greater of the market value or replacement cost as determined by a licensed professional in the tree, nursery, or landscape field.*
- C. *Any fines collected by the City under this section shall accrue to the City Tree Fund.*

Response: Understood. It is not the applicant's intention to remove any tree in violation of this Chapter. This provision requires no evidence from the applicant.

Section 4.640.20. Responsibility For Enforcement.

Compliance with this Chapter shall be enforced by the City Attorney, the City Attorney's designee, and Clackamas County or Washington County law enforcement officers.

Response: This provision provides procedural guidance for enforcement actions and requires no evidence from the applicant.



V. CONCLUSION

Based on the information presented and discussed in this narrative and the attached supporting plans and documentation, this application meets applicable standards necessary for land use approval. The proposed development complies with all applicable standards of the Wilsonville Planning and Land Development Ordinance. The applicant respectfully requests approval by the City.

OREPAC SITE Aerial Map

Wilsonville, Oregon

LEGEND

-  OrePac Site
-  Tax Lots

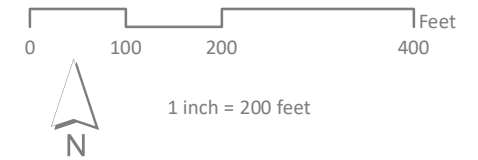
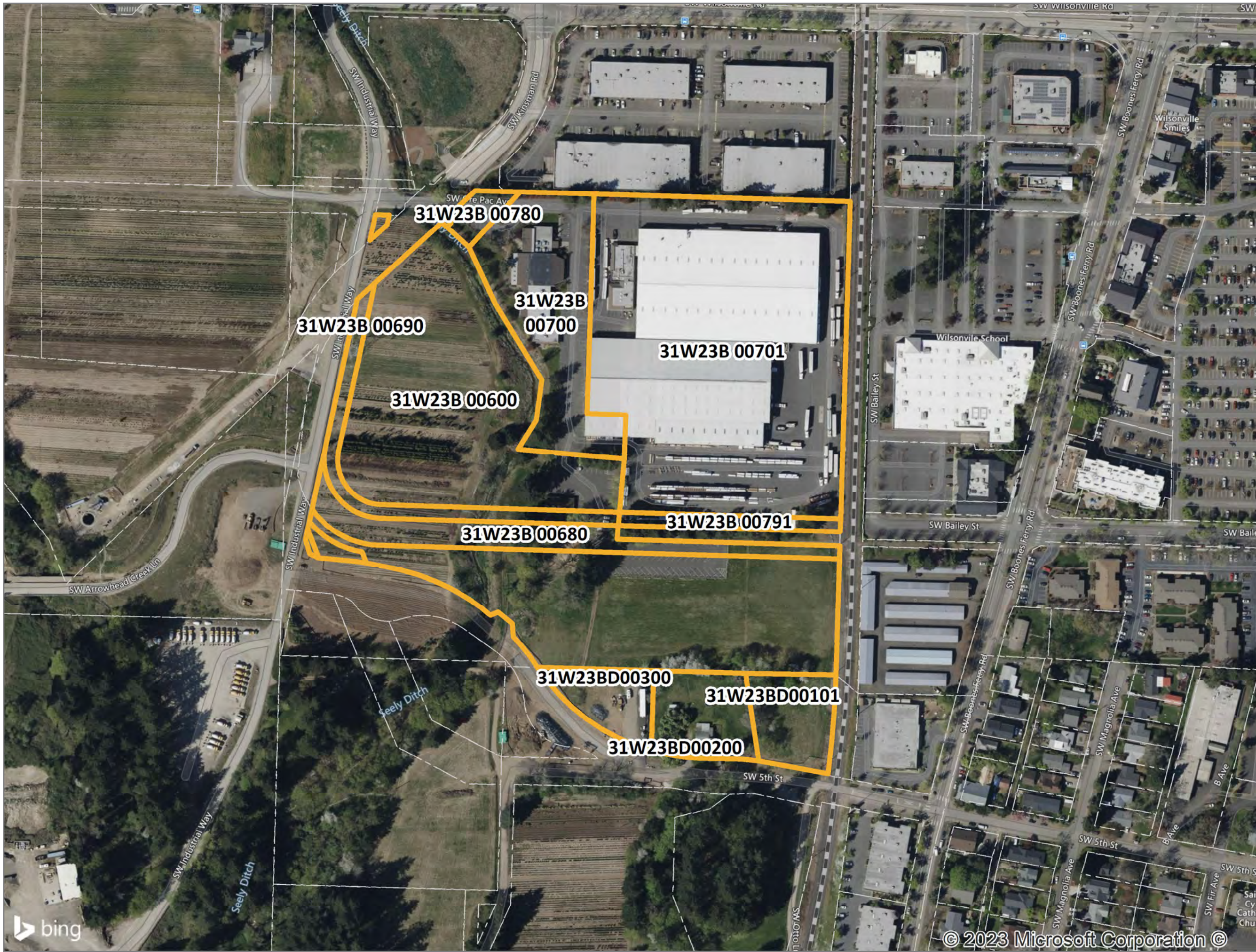

SOURCE DATA: Metro RLS Lite Base Data, Jun 2023
GEOGRAPHIC PROJECTION: NAD 83 HARN, Oregon North Lambert Conformal Conic

Date: 7/5/2023
File: Site_Aerial
Map Created By: SH
Project No: 2220061.00



MACKENZIE.

P 503.224.9560 • F 503.228.1285 • W MCKNZE.COM
RiverEast Center, 1515 SE Water Avenue, #100, Portland, OR 97214
Portland, Oregon • Vancouver, Washington • Seattle, Washington

OrePac Wilsonville Zoning Map

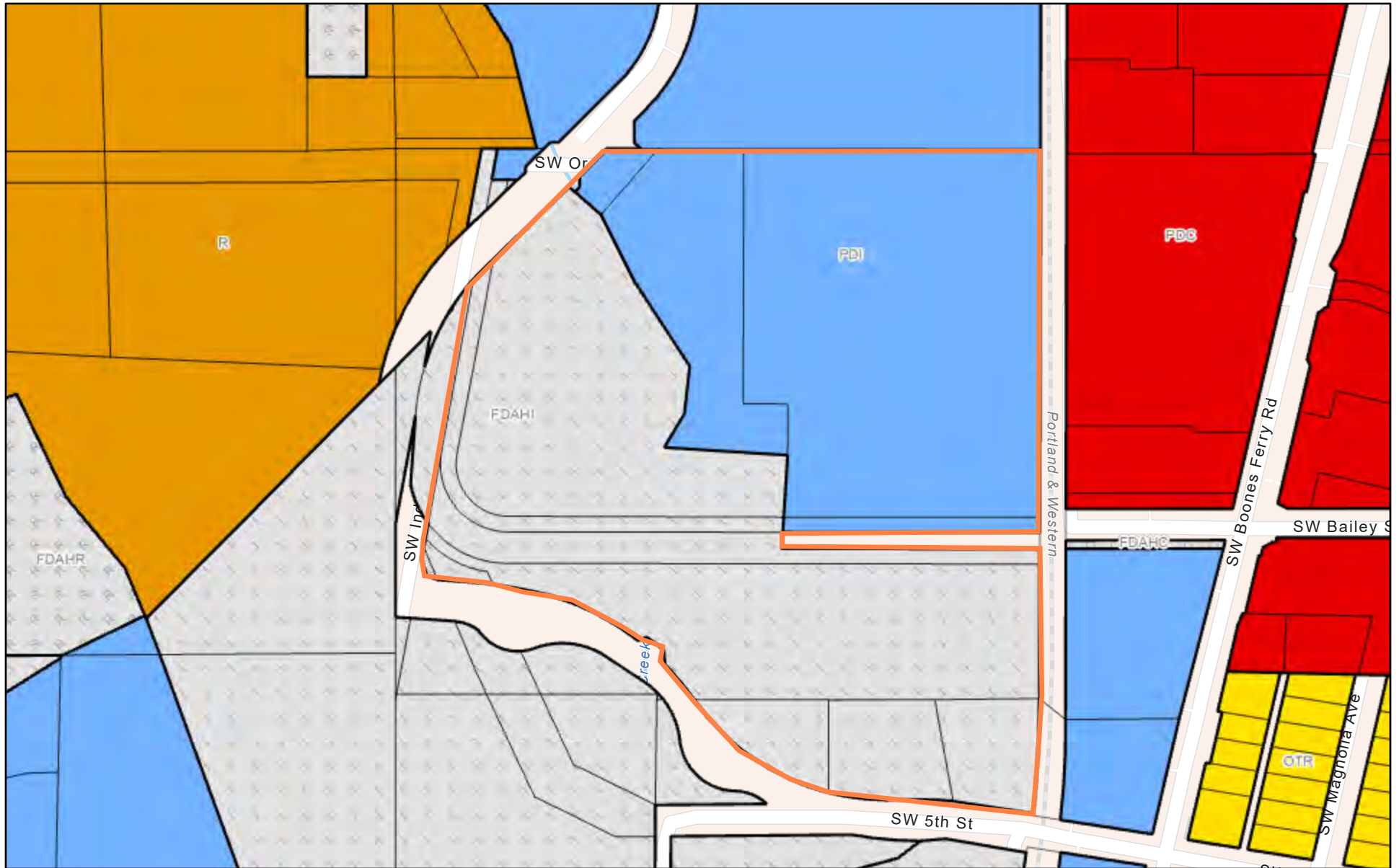

July 5, 2023

- | | | |
|--------------|--------------------------------|---|
| RLIS Taxlots | Planned Development Commercial | Future Development Agricultural Holding Commercial |
| Zone | Planned Development Industrial | Future Development Agricultural Holding Industrial |
| OTR | Residential | Future Development Agricultural Holding Residential |
| | Approximate Site Boundary | |

1:4,514

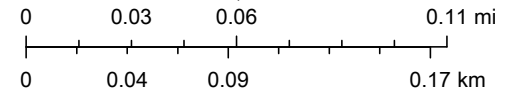

Esri Community Maps Contributors, Oregon Metro, Oregon State Parks, State of Oregon GEO, © OpenStreetMap, Microsoft, Esri, HERE, Garmin,

RECEIVED: _____

ACCEPTED FOR FILING: _____

SURVEY NUMBER: _____

Record of Survey

PROPERTY LINE ADJUSTMENT
WITHIN THE THOMAS BAILEY DLC 45
IN THE N.W. 1/4 OF SECTION 23, T.3S., R.1W., W.M.
CITY OF WILSONVILLE, CLACKAMAS COUNTY, OREGON,

JULY 8, 2024

FOR: INLAND PACIFIC PROPERTIES, LLLC

NARRATIVE:

THE BASIS OF BEARINGS IS THE WEST LINE OF THE THOMAS BAILEY DLC 45 PER SN 2017-241. THIS SURVEY WAS PERFORMED TO SET OUT THE BOUNDARIES OF A PROPERTY LINE ADJUSTMENT PER CITY OF WILSONVILLE PLANNING FILE NO: DB24-0001 OREPAC SITE IMPROVEMENTS.

MONUMENTS WERE HELD ALONG THE CENTERLINES OF 5TH STREET AND KINSMAN ROAD, ALONG WITH CONTROL POINTS SHOWN ON SN 2017-241 AND 2024-004 TO ESTABLISH SAID ROADS AND RIGHT OF WAY LINES. DATA WAS USED PER SAID SURVEYS, FOR THE POSITION OF MONUMENTS DESTROYED BY CONSTRUCTION.

THE SOUTH AND WEST LINES OF PARTITION PLAT NO. 1990-92 WAS ESTABLISHED BY HOLDING PLAT DATA AND THE THREE MONUMENTS ALONG SAID LINES AS SHOWN.

DATA WAS HELD PER SN 2017-241 TO ESTABLISH THE CENTERLINE AND RIGHT OF WAY LINE OF OREGON ELECTRIC RAILROAD.

ALL OF THE PROPERTIES BOUNDED BY 5TH STREET, INDUSTRIAL WAY, KINSMAN STREET, PARTITION PLAT NO. 1990-92 AND THE RAILROAD ARE OWNED BY THE SAME ENTITY. THE LINE COMMON TO PARCEL 1 (D1) AND (D2) HAVE THE SAME DIRECTION CALL (SOUTH 10'16" EAST). THE NORTH CORNER OF THE WEST LINE OF PARCEL 1 (D1) (DESCRIBED FROM THE EAST) AND EAST LINE OF (D2) (DESCRIBED FROM THE WEST) ARE IN CONFLICT. FOR THE PURPOSE OF COMPUTING AREAS FOR THIS ADJUSTMENT I HAVE HELD THE MONUMENTS AND DATA FROM THE 1990 SURVEY SN 3258 TO ESTABLISH THE LINE. FOR THE NORTH LINE I HELD THE IRON PIPE NEAR THE DLC LINE AND THE IR NEAR THE RAILROAD RIGHT OF WAY PER SN 10773 AND THE IR NEAR THE NW CORNER OF (D2). THE NE CORNER OF (D2) WAS ESTABLISHED AT DEED DISTANCE (203.30') PER THE DEED AND SN 3258. THE EAST LINE OF (D2) WAS ESTABLISHED BY HOLDING THE RRS IN 5TH STREET PER SN 3258.

THE NEW PROPERTY LINE WAS SET OUT AT THE DIRECTION OF THE CLIENT AS SHOWN. THE ADJUSTMENT DEED IS RECORDED AS DOCUMENT NO. _____, CLACKAMAS COUNTY RECORDS.

APPROVAL:

CITY OF WILSONVILLE PLANNING FILE NO:
DB24-0001 OREPAC SITE IMPROVEMENTS.

BY: _____ DATE: _____

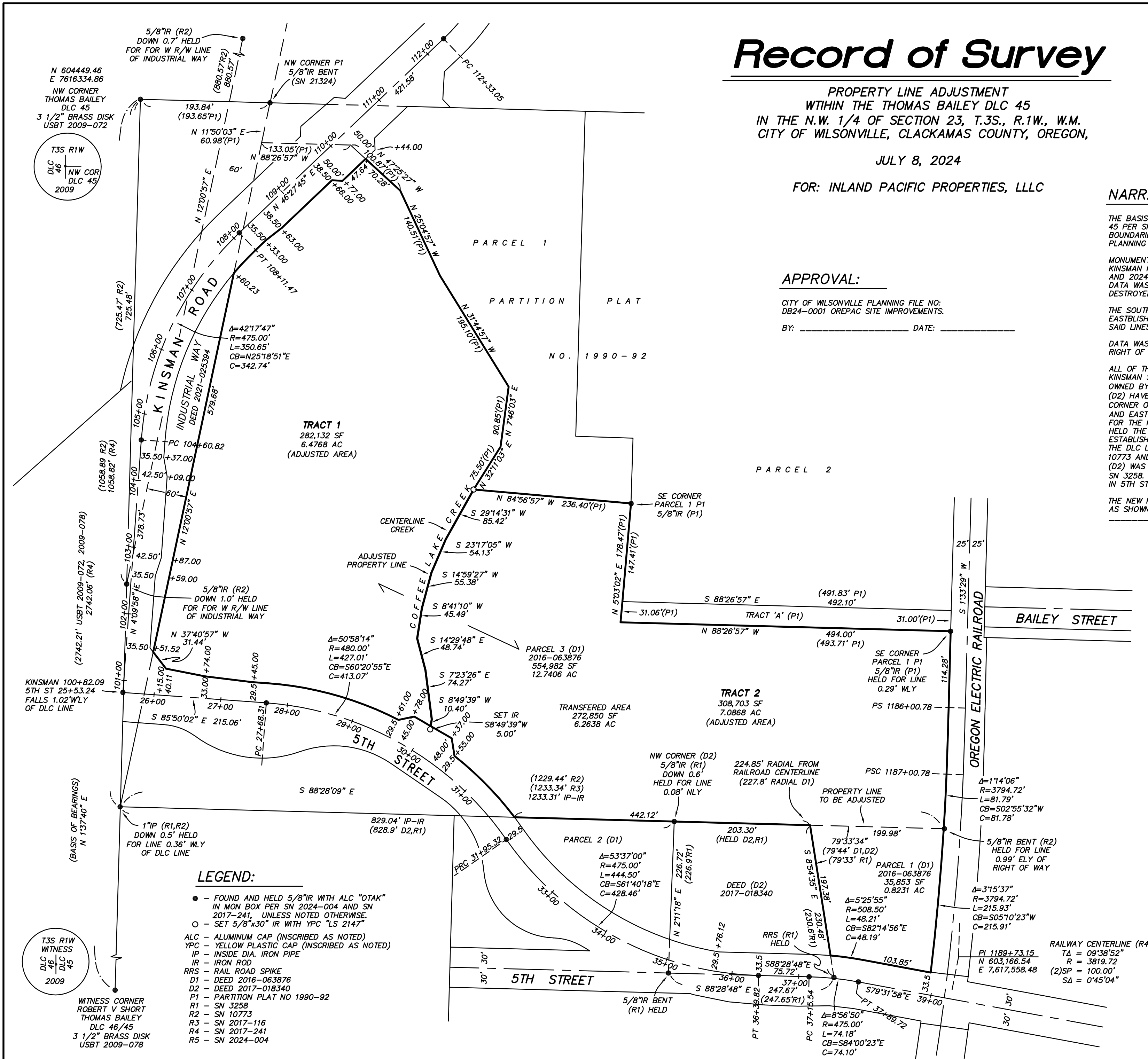

LEGEND:

- - FOUND AND HELD 5/8" IR WITH ALC "OTAK" IN MON BOX PER SN 2024-004 AND SN 2017-241, UNLESS NOTED OTHERWISE.
- - SET 5/8"x30" IR WITH YPC "LS 2147"
- ALC - ALUMINUM CAP (INSCRIBED AS NOTED)
- YPC - YELLOW PLASTIC CAP (INSCRIBED AS NOTED)
- IP - INSIDE DIA. IRON PIPE
- IR - IRON ROD
- RRS - RAIL ROAD SPIKE
- D1 - DEED 2016-063876
- D2 - DEED 2017-018340
- P1 - PARTITION PLAT NO 1990-92
- R1 - SN 3258
- R2 - SN 10773
- R3 - SN 2017-116
- R4 - SN 2017-241
- R5 - SN 2024-004

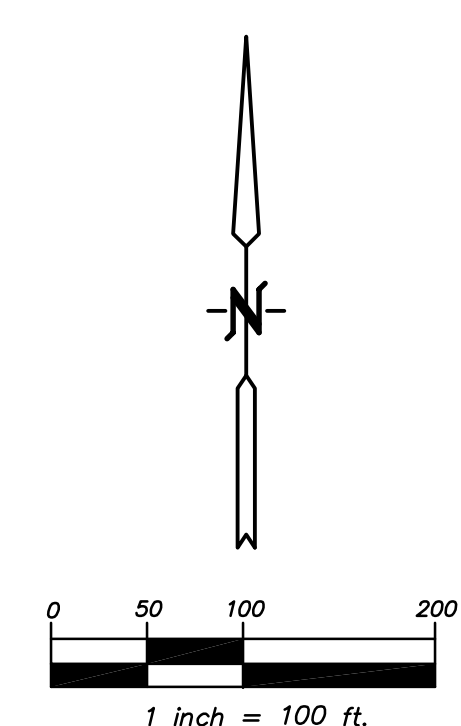

REGISTERED
PROFESSIONAL
LAND SURVEYOR

Kenneth D. Griffin

OREGON
JULY 26, 1985
KENNETH D. GRIFFIN
2147

RENEWS: 6/30/25
0864 OREPAC PLA

GRIFFIN LAND SURVEYING INC.
6107 SW MURRAY BLVD. #409
BEAVERTON, OR. 97008
PHONE: (503)201-3116

N 604449.46
E 7616334.86
NW CORNER
THOMAS BAILEY
DLC 45
3 1/2" BRASS DISK
USBT 2009-072

T3S R1W
DLC 46
NW COR
DLC 45
2009

T3S R1W
DLC 46
DLC 45
2009

WITNESS CORNER
ROBERT V SHORT
THOMAS BAILEY
DLC 46/45
3 1/2" BRASS DISK
USBT 2009-078

OrePac South Lot

Wilsonville, OR

Owner: Inland Pacific Properties, LLC

J.O. SGL 17-023

December 2023
Revised July 2024

PRELIMINARY STORMWATER CALCULATIONS



EXPIRES: 6/30/

SISUL ENGINEERING

A Division of Sisul Enterprises, Inc.

**375 Portland Avenue
Gladstone, OR 97027**

PHONE: (503) 657-0188

FAX: (503) 657-5779

Narrative:

The site has an address of 30445 SW Boones Ferry Road, Wilsonville, Oregon, according to the Clackamas County GIS mapping system, although the site is physically located north of the new SW 5th Street extension and west of the railroad tracks. There are two parking areas on site, that were apparently constructed without permit and these areas will be legalized through this application. In addition, a new driveway access from the OrePac facilities to the SW 5th Street extension is proposed to be constructed.

The purpose of this report is to determine the size of the rain gardens and water quality pond that are proposed to provide water quality and detention for the previously constructed parking area and the proposed driveway. (The sizing was designed based on the BMP sizing tool, as provided by Clackamas County WES and utilized by the City of Wilsonville.)

BMP Sizing Tool:

Infiltration rates were determined by Redmond Geotechnical Services (see attached report at the end of these calculations)..

Soil Type:

This site has the following soil types as identified by (Web Soil Survey). See attached infiltration report for further information.

53A - Latourell Loam, 0 to 3 percent slops – Hydrologic Group ‘B’

53B - Latourell Loam, 3 to 8 percent slops – Hydrologic Group ‘B’

71A - Quatama Loam, 0 to 3 percent slopes – Hydrologic Group ‘C’

The primary soil type for the site is the Latourell Loam, with the Quatama Loam soil being only a very small portion of the site in the northeast corner of the site. The hydrologic group B soil matches well with the measured infiltration rates of by the geotechnical engineer.

Areas:

South Parking Lot – 27,000 SF - nearly all impervious

Proposed Drive Access – 40,000 SF – all impervious

East portion of the “L” shaped parking area – 8,450 SF – all impervious

West portion of the “L” shaped parking area – 7,400 SF – all impervious

Site Conditions & Design Values

Infiltration Analysis:

The measured infiltration rates at 3 separate infiltration test holes on the site ranged between one and two inches/hour. Based on a Factor of Safety of 2, infiltration rates of 0.5 to 1 inch were determined to be most appropriate for design. We note this corresponds with the B3 Soil type in the BMP tool analysis.

Design Factors:

Infiltration Rain Gardens and Infiltrator systems proposed to be used are sized based on the WES BMP tool sizing analysis.

For the south parking area and proposed driveway area larger events the exceed the infiltration capacity of the soil will be routed to have drain path to the piped storm drain system under the SW 5th Street extension that drains into a natural drainageway on the south side of SW 5th Street.

For the “L” shaped parking area, larger events that exceed the infiltration capacity of the soil will be routed into the established drainage routes that drains both halves of the “L” parking area towards, Coffee Lake Creek (Seeley Ditch), north of the old barn.

BMP Results:

Post Developed: Existing South Parking Lot Area

The existing parking area will have approximately 27,000 square feet of impervious area. Using the BMP Tool, this results in a minimum rain garden size of 4,860 square feet. At this time 5,000 SF of rain garden is proposed, but adjustment to the parking area and thus rain garden will be refined with the permit drawing application, after land use approval.

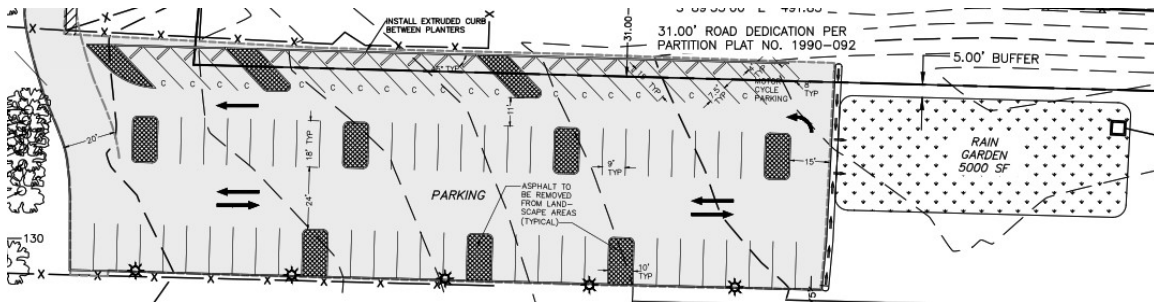

WES BMP Sizing Report

Project Information

Project Name	OrePac - South Lot Improvements - Parking area
Project Type	Addition
Location	
Stormwater Management Area	5000
Project Applicant	
Jurisdiction	OutofDistrict

Drainage Management Area

Name	Area (sq-ft)	Pre-Project Cover	Post-Project Cover	DMA Soil Type	BMP
DMA -Driveway	27,000	Grass	ConventionalConcrete	B	North Rain Garden

LID Facility Sizing Details

LID ID	Design Criteria	BMP Type	Facility Soil Type	Minimum Area (sq-ft)	Planned Areas (sq-ft)	Orifice Diameter (in)
North Rain Garden	FlowControlAndTreatment	Rain Garden - Infiltration	B3	4,860.0	5,000.0	0.0

Pond Sizing Details

1. FCWQT = Flow control and water quality treatment, WQT = Water quality treatment only
2. Depth is measured from the bottom of the facility and includes the three feet of media (drain rock, separation layer and growing media).
3. Maximum volume of the facility. Includes the volume occupied by the media at the bottom of the facility.
4. Maximum water storage volume of the facility. Includes water storage in the three feet of soil media assuming a 40 percent porosity.

Post Developed: Proposed Driveway Access from SW 5th

The proposed new driveway access to serve the OrePac site from SW 5th Street will have approximately 40,000 square feet of impervious area. Using the BMP Tool, this results in a minimum rain garden size of 7,200 square feet. At this time 7,200 SF of rain garden is proposed, but adjustment to the driveway area and thus rain garden will be refined with the permit drawing application, after land use approval.

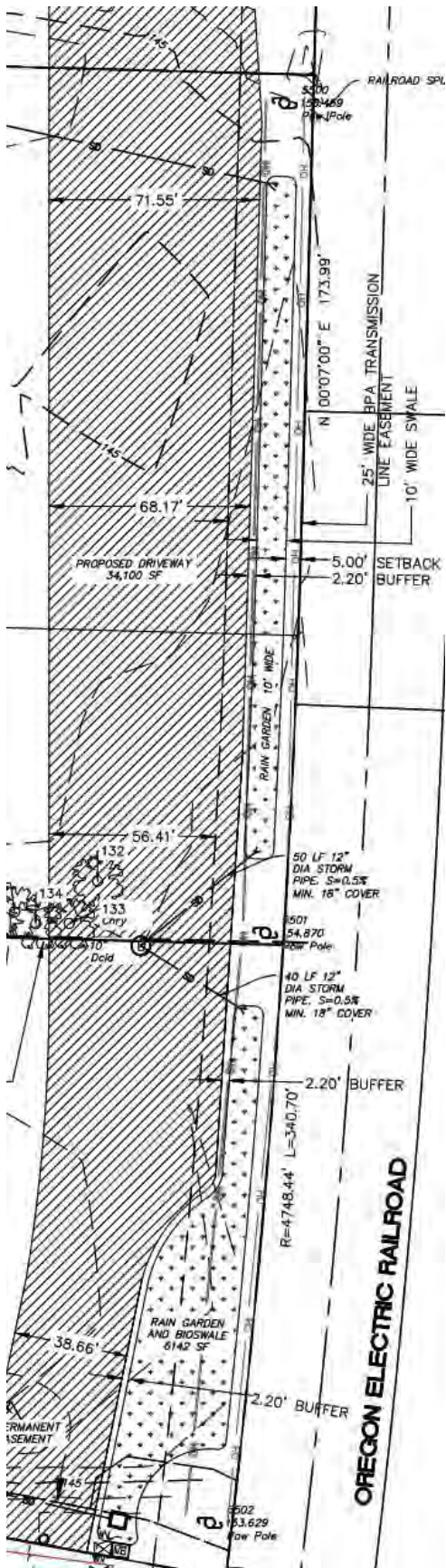

WES BMP Sizing Report

Project Information

Project Name	OrePac - South Lot Improvements - New Driveway Access
Project Type	Addition
Location	
Stormwater Management Area	7230
Project Applicant	
Jurisdiction	OutofDistrict

Drainage Management Area

Name	Area (sq-ft)	Pre-Project Cover	Post-Project Cover	DMA Soil Type	BMP
DMA -Driveway	34,100	Grass	ConventionalConcrete	B	East Rain Garden

LID Facility Sizing Details

LID ID	Design Criteria	BMP Type	Facility Soil Type	Minimum Area (sq-ft)	Planned Areas (sq-ft)	Orifice Diameter (in)
East Rain Garden	FlowControlAndTreatment	Rain Garden - Infiltration	B3	6,138.0	7,230.0	0.0

Pond Sizing Details

1. FCWQT = Flow control and water quality treatment, WQT = Water quality treatment only
2. Depth is measured from the bottom of the facility and includes the three feet of media (drain rock, separation layer and growing media).
3. Maximum volume of the facility. Includes the volume occupied by the media at the bottom of the facility.
4. Maximum water storage volume of the facility. Includes water storage in the three feet of soil media assuming a 40 percent porosity.

Post Developed: Existing East Portion Parking Lot Area

The existing parking area will have approximately 8,450 square feet of impervious area. Using the BMP Tool, this results in a minimum rain garden size of 1,521 square feet. At this time 1,600 SF of rain garden is proposed, but adjustment to the parking area and thus rain garden will be refined with the permit drawing application, after land use approval.

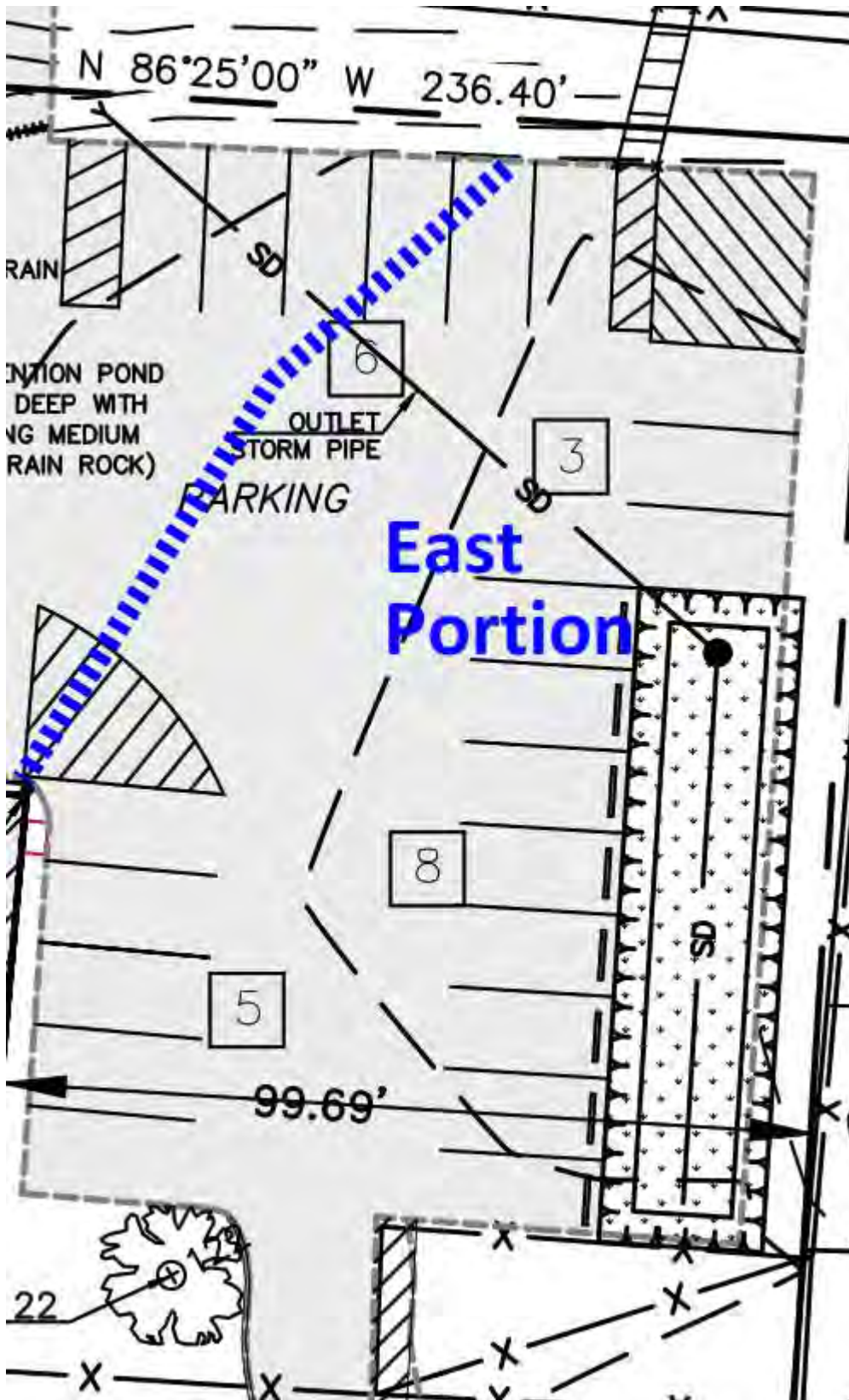

WES BMP Sizing Report

Project Information

Project Name	OrePac - East portion of the "L" Parking area
Project Type	Addition
Location	
Stormwater Management Area	1600
Project Applicant	
Jurisdiction	OutofDistrict

Drainage Management Area

Name	Area (sq-ft)	Pre-Project Cover	Post-Project Cover	DMA Soil Type	BMP
East Portion of "L" Parking area	8,450	Grass	ConventionalConcrete	B	BMP

LID Facility Sizing Details

LID ID	Design Criteria	BMP Type	Facility Soil Type	Minimum Area (sq-ft)	Planned Areas (sq-ft)	Orifice Diameter (in)
BMP	FlowControlAndTreatment	Rain Garden - Infiltration	B3	1,521.0	1,600.0	0.0

Post Developed: Existing West Portion Parking Lot Area

The existing parking and building area will have approximately 9,925 square feet of impervious area. Using the BMP Tool, proposing a pond size of 1,000 square feet, with walls on all 3 sides. Storm detention depth will be a maximum of 2 feet above the soil median for water quality.

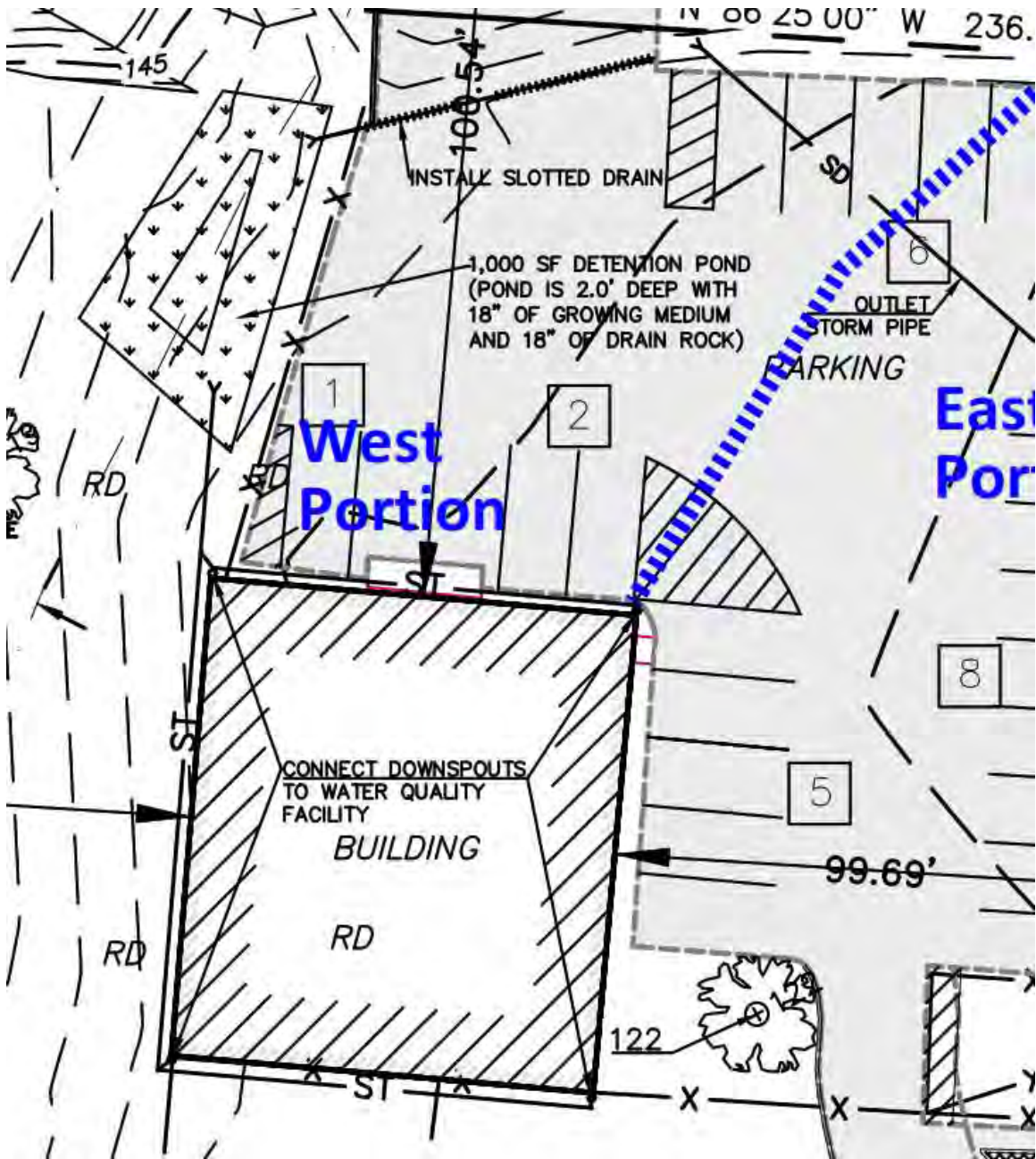

WES BMP Sizing Report

Project Information

Project Name	OrePac - West Portion of L-shaped Parking Area
Project Type	Addition
Location	
Stormwater Management Area	9925
Project Applicant	OrePac - Wilsonville
Jurisdiction	OutofDistrict

Drainage Management Area

Name	Area (sq-ft)	Pre-Project Cover	Post-Project Cover	DMA Soil Type	BMP
DMA	9,925	Grass	ConventionalConcrete	B	BMP

LID Facility Sizing Details

Pond Sizing Details

Pond ID	Design Criteria(1)	Facility Soil Type	Max Depth (ft)(2)	Top Area (sq-ft)	Side Slope (1:H)	Facility Vol. (cu-ft)(3)	Water Storage Vol. (cu-ft)(4)	Adequate Size?
BMP	FCWQT	B3	5.00	1,000.0	0	5,000.0	3,200.0	Yes

1. FCWQT = Flow control and water quality treatment, WQT = Water quality treatment only

2. Depth is measured from the bottom of the facility and includes the three feet of media (drain rock, separation layer and growing media).

3. Maximum volume of the facility. Includes the volume occupied by the media at the bottom of the facility.

4. Maximum water storage volume of the facility. Includes water storage in the three feet of soil media assuming a 40 percent porosity.

Simple Pond Geometry Configuration

Pond ID: BMP

Design: FlowControlAndTreatment

Shape Curve

Depth (ft)	Area (sq ft)
5.0	1,000.0

Outlet Structure Details

Lower Orifice Invert (ft)	0.0
Lower Orifice Dia (in)	0.2
Upper Orifice Invert(ft)	3.4
Upper Orifice Dia (in)	1.0
Overflow Weir Invert(ft)	4.0
Overflow Weir Length (ft)	6.3

Flow Frequency Chart

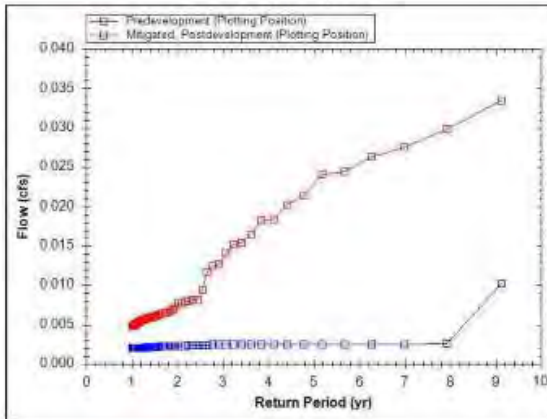

Flow Duration Chart

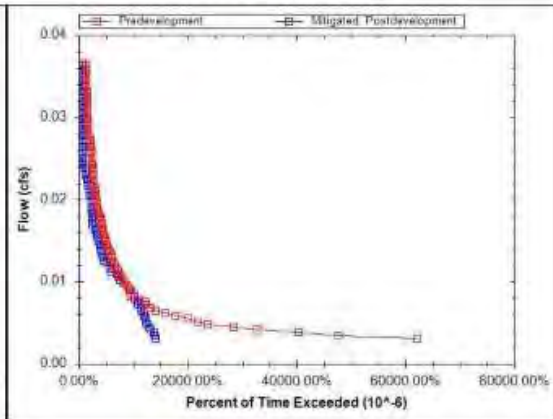

SUPPLEMENTAL PAGES

November 1, 2023

Mr. David Adams
Walen Construction, LLC
16655 SW 72nd Avenue, Suite 200
Portland, Oregon 97224

Dear Mr. Adams:

**Re: Geotechnical Consultation and Field Infiltration Testing Services,
Proposed Ore-Pac South Lot Expansion Project, Tax Lot No's. 101, 200 & 300,
30170 SW OrePac Avenue, Wilsonville (Clackamas County), Oregon**

Introduction

In accordance with the request of Mr. David Adams of Walen Construction, LLC, we have completed our geotechnical consultation and field infiltration testing services for the proposed new paved access drive and parking lot improvements as well as the proposed new stormwater management facilities at the proposed new Ore-Pac South Lot Expansion project site in Wilsonville (Clackamas County), Oregon (see attached Site Vicinity Map, Figure No. 1).

The purpose of our work at this time was to determine the existing subgrade soil classification (Resilient Modulus) across the proposed new south lot expansion area. Additionally, field infiltration testing was also performed at the site in accordance with the City of Wilsonville/Clackamas County encased single-sleeve falling head test method.

Specifically, on October 12, 2023, we were present at the site and excavated three (3) test holes across the proposed new south lot expansion site located to the north of SW 5th Street (see attached Site Exploration Plan, Figure No. 2).

The subgrade soil samples collected for laboratory testing were generally obtained by hand with portable excavation equipment at a depth of about 1.5 to 2.0 feet below the existing site and/or surface grades. The subgrade soils encountered in the exploratory test holes generally consisted of native and/or residual soils comprised of medium brown, moist to very moist, stiff to medium dense, clayey, fine sandy silt to clayey, silty fine sand (ML/SM).

The subgrade soil samples collected at the site were tested in the laboratory in accordance with the ASTM Vol. 4.08 Part D-2844-69 (AASHTO T-190-93) test method for the determination of the subgrade soil "R"-value and expansion pressure. The results of the "R"-value testing was then converted to an equivalent Resilient Modulus (MRSG) in accordance with current AASHTO methodology.

The results of the laboratory "R"-value tests revealed that the subgrade soils have an apparent "R"-value of about 36 (see attached Results of R (Resistance) Value Tests, Figure No. 3). Using the current AASHTO methodology for converting "R"-value to Resilient Modulus (MRSG), the subgrade soils have a Resilient Modulus (MRSG) of about 7,460 which is classified as "Fair" (MRSG = 5,000 psi to 10,000 psi). In addition to the above, we performed Dynamic Cone Penetration (DCP) tests within the bottom of test holes. The results of the DCP tests found that the exposed subgrade soils have a DCP value of between 3 and 4 blows per 2-inches which correlates to a California Bearing Ratio (CBR) of between 12 and 17. Using the current AASHTO methodology for converting CBR to Resilient Modulus (MRSG), the subgrade soils have a Resilient Modulus (MRSG) of between 7,355 and 10,637 psi with an average MRSG of 8,996 psi which is classified as "Fair" (MRSG = 5,000 psi to 10,000 psi).

Flexible Pavement Design

Flexible pavement design for the proposed Ore-Pac south lot expansion project was determined on the basis of projected traffic volume and loading conditions (i.e., 30 to 40 semi-trucks per day) relative to laboratory subgrade soil strength characteristics. Based on a subgrade "R"-value of 36 (Resilient Modulus = 7,460 psi) and utilizing the American Association of State Highway and Transportation Officials (AASHTO) 1993 "Design of Pavement Structures" manual, we have developed the following flexible pavement section for construction of the new south lot expansion project.

South Lot Expansion

The following documents and/or design input parameters were used to help determine the flexible pavement section design for the new South Lot paved truck access drive:

- . Design Life: 20 years
- . Serviceability: 4.2 initial, 2.5 terminal
- . Traffic Loading Data: 300,000 18-kip EAL's
- . Reliability Level: 90%
- . Drainage Coefficient: 1.0 (asphalt), 0.8 (aggregate)
- . Asphalt Structural Coefficient: 0.40
- . Aggregate Structural Coefficient: 0.10

Based on the above design input parameters and using the design procedures contained within the AASHTO 1993 Design of Pavement Structures manual, a Structural Number (SN) of 3.2 was determined.

In this regard we recommend the following flexible pavement section for the improvements to the proposed new South Lot truck access drive:

Material Type	Pavement Section (inches)
Asphaltic Concrete	5.0
Aggregate Base Rock	12.0

Site Grading and Subgrade Protection

We recommend that preparation of the street subgrade soils consist of the excavation down to firm and approved native and/or residual soils. Structural fill soils placed for construction of street subgrade should be compacted by mechanical means while at and/or near to optimum moisture content (plus or minus 3 percent) to a minimum of 90 percent of the maximum dry density as determined by the ASTM D-1557 (AASHTO T-180) test procedures. Additionally, the exposed subgrade soils shall be properly protected from rain and construction traffic prior to and/or during the placement of the crushed aggregate base rock materials.

Wet Weather Grading and Construction

Construction of the proposed new public streets is generally recommended during dry weather. However, during wet weather grading and construction, excavation to subgrade can proceed during periods of light to moderate rainfall provided that the subgrade remains covered with aggregate. A total aggregate thickness of 8-inches may be necessary to protect the subgrade soils from heavy construction traffic. Construction traffic should not be allowed directly on the exposed subgrade but only atop a sufficient compacted base rock thickness to help mitigate subgrade pumping. If the subgrade becomes wet and pumps, no construction traffic shall be allowed on the road alignment. Positive site drainage away from the street shall be maintained if site paving will not occur before the on-set of the wet season.

Mitigation of West and Soft Subgrade

Depending on the timing for the project, any soft subgrade found during proof-rolling or by visual observations can either be removed and replaced with properly dried and compacted fill soils or removed and replaced with compacted crushed aggregate. However, and where approved by the Geotechnical Engineer, the soft area may be covered with a bi-axial geogrid and covered with compacted crushed aggregate.

Soil Shrink-Swell and Frost Heave

The results of the laboratory "R"-value tests indicate that the native subgrade soils possess a low to moderate expansion potential. As such, the exposed subgrade soils should not be allowed to completely dry and should be moistened to near optimum moisture content (plus or minus 3 percent) at the time of the placement of the crushed base rock materials. Additionally, exposure of the subgrade soils to freezing weather may result in frost heave and softening of the subgrade.

As such, all subgrade soils exposed to freezing weather should be evaluated and approved by the Geotechnical Engineer prior to the placement of the crushed aggregate base rock materials.

Infiltration Testing

Field infiltration testing was performed in FITH-#1, FITH-#2 and FITH-#3 at depths of between 3.0 and 5.0 feet beneath the existing site and/or surface grades in general conformance with the City of Wilsonville/Clackamas County Encased Single-Sleeve Falling Head test method.

The test method consists of advancing a 6-inch diameter PVC pipe approximately 6 inches into the exposed soil horizon at the test location. Using a steady water flow, water was discharged into the pipe and allowed to penetrate the subgrade soils. The water level was adjusted over an approximate 2-hour period and allowed to achieve a saturated subgrade soil condition consistent with the bottom of the surrounding test hole excavation. Following the required saturation period, water was again added into the pipe and the time and/or rate at which the water level dropped was monitored and recorded. Each measurable drop in the water level was recorded in approximate 20-minute intervals until a consistent infiltration rate was observed and/or repeated.

Based on the results of the field infiltration testing at the site, we have found that the native clayey, fine sandy silt to silty fine sand subgrade soil materials possess an ultimate infiltration rate of between 1.0 inches per hour (in/hr) to 2.0 inches per hour (in/hr). In this regard, for design purposes, we recommend an allowable infiltration rate of between 0.5 to 1.0 inches per hour (in/hr).

We appreciate this opportunity to be of service to you at this time and trust that the above information is suitable to your present needs. Should you have any questions regarding the above information or if you require any additional information and/or assistance, please do not hesitate to call.

Sincerely,

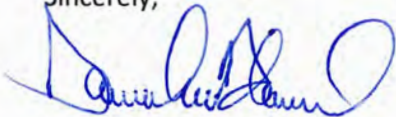

Daniel M. Redmond, P.E., G.E.
President/Principal Engineer

Cc: Mr. Tom Sisul
Sisul Engineering



Attachments:

- Figure No. 1 - Site Vicinity Map
- Figure No. 2 - Site Exploration Plan
- Figure No. 3 - Results of R (Resistance) Value Tests
- Figure No's. 4 through 6 - Infiltration Test Results

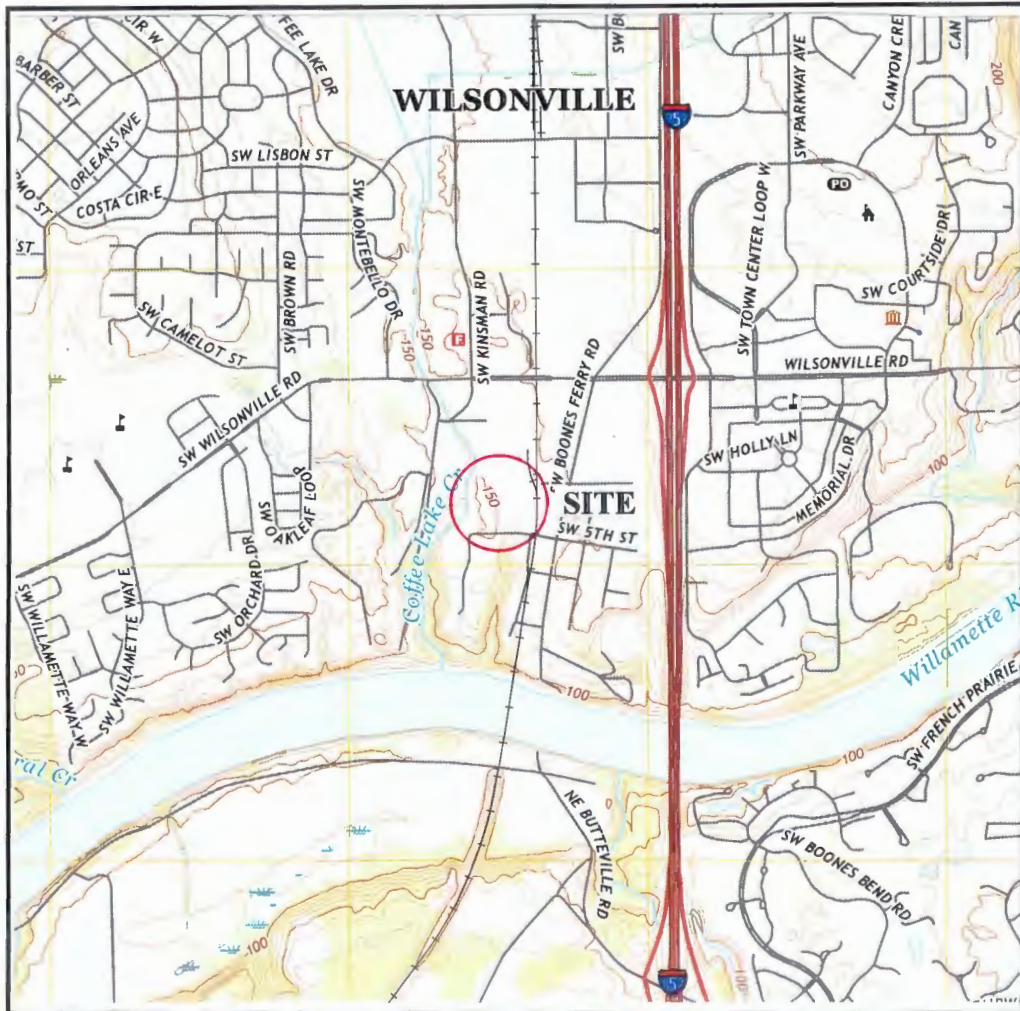

**SHERWOOD QUADRANGLE
OREGON
7.5-MINUTE SERIES**

SCALE 1:24 000

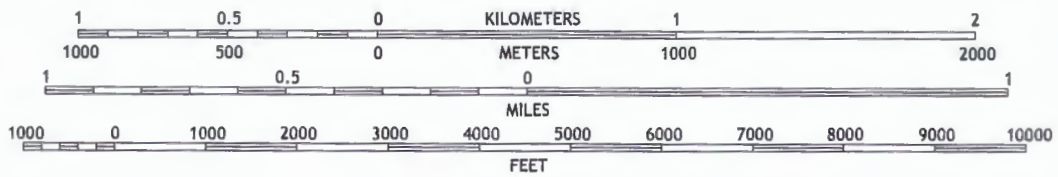

CONTOUR INTERVAL 10 FEET
NORTH AMERICAN VERTICAL DATUM OF 1988

SITE VICINITY MAP

**ORE-PAC SOUTH LOT EXPANSION
TAX LOT'S 101, 200 & 300**

Project No. 1859.002.G

Figure No. 1

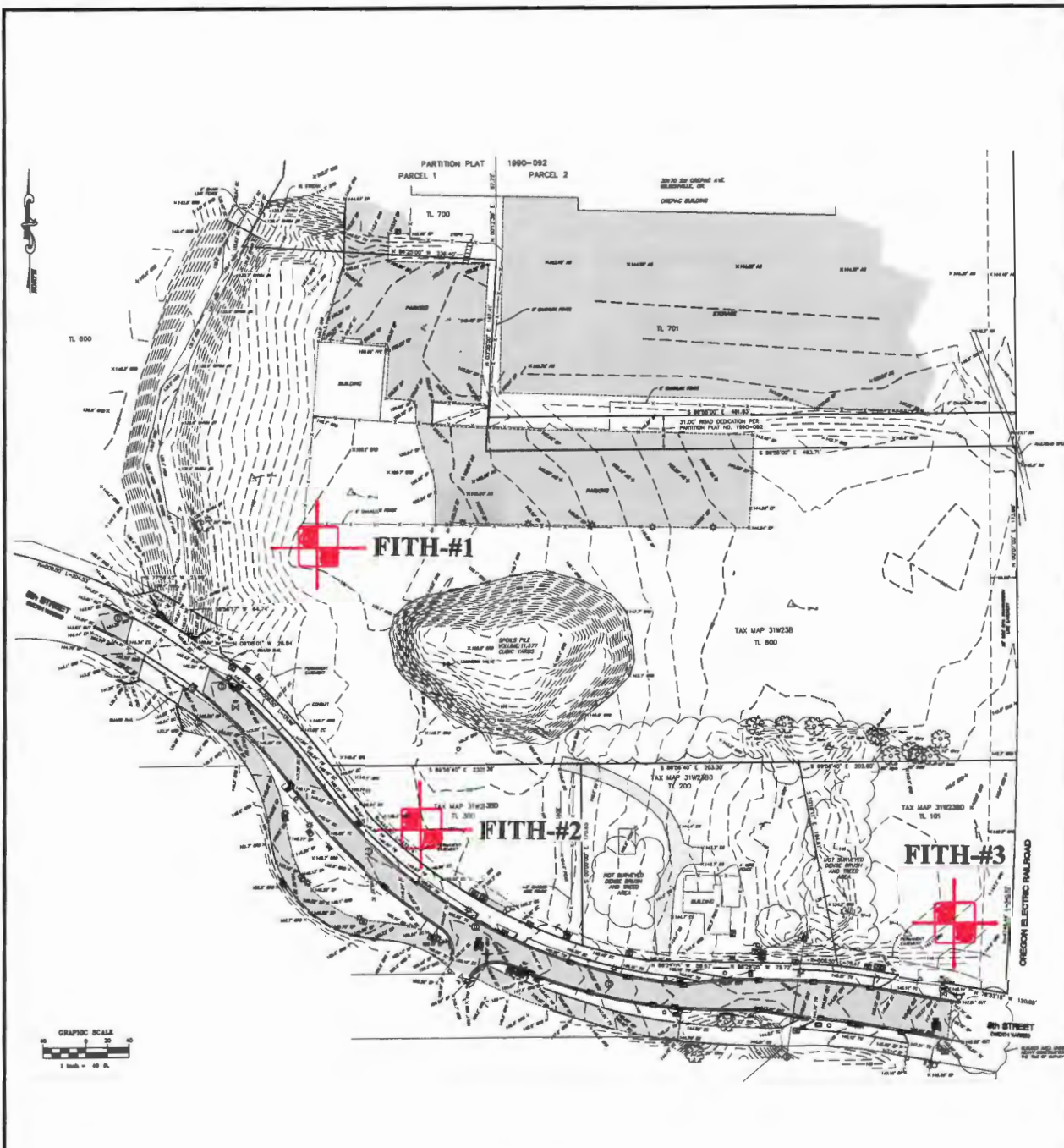

LEGEND

FITH-#3 Indicates approximate location of field infiltration test hole

SITE EXPLORATION PLAN

**ORE-PAC SOUTH LOT EXPANSION
TAX LOT'S 101, 200 & 300**

Project No. 1859.002.G

Figure No. 2

RESULTS OF R (RESISTANCE) VALUE TESTS

SAMPLE LOCATION: FITH-#3

SAMPLE DEPTH: 2.0 feet bgs

Specimen	A	B	C
Exudation Pressure (psi)	219	322	431
Expansion Dial (0.0001")	0	0	1
Expansion Pressure (psf)	0	0	3
Moisture Content (%)	19.6	15.4	11.1
Dry Density (pcf)	106.7	109.4	112.5
Resistance Value, "R"	19	37	50
"R"-Value at 300 psi Exudation Pressure = 36			

SAMPLE LOCATION:

SAMPLE DEPTH:

Specimen	A	B	C
Exudation Pressure (psi)			
Expansion Dial (0.0001")			
Expansion Pressure (psf)			
Moisture Content (%)			
Dry Density (pcf)			
Resistance Value "R"			
"R"-Value at 300 psi Exudation Pressure =			

Figure No. 3

Field Infiltration Test Results

Location: OrePac South Lot Expansion	Date: October 12, 2023	Test Hole: FITH-#1
Depth to Bottom of Hole: 5.0 feet	Hole Diameter: 6 inches	Test Method: Encased Falling Head
Tester's Name: Daniel M. Redmond, P.E., G.E.		
Tester's Company: Redmond Geotechnical Services, LLC		Tester's Contact Number: 503-285-0598
Depth (feet)	Soil Characteristics	
0.0-1.0	Dark brown, sandy, clayey SILT (TOPSOIL)	
1.0-5.0	Medium brown, clayey, fine sandy SILT (ML)	

Time	Time Interval (Minutes)	Measurement (inches)	Drop in Water (inches)	Infiltration Rate (inches/hour)	Remarks
1:00	0	48.00	----		Filled w/12" water
1:10	10	48.43	0.43	2.58	
1:20	10	48.81	0.38	2.28	
1:30	10	49.17	0.36	2.16	
1:40	10	49.52	0.35	2.10	
1:50	10	48.35	0.35	2.10	Filled w/12" water
2:00	10	48.69	0.34	2.04	
2:10	10	49.03	0.34	2.04	
2:20	10	49.37	0.34	2.04	

Infiltration Test Data Table

Field Infiltration Test Results

Location: OrePac South Lot Expansion	Date: October 12, 2023	Test Hole: FITH-#2
Depth to Bottom of Hole: 3.0 feet	Hole Diameter: 6 inches	Test Method: Encased Falling Head
Tester's Name: Daniel M. Redmond, P.E., G.E.		
Tester's Company: Redmond Geotechnical Services, LLC		Tester's Contact Number: 503-285-0598
Depth (feet)	Soil Characteristics	
0.0-1.0	Dark brown, sandy, clayey SILT (TOPSOIL)	
1.0-3.0	Medium brown, clayey, fine sandy SILT (ML)	

Time	Time Interval (Minutes)	Measurement (inches)	Drop in Water (inches)	Infiltration Rate (inches/hour)	Remarks
1:05	0	24.00	----		Filled w/12" water
1:15	10	24.23	0.23	1.38	
1:25	10	24.43	0.20	1.20	
1:35	10	24.62	0.19	1.14	
1:45	10	24.80	0.18	1.08	
1:55	10	24.98	0.18	1.08	
2:05	10	25.15	0.17	1.02	
2:15	10	25.32	0.17	1.02	
2:25	10	25.49	0.17	1.02	

Infiltration Test Data Table

Field Infiltration Test Results

Location: OrePac South Lot Expansion	Date: October 12, 2023	Test Hole: FITH-#3
Depth to Bottom of Hole: 4.0 feet	Hole Diameter: 6 inches	Test Method: Encased Falling Head
Tester's Name: Daniel M. Redmond, P.E., G.E.		
Tester's Company: Redmond Geotechnical Services, LLC		Tester's Contact Number: 503-285-0598
Depth (feet)	Soil Characteristics	
0.0-1.0	Dark brown, sandy, clayey SILT (TOPSOIL)	
1.0-4.0	Medium brown, clayey, fine sandy SILT (ML)	

Time	Time Interval (Minutes)	Measurement (inches)	Drop in Water (inches)	Infiltration Rate (inches/hour)	Remarks
1:05	0	36.00	----		Filled w/12" water
1:15	10	36.40	0.40	2.40	
1:25	10	36.74	0.34	2.04	
1:35	10	37.05	0.31	1.86	
1:45	10	37.34	0.29	1.74	
1:55	10	36.28	0.28	1.68	Filled w/12" water
2:05	10	36.55	0.27	1.62	
2:15	10	36.82	0.27	1.62	
2:25	10	37.09	0.27	1.62	

Infiltration Test Data Table

Soil Map—Clackamas County Area, Oregon



Soil Map may not be valid at this scale.

Map Scale: 1:1,570 if printed on A portrait (8.5" x 11") sheet.

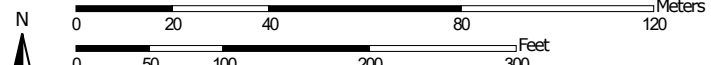

Map projection: Web Mercator Corner coordinates: WGS84 Edge tics: UTM Zone 10N WGS84

MAP LEGEND

Area of Interest (AOI)

 Area of Interest (AOI)

Soils

 Soil Map Unit Polygons

 Soil Map Unit Lines

 Soil Map Unit Points

Special Point Features



Blowout



Borrow Pit



Clay Spot



Closed Depression



Gravel Pit



Gravelly Spot



Landfill



Lava Flow



Marsh or swamp



Mine or Quarry



Miscellaneous Water



Perennial Water



Rock Outcrop



Saline Spot



Sandy Spot



Severely Eroded Spot



Sinkhole



Slide or Slip



Sodic Spot



Spoil Area



Stony Spot



Very Stony Spot



Wet Spot



Other



Special Line Features

Water Features



Streams and Canals

Transportation



Rails



Interstate Highways



US Routes



Major Roads



Local Roads

Background



Aerial Photography

MAP INFORMATION

The soil surveys that comprise your AOI were mapped at 1:20,000.

Warning: Soil Map may not be valid at this scale.

Enlargement of maps beyond the scale of mapping can cause misunderstanding of the detail of mapping and accuracy of soil line placement. The maps do not show the small areas of contrasting soils that could have been shown at a more detailed scale.

Please rely on the bar scale on each map sheet for map measurements.

Source of Map: Natural Resources Conservation Service

Web Soil Survey URL:

Coordinate System: Web Mercator (EPSG:3857)

Maps from the Web Soil Survey are based on the Web Mercator projection, which preserves direction and shape but distorts distance and area. A projection that preserves area, such as the Albers equal-area conic projection, should be used if more accurate calculations of distance or area are required.

This product is generated from the USDA-NRCS certified data as of the version date(s) listed below.

Soil Survey Area: Clackamas County Area, Oregon

Survey Area Data: Version 20, Sep 7, 2023

Soil map units are labeled (as space allows) for map scales 1:50,000 or larger.

Date(s) aerial images were photographed: Sep 26, 2022—Oct 11, 2022

The orthophoto or other base map on which the soil lines were compiled and digitized probably differs from the background imagery displayed on these maps. As a result, some minor shifting of map unit boundaries may be evident.

Map Unit Legend

Map Unit Symbol	Map Unit Name	Acres in AOI	Percent of AOI
53A	Latourell loam, 0 to 3 percent slopes	0.8	22.0%
53B	Latourell loam, 3 to 8 percent slopes	3.0	77.0%
71A	Quatama loam, 0 to 3 percent slopes	0.0	1.0%
Totals for Area of Interest		3.8	100.0%

250'-0"

100'-0"

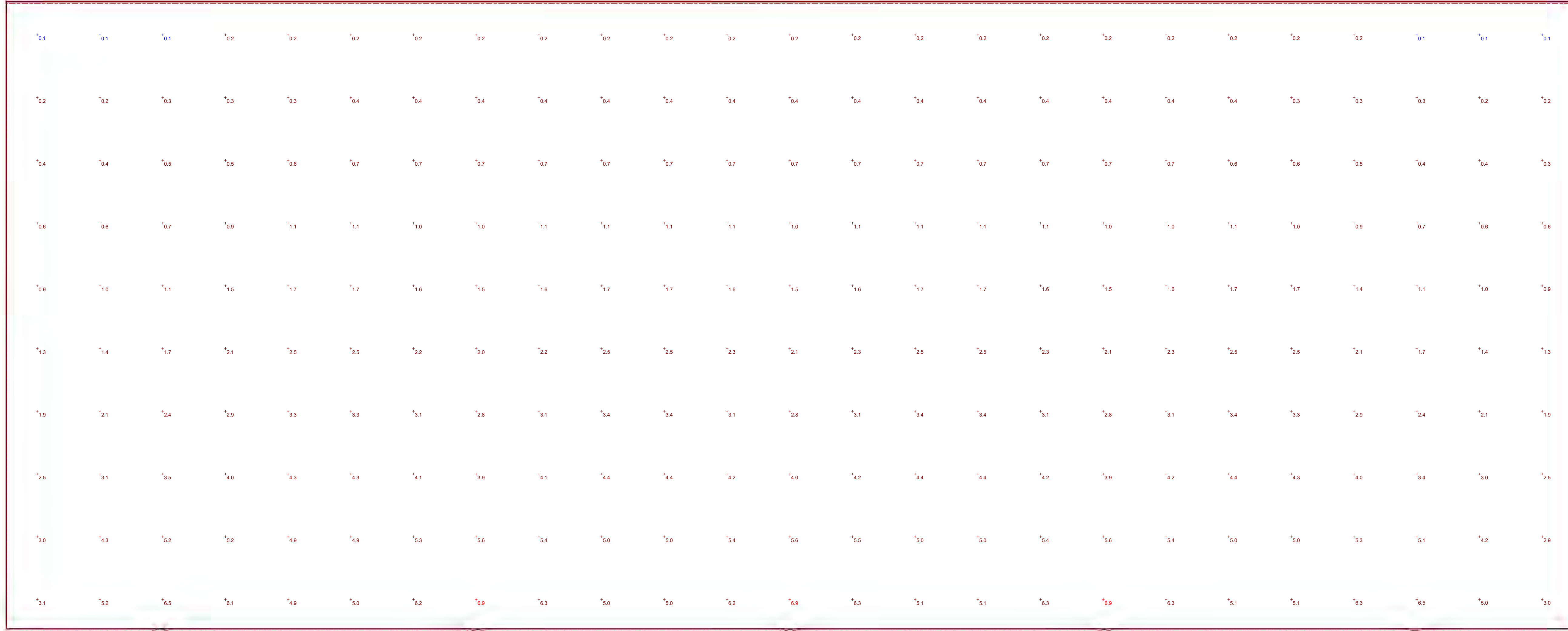

Plan View

Atlas Lighting Products **Alpha LED** **Site Lighter Pro**

SLP22270LED 270 Watt LED Site Lighter Pro



Project Information	
Job Name	
Fixture Type	270 Watt LED Site Lighter Pro
Catalog Number	SLP22270LED
Approved by	

SPECIFICATIONS:

	SLP22270LEDT3	SLP22270LEDT4	SLP22270LEDT5
Lumens:	26,820	24,170	26,010
Watts:	275.2	273.5	270.4
Lumens/Watt:	97.43	88.37	96.17
CRI:	73.2	73.4	73.8
CCT:	4124	4203	4383
Lifespan:	200,000+ hrs. ¹	200,000+ hrs. ¹	200,000+ hrs. ¹

Alpha Series LED
PROFESSIONAL GRADE



Construction:

Designed for commercial and industrial applications, providing cooler operating temperatures, brighter light and longer LED life. The housing is made of 100% aluminum and utilizes external airflow fins allow for greater heat dissipation. The easy access driver compartment is a thermally independent compartment, separate from LED generated heat, for cooler operation and longer driver life.

Optics:

Atlas Site Lighter Pro fixtures utilize precision engineered individual lenses for maximum light intensity. These lenses are made of optical grade polycarbonate. Types III, IV, V and forward throw distributions are available.

Mounting:

The easy mount bracket makes installation to any style pole quick and easy. Tenon and other mounting accessories also available.

Thermal Management:

Atlas Site Lighter Pro fixtures are designed as a complete system to optimize LED life and light output. The Patent Pending thermal stacking heat removal technology extracts heat from within the housing moving it away from LEDs and components. The lower temperatures result in long LED life (200,000+ hrs) and component life and also allows for higher light output.

Listings:

Luminaire is certified to UL Standards for Wet Locations
Lighting Facts Certified
DesignLights Consortium qualified luminaire, eligible for rebates from DLC member utilities.

AC Input:

120/208/240/277 V

Driver:

Constant current, Class 2, 120-277 VAC, 50-60 Hz
High Efficiency – min. 88%
Off-State Power: 0 Watts
Dimming 0-10V

LEDs:

4500K CCT
Epoxy Guard™ protective conformal coated boards

Reduced Glare:

Positioning of the LED modules within the housing result in light directed to desired locations and reduces offensive light.

Testing:

Atlas LED luminaires have been tested by an independent laboratory in accordance with IESNA LM-79 & LM-80, and have received the Department of Energy "Lighting Facts" label.

Warranty:

Five-year limited warranty

DIMENSIONS:

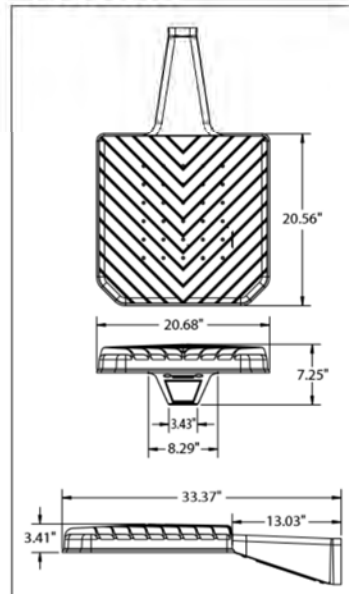

Rebates and Incentives are available in many areas. Contact an Atlas Representative for more information.

¹LED Life Span Based Upon LM-80 Test Results

ATLAS LIGHTING PRODUCTS, INC.

PO BOX 2348 | BURLINGTON, NC 27216
800-849-8485 | FAX: 336-227-0110 | www.atlasled.com

Made in the USA of US and imported parts. Meets Buy American requirements within the ARRA.



Site Lighter Pro

SLP22270LED 270 Watt LED Site Lighter Pro

ORDERING INFORMATION

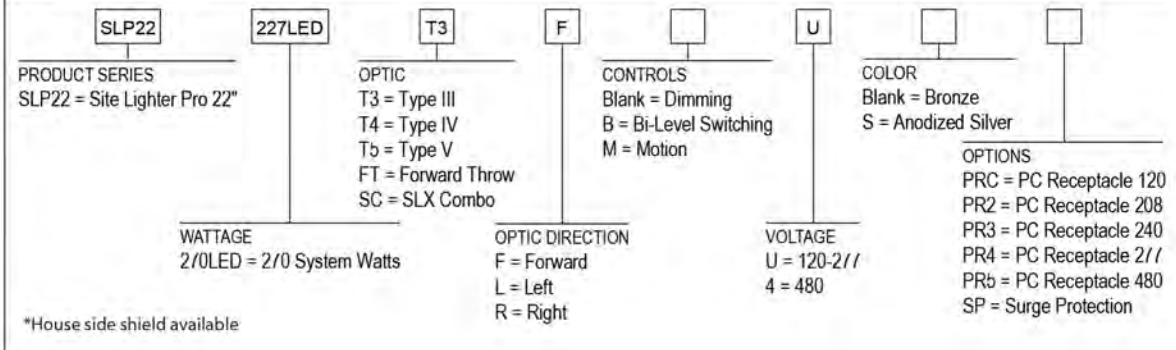

LED lighting facts
A Project of the U.S. DOE

Light Output (Lumens)	26820
Watts	275.2
Lumens per Watt (Efficacy)	97.43

Color Accuracy
Color Rendering Index (CRI) 73

Light Color
Correlated Color Temperature (CCT) 4124 (Bright White)

Visit www.lightingfacts.com for the Label Reference Guide.

Product Number: PSM-RTV17M-011010
Model Number: SLP22270LED1
Type: Luminaire - Pole-Mounted

LED lighting facts
A Project of the U.S. DOE

Light Output (Lumens)	24170
Watts	273.5
Lumens per Watt (Efficacy)	88.37

Color Accuracy
Color Rendering Index (CRI) 73

Light Color
Correlated Color Temperature (CCT) 4203 (Bright White)

Visit www.lightingfacts.com for the Label Reference Guide.

Product Number: PSM-RTV17M-011010
Model Number: SLP22270LED1
Type: Luminaire - Pole-Mounted

LED lighting facts
A Project of the U.S. DOE

Light Output (Lumens)	26010
Watts	270.4
Lumens per Watt (Efficacy)	96.17

Color Accuracy
Color Rendering Index (CRI) 73

Light Color
Correlated Color Temperature (CCT) 4383 (Bright White)

Visit www.lightingfacts.com for the Label Reference Guide.

Product Number: PSM-RTV17M-011010
Model Number: SLP22270LED1
Type: Luminaire - Pole-Mounted

ATLAS LIGHTING PRODUCTS, INC.
PO BOX 2348 | BURLINGTON, NC 27216
800-849-8485 | FAX: 336-227-0110 | www.atlasled.com

Made in the USA of US and imported parts. Meets Buy American requirements within the ARRA.



O-SERIES

Composite Light pole

O-Series

Direct Burial

ROUND TAPERED COMPOSITE LIGHT POLE DIRECT BURIAL INSTALLATION

SHAKESPEARE O-SERIES DIRECT BURIAL POLES



OVERALL LENGTH	MOUNTING HEIGHT	BURIAL DEPTH	TIP DIAMETER	GROUNDLINE DIAMETER	WEIGHT
13	10	3	4.1	5.4	26
14	11	3	4.1	5.6	29
15	12	3	4.1	5.7	31
16	13	3	4.1	5.8	34
18	14	4	4.1	5.9	37
19	15	4	4.1	6.1	38
20	16	4	4.1	6.2	42
21	17	4	4.1	6.3	45
22	18	4	4.1	6.5	49
23	19	4	4.1	6.6	51
24	20	4	4.1	6.7	52

- Mounting heights to 20 feet
- Smooth, semi-smooth or natural finish
- 3 standard and 5 special architectural colors available
- High performance UV and weather-resistant pigmented resin system with an additional pigmented polyurethane coating.
- Tenon top or Drilled and Capped
- Standard 2-1/2" x 5" handhole located 18" above grade
- Standard 2 EA - 2-1/2" x 6" wire access hole 24" below grade
- Anti-rotation flare structurally integrated into the pole base during manufacture
- Poles are individually identified with a permanent embossed tag located 9" from tip.
- Sleeved individually for shipment
- Lightweight, easy to install, saves money

ORDERING INFORMATION

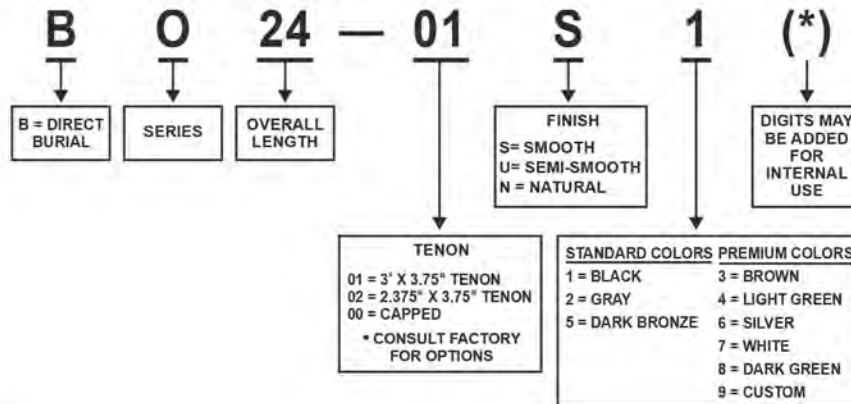

Base Dia = Groundline Dia +3.75"

O-SERIES



ROUND TAPERED COMPOSITE LIGHT POLE - DIRECT BURIAL INSTALLATION

SPECIFICATIONS

1. Lighting poles shall be fiberglass reinforced composite per Shakespeare design.
2. Wind loading shall be calculated for the appropriate wind velocity with a 3 second gust factor per ASCE.
3. Effective projected area (EPA) is the actual area adjusted with the appropriate drag coefficient (shape factor) to result in an equivalent area having a drag coefficient equal to one (1) using ANSI 136.20

MATERIALS

1. The round tapered pole shall be constructed by the filament winding process from thermosetting polyester resin and contain a minimum of 65 percent "E" type fiberglass by weight. The filament windings shall be continuously applied with uniform tension and shall be placed on the pole helically at low angles to provide axial strength. Additional windings shall be placed on the pole in a circular manner to provide compressive strength.
2. The resin to make the pole shall be ultraviolet resistant and pigmented approximately the same color as the final coating to be applied. A highly weather resistant, pigmented, polyurethane coating shall be applied to the pole. The coating shall have a minimum thickness of 1.5 mils.
3. The poles shall be flame resistant per ASTM D635. Specimens must cease to burn before the gauge mark of 100mm (3.9 inches) is reached.
4. (If applicable) The poles shall be delivered predrilled and capped (if applicable) to accommodate the lighting fixture(s) or mast arm(s) specified.
5. (If applicable) Tenons shall be permanently bonded to the fiberglass shaft and shall be hot-dipped galvanized steel to ASTM A153 or shall be 6061-T6 or A356-T6 aluminum.
6. The handhole opening shall be 2.5" x 5". The handhole cover is attached with a 1/4" socket head screw.

IDENTIFICATION & PACKAGING

Each pole shall bear an identification tag which shall list the model, catalog number, month and year of manufacture.
 Each pole shall be individually packaged for protection during shipping.

TESTING

The surface shall have been tested for a minimum of 5000 hours of accelerated testing in accordance with ASTM G154 (UV-A Lamp 340 NM wavelength 130° F, cycle lamp 4 hours on, 4 hours off) with the following performance results:

- Fiber exposure: None | Cracking: None | Chalking: None | Color: Slight dulling may occur

WIND LOADING DATA

Wind speed (mph) values calculated as per ANSI C136.20 for a 3-second gust factor.

OVERALL LENGTH	MOUNTING HEIGHT	LUMINAIRE MAX WEIGHT (LBS.)	90 MPH	100 MPH	110 MPH	120 MPH	130 MPH	140 MPH	150 MPH
13	10	150	11.8	9.2	7.5	6.2	5.2	4.4	3.8
14	11	150	11.3	8.8	7.2	5.9	5.0	4.2	3.6
15	12	150	10.2	8.0	6.5	5.3	4.4	3.7	3.2
16	13	150	9.4	7.4	5.9	4.9	4.1	3.4	2.9
18	14	150	8.7	6.8	5.5	4.5	3.7	3.1	2.6
19	15	100	9.2	8.0	6.5	5.3	4.4	3.7	3.1
20	16	100	9.3	7.3	5.9	4.8	4.0	3.3	2.8
21	17	100	8.6	6.7	5.4	4.4	3.6	3.0	2.5
22	18	100	7.9	6.1	4.9	3.9	3.2	2.7	2.2
23	19	100	7.2	5.6	4.4	3.6	2.9	2.4	2.0
24	20	100	6.6	5.1	4.0	3.2	2.6	2.1	1.8

Direct Embedded Detail

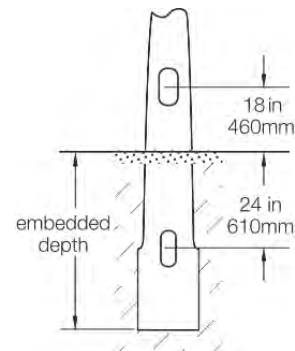

SPC7695 11/15 skp-cs.com carries the most current spec information and supersedes these guidelines.



PRE-APPLICATION NOTES

Site Address

30170 SW OrePac Avenue

Tax Lot

31W23B TL 600, 680, 700, 701, 780, 791

Existing Site Description:

Existing OrePac Facility

Proposed Development:

Code compliance – parking lot

Zoning:

Planned Development Industrial (PDI)



TRANSPORTATION

5th STREET/KINSMAN ROAD

Classification: Collector

Jurisdiction: City of Wilsonville

EXISTING CONDITIONS:

Recently upgraded to urban collector street standards by City Capital Project. Construction drawings attached for information only. Construction is not complete and as-built drawings are not yet available.

IMPROVEMENTS:

None anticipated with parking lot expansion.

FIGURE 3-8. COLLECTOR CROSS-SECTION

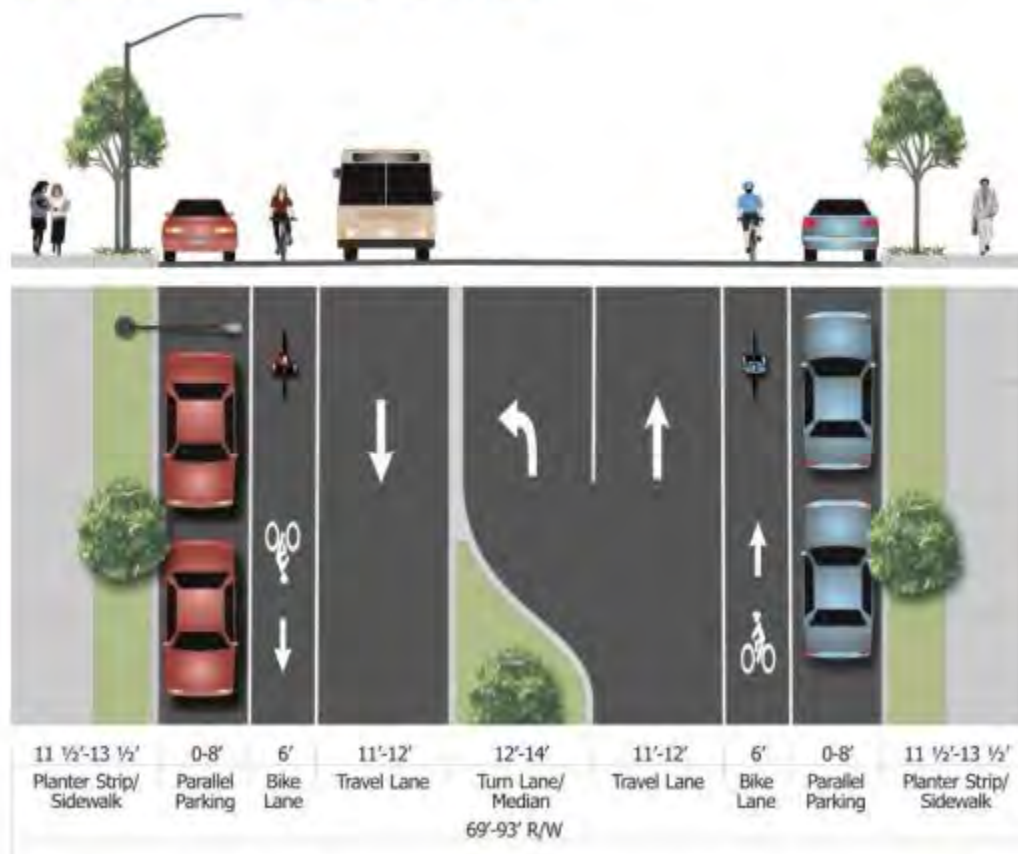

TRAFFIC IMPACT STUDY

A traffic impact study is required when three (3) new vehicular trips are generated. Parking lot expansions to not generate new vehicular trips. If in fact there are three (3) new vehicular trips created, the City will contact DKS, Traffic Consultants, for scope of work of the traffic impact study. For new trip between 3 and 25, a full-scale traffic impact study may not be necessary; a trip generation memo will be sufficient. The traffic analysis performed may identify improvements or mitigations required to address impacts from the newly generated trips.

The applicant will be responsible to pay for the consultant's fee plus 15% overhead to the City.

STREET LIGHTS

EXISTING:

Street lights exist along SW 5th Street/Kinsman Road.

IMPROVEMENTS:

None anticipated.

STREET TREES

EXISTING:

Street trees were installed as part of the SW 5th Street/Kinsman Road improvements.

IMPROVEMENTS:

None anticipated.

UNDERGROUNDING OF OVERHEAD UTILITIES

EXISTING:

Power poles, power lines, and other aerial utility lines are underground along SW 5th Street/Kinsman Road.

IMPROVEMENTS:

All new utilities shall be installed underground.

ACCESS SPACING STANDARDS

Refer to Table 2.12 from the Public Works Standards for access spacing requirements (also provided to the right).

Table 2.12. ACCESS SPACING STANDARDS

Roadway Functional Classification	Access Spacing Desired	Access Spacing Minimum
Major Arterial	1320 feet	1000 feet
Minor Arterial	1000 feet	600 feet
Collector	300 feet	100 feet
Local Street	Access to Each Lot	

FIVE YEAR STREETS CIP FORECAST FY2022-23 THRU FY2026-27

Project Name	Funding Source(s)
5th Street / Kinsman Extension Phase 1	Year 2000
I-5 Pedestrian Bridge.....	Road SDC
Boeckman Road Street Improvements.....	Road SDC / Frog Pond Dev.
Canyon Creek / Boeckman Signal	Road SDC
French Prairie Bridge.....	Road SDC
Boeckman Dip Bridge.....	Year 2000
Brown Road Improvements.....	West Side Urban Renewal
Garden Acres/Day Road Intersection	Coffee Creek Urban Renewal
Stafford/Frog Pond Intersection Improvements	Road SDC / Frog Pond Dev.
Street Maintenance Allocation to Charbonneau.....	Road Maintenance

SANITARY SEWER

EXISTING CONDITIONS:

15-inch PVC sanitary sewer mains are located within SW 5th Street and Kinsman right-of-ways.

IMPROVEMENTS:

None anticipated for a parking lot expansion.

FIVE YEAR SANITARY SEWER CIP FORECAST FY2022-2023 THRU FY2026-27

Project Name	Funding Source(s)
5th Street / Kinsman Extension Sewer Trunk.....	Sewer SDC
Boeckman Road Sanitary Improvements (Frog Pond).....	Sewer SDC/Frog Pond Dev
Boeckman Creek Interceptor	Sewer Ops/Sewer SDC
Corral Creek & Rivergreen Pump Station Rehabilitation.....	Sewer Ops
Charbonneau Lift Station Rehabilitation	Sewer Ops
Coffee Creek Interceptor Phase II.....	Sewer Ops/Sewer SDC
Town Center Pump Station Replacement	Sewer Ops
Coffee Creek Interceptor Railroad Crossing	Sewer Ops/Sewer SDC
Coffee Creek Day Road Sewer Extension.....	Coffee Creek Urban Renewal
Willamette Way West Sewer Rehabilitation	Sewer Ops
WWTP Clarifier Mechanisms Replacement	Sewer Ops
Day Dream Sewer Rehabilitation Phase I	Sewer Ops
Sewer Operations Allocation to Charbonneau	Sewer Ops

DOMESTIC WATER

EXISTING CONDITIONS:

A 12-inch ductile iron water pipeline runs within the SW 5th Street and Kinsman Road right-of-ways. An 8" stub was installed at the new driveway approach along SW 5th Street to serve future development on this site. The property has an existing domestic and irrigation meter.

IMPROVEMENTS:

None anticipated for parking lot expansion.

FIVE YEAR WATER CIP FORECAST FY2022-23 THRU FY2026-27

Project Name	Funding Source(s)
5 th Street / Kinsman Extension Water Line	Water SDC
WTP 20 MGD Expansion	Water Ops/SDC/Sherwood
Water Ops Allocation to Charbonneau.....	Water Ops
Priority 1B Water Distribution Improvements	Water Ops
West Side Level B Reservoir and Off-Site Improvements.....	Water SDC
Automated Valve at Tooze/Westfall.....	Water SDC
Elligsen West Tank – Add Altitude Valve	Water SDC
Elligsen Reservoir Fall Protection System Replacement.....	Water Ops
16" Willamette River Crossing to Charbonneau District	Water Ops
Reservoir Security Improvements	Water Ops

STORM WATER

EXISTING CONDITIONS:

The site appears to drain toward 2 different drainage basins (Coffee Lake Creek to the west and an unnamed tributary to the south). The City installed a 24" main and ditch inlet at the southern boundary of the site as part of the 5th to Kinsman project

IMPROVEMENTS:

The proposed development will create more than 5,000 square feet of new or replacement impervious area, it must address the City's Standards Requirements for stormwater treatment, retention, and flow control. Stormwater facilities shall be integrated dispersed through the site (one facility not allowed). Stormwater shall remain in pre-development drainage basins. Stormwater facilities: rain gardens and/or infiltration basins are subject to engineering review and approval. Proprietary devices are not allowed. A PW Permit will be required prior to the construction of the stormwater facilities. A stormwater maintenance and easement agreements between the City and the Developer shall be recorded prior to final approvals.

FIVE YEAR STORM WATER CIP FORECAST FY2022-23 THRU FY2026-27

Project Name	Funding Source(s)
Gesellschaft Water Well Channel Restoration	Stormwater Ops/SDC
Boeckman Creek Hydraulic Analysis	Stormwater Ops/SDC
Storm Operations Allocation to Charbonneau	Stormwater Ops
Meridian Creek Culvert Replacement.....	Stormwater Ops/SDC
Canyon Creek Estates Pipe Removal.....	Stormwater
Rose Lane Culvert Replacement	Stormwater Ops
Coffee Creek Storm System	Stormwater Ops
Willamette Way East Bubbler Repair	Stormwater Ops

OTHER

Stormwater System Development Charges will be due at the time of permit issuance for the new impervious area.

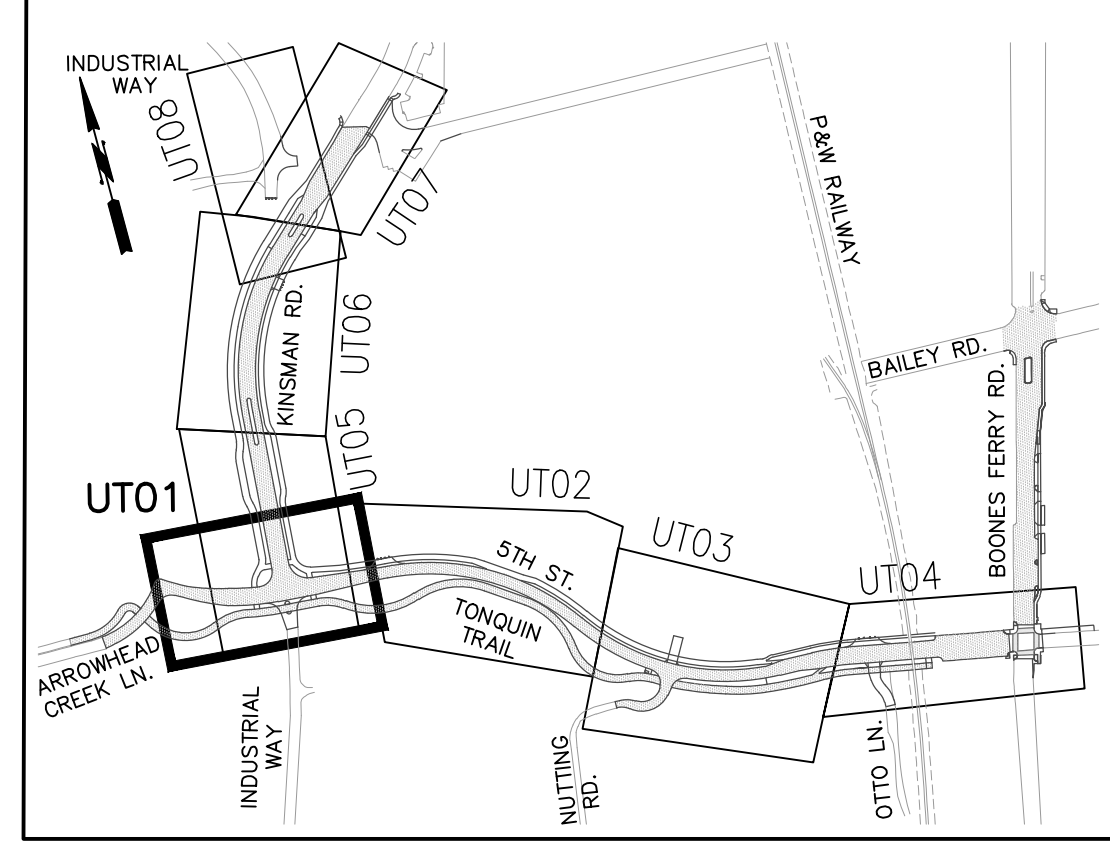
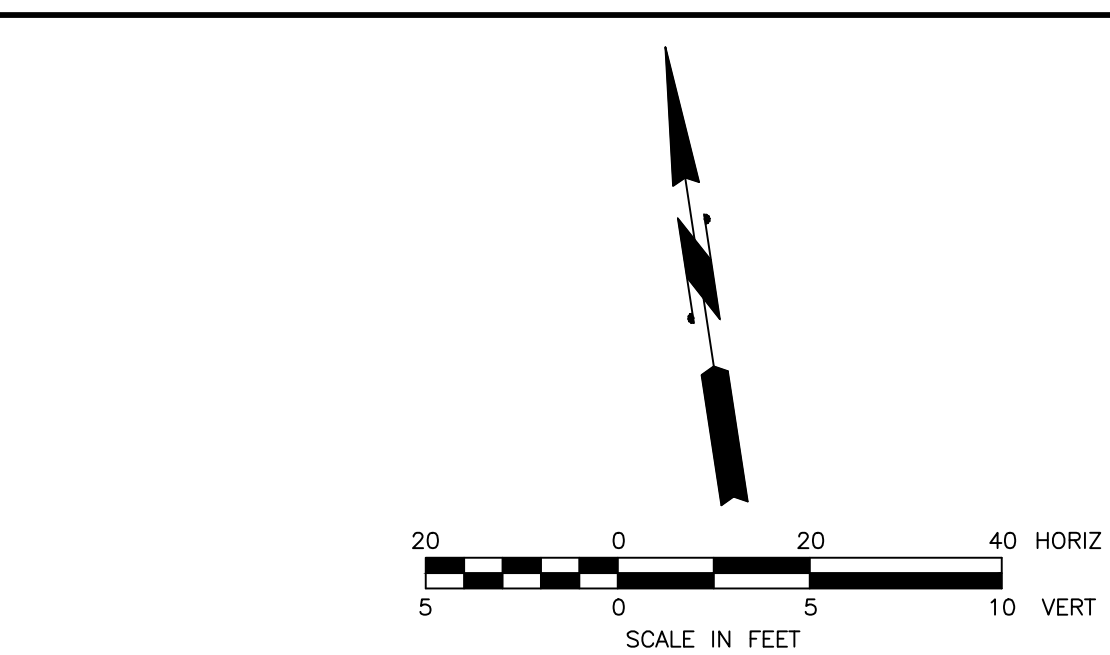
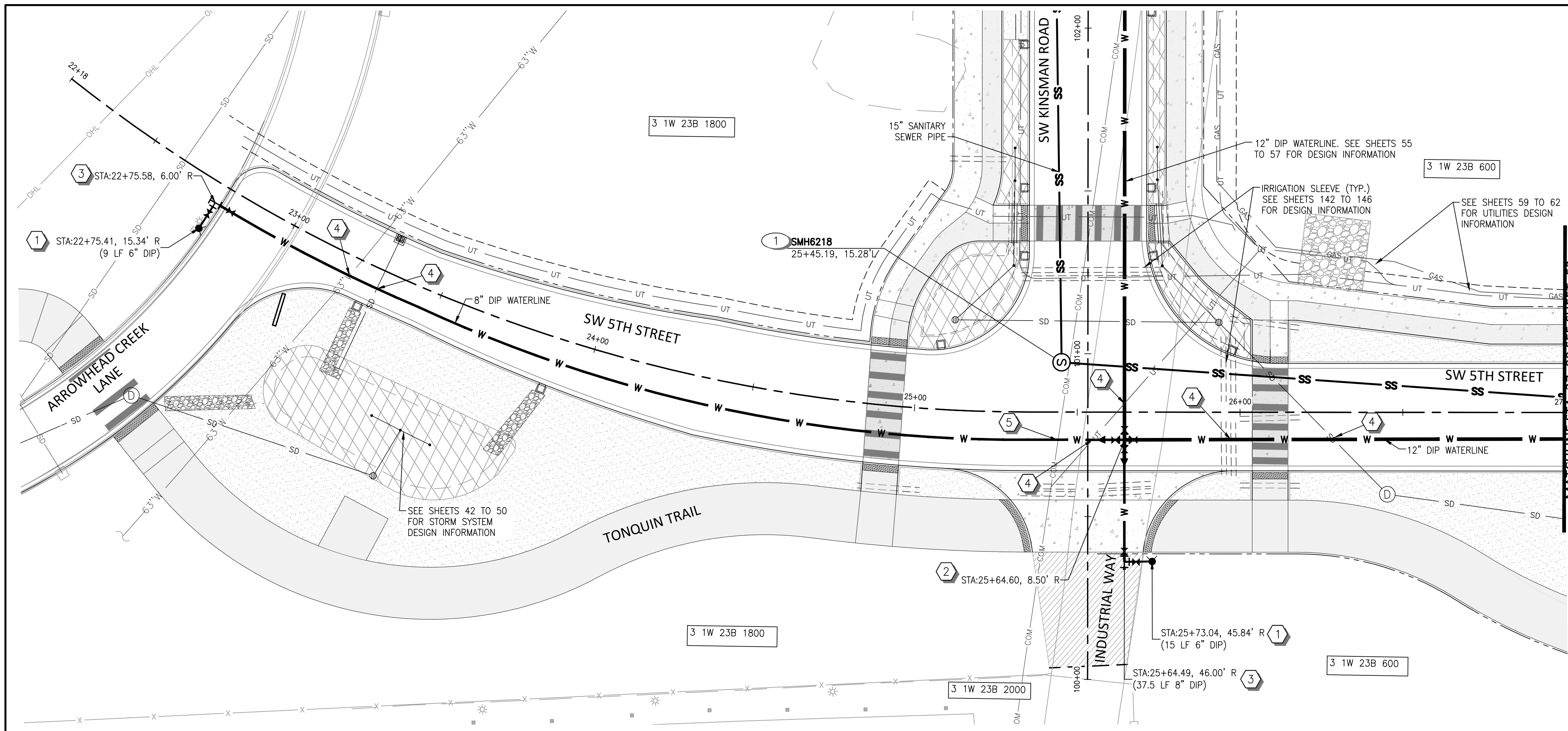

- ### WATER NOTES
- 1 INSTALL FIRE HYDRANT ASSEMBLY. SEE CITY OF WILSONVILLE STD. DETAIL WT-3060 ON SHEET 130. LENGTH OF PIPE IN PARENTHESIS.
 - 2 INSTALL (1) DIP CROSS, 12"x12" (FLG), (4) 12" BUTTERFLY VALVE (FLG X MJ), (2) 12"x8" DIP REDUCER (FLG) ON SOUTH AND WEST ARMS.
 - 3 INSTALL (1) DIP TEE, 8"x6" (FLG), LENGTH OF PIPE TO THE SOUTH IN PARENTHESIS. (1) 8" GATE VALVE (FLG X MJ), (1) 6" GATE VALVE (FLG X MJ), (1) 8" BLIND FLG
 - 4 UTILITY CROSSING. MAINTAIN MIN. 18" OF VERTICAL SEPARATION FOR WATER AND SANITARY SEWER LINES, AND 6" MIN. OF VERTICAL SEPARATION FOR ALL OTHER UTILITIES.
 - 5 EXISTING UTILITY WILL BE ABANDONED.

- ### SANITARY SEWER NOTES
- 1 INSTALL STANDARD MANHOLE, 48". SEE CITY OF WILSONVILLE STD. DETAIL S-2005 ON SHEET 126.

- ### GENERAL NOTES
1. ALL UTILITIES MARKED WITH AN ASTERISK (*) IN PROFILE HAVE AN UNKNOWN DEPTH. CONTRACTOR TO FIELD VERIFY AND PROTECT EXISTING UTILITIES CROSSING. NOTIFY ENGINEER IF CONFLICTS EXIST.
 2. ROTATE MANHOLE CONES SO THAT LIDS ARE LOCATED OUTSIDE OF WHEEL PATHS.
 3. PLUG OPEN END OF WATERLINE WHEN NOT BEING WORKED ON.

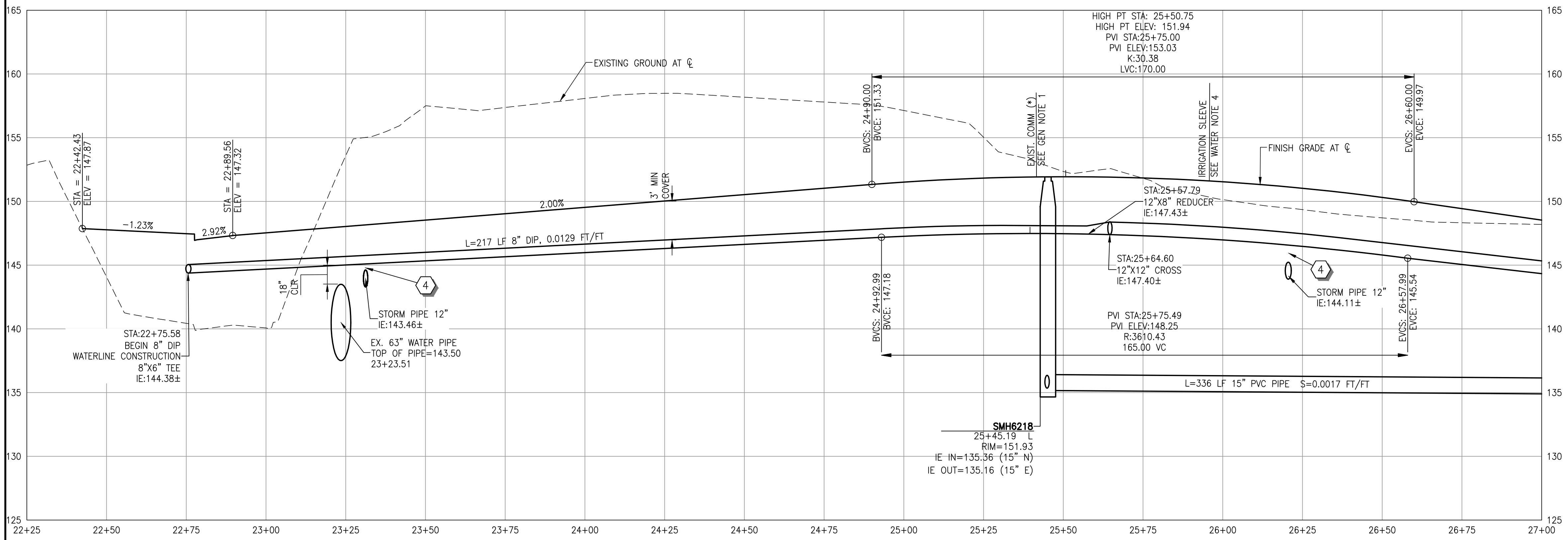

NO.	DESCRIPTION	DATE

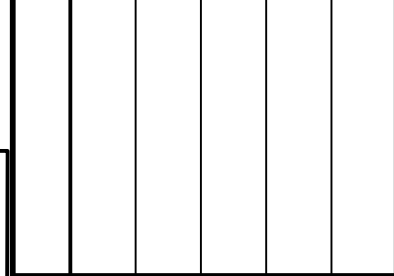

City of Wilsonville
 Engineering Department
 29799 SW Town Center Loop E
 Wilsonville, OR 97070
 Phone 503-682-4960

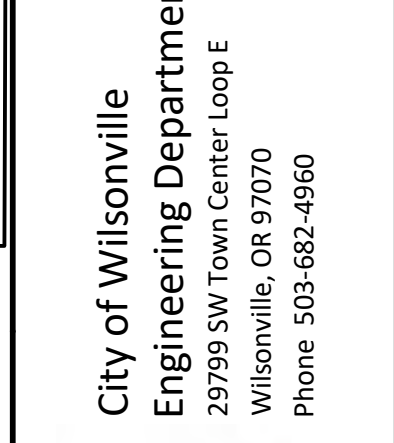

Date: 20 NOVEMBER 2020
 Scale: AS SHOWN
 Designed By: PH/BB
 Drawn By: EID
 Checked By: S.DREHER

PROJECT # 2017-02-001
 UT01
 51 of 213



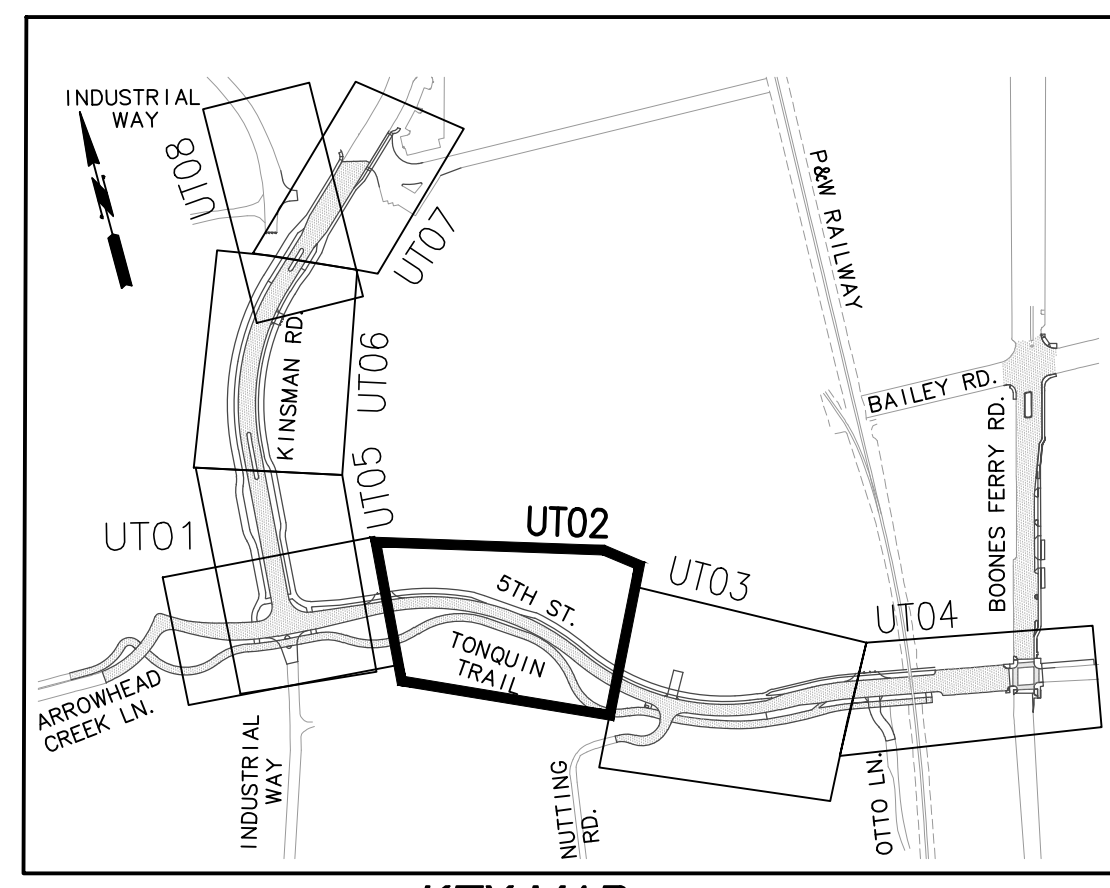
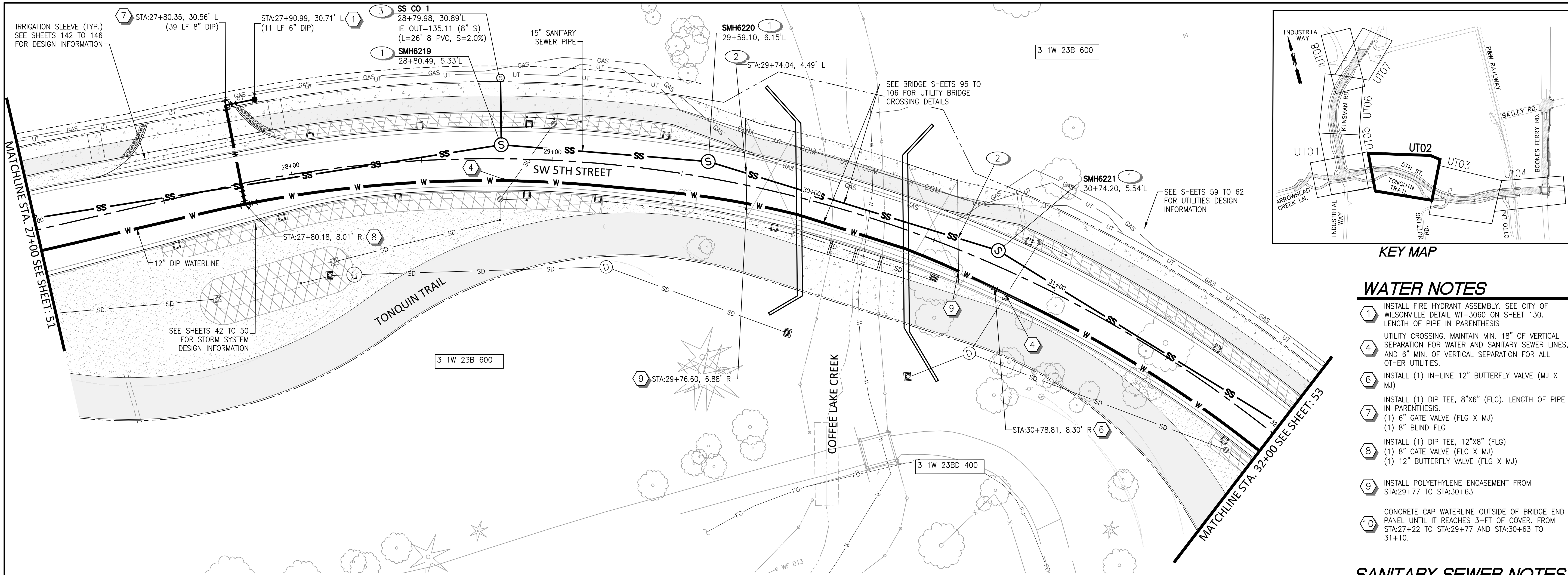

WATER NOTES

- 1. INSTALL FIRE HYDRANT ASSEMBLY. SEE CITY OF WILSONVILLE DETAIL WT-3060 ON SHEET 130. LENGTH OF PIPE IN PARENTHESIS.
- 4. UTILITY CROSSING. MAINTAIN MIN. 18" OF VERTICAL SEPARATION FOR WATER AND SANITARY SEWER LINES, AND 6" MIN. OF VERTICAL SEPARATION FOR ALL OTHER UTILITIES.
- 6. INSTALL (1) IN-LINE 12" BUTTERFLY VALVE (MJ X MJ)
- 7. INSTALL (1) DIP TEE, 8"x6" (FLG). LENGTH OF PIPE IN PARENTHESIS.
(1) 6" GATE VALVE (FLG X MJ)
(1) 8" BLIND FLG
- 8. INSTALL (1) DIP TEE, 12"x8" (FLG)
(1) 8" GATE VALVE (FLG X MJ)
(1) 12" BUTTERFLY VALVE (FLG X MJ)
- 9. INSTALL POLYETHYLENE ENCASEMENT FROM STA:29+77 TO STA:30+63
- 10. CONCRETE CAP WATERLINE OUTSIDE OF BRIDGE END PANEL UNTIL IT REACHES 3-FT OF COVER. FROM STA:27+22 TO STA:29+77 AND STA:30+63 TO 31+10.

SANITARY SEWER NOTES

- 1. INSTALL STANDARD MANHOLE, 48". SEE CITY OF WILSONVILLE STD. DETAIL S-2005 ON SHEET 126
- 2. INSTALL 30" STEEL CASING FROM STA:29+74 TO STA:30+58. SEE PROFILE ON THIS SHEET
- 3. INSTALL STANDARD CLEANOUT. SEE CITY OF WILSONVILLE STD. DETAIL S-2180 ON SHEET 127. LENGTH OF PIPE IN PARENTHESIS.

GENERAL NOTES

- 1. ALL UTILITIES MARKED WITH AN ASTERISK (*) IN PROFILE HAVE AN UNKNOWN DEPTH. CONTRACTOR TO FIELD VERIFY AND PROTECT EXISTING UTILITIES CROSSING. NOTIFY ENGINEER IF CONFLICTS EXIST.
- 2. ROTATE MANHOLE CONES SO THAT LIDS ARE LOCATED OUTSIDE OF WHEEL PATHS.
- 3. PLUG OPEN END OF WATERLINE WHEN NOT BEING WORKED ON.

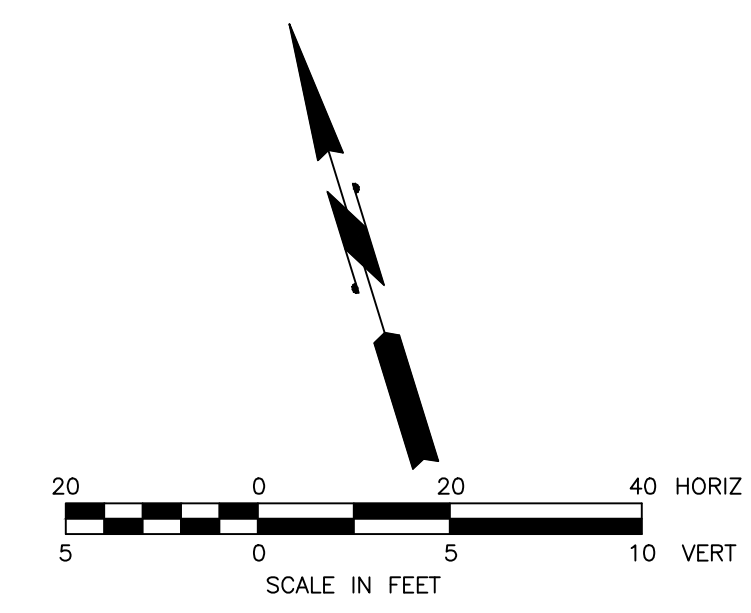
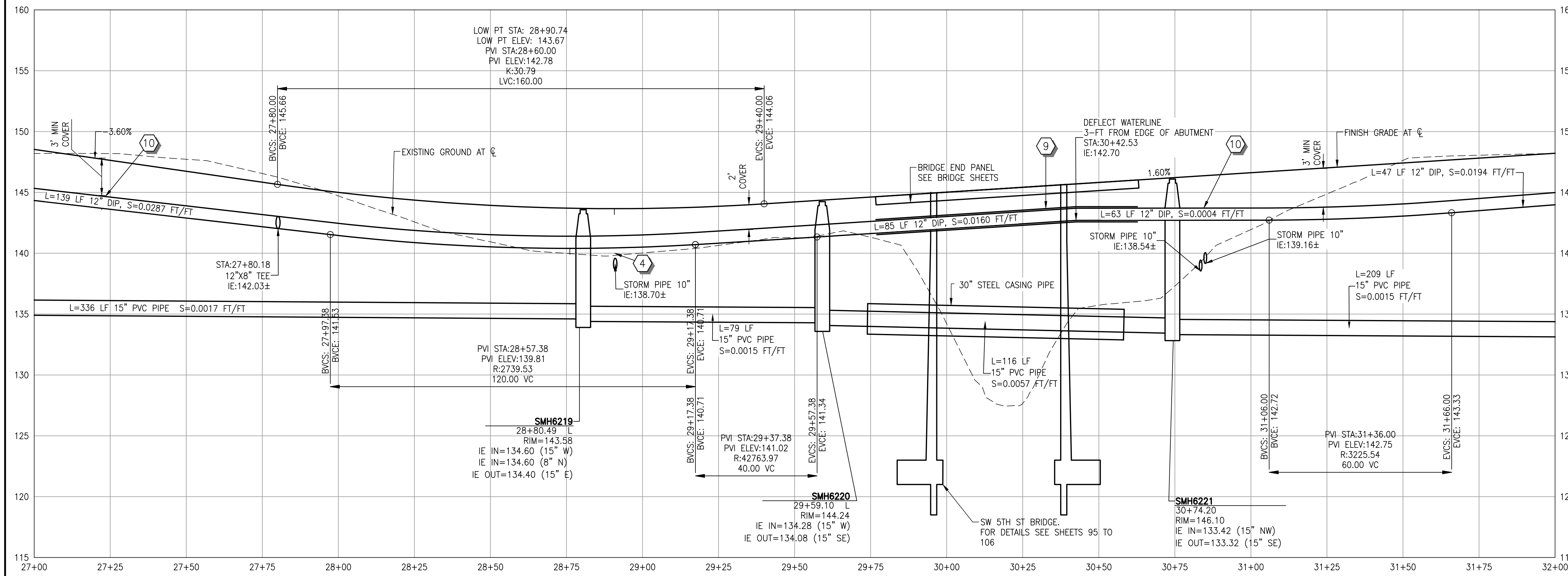

REVISIONS

NO.	DESCRIPTION

REGISTERED PROFESSIONAL ENGINEER
92213PE
OREGON
MAY 09, 2017
PHILLIP JEFFREY HYMUS
RENEWS: 06-30-2021

City of Wilsonville
Engineering Department
29799 SW Town Center Loop E
Wilsonville, OR 97070
Phone 503-682-4960



Date: 20 NOVEMBER 2020
Scale: AS SHOWN
Designed By: PH/BB
Drawn By: EID
Checked By: S.DREHER

**SW 5TH ST TO SW KINSMAN RD EXTENSION
5TH ST - SEWER AND WATER
PLAN AND PROFILE**

CIP # 4196
PROJECT # 2017-02-001
UT02
52 of 213

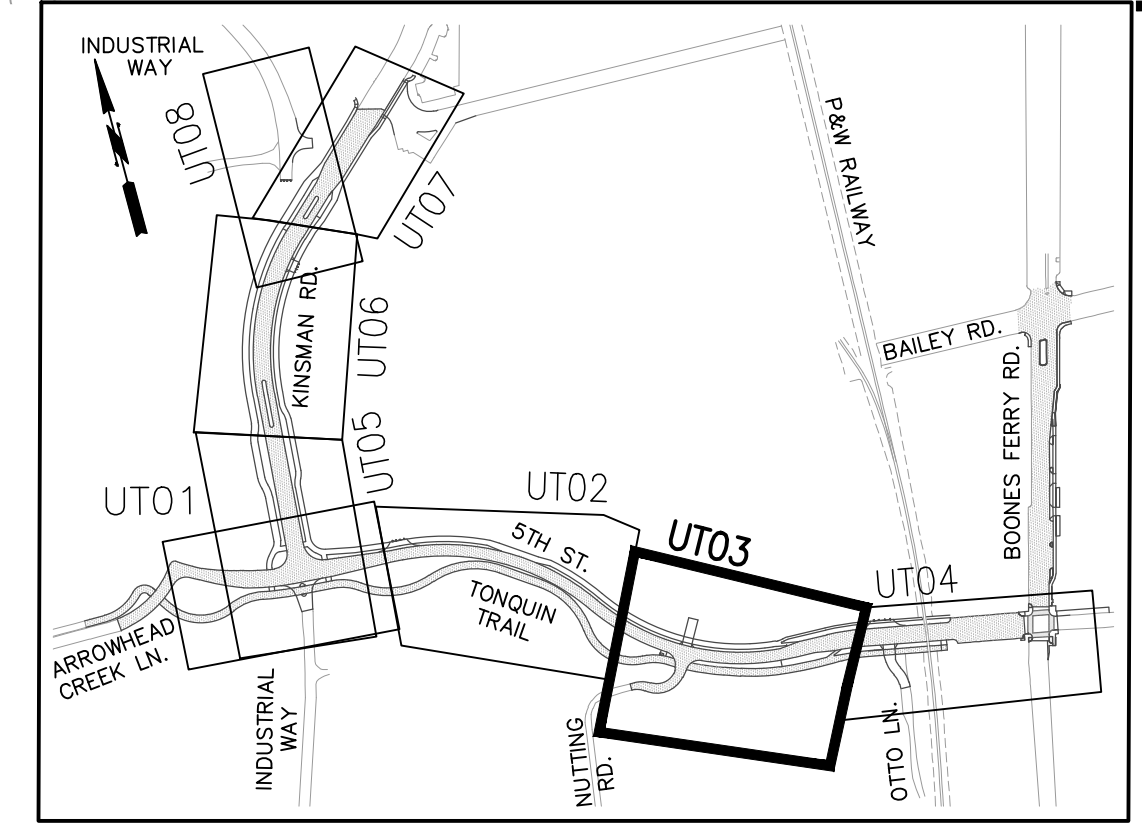
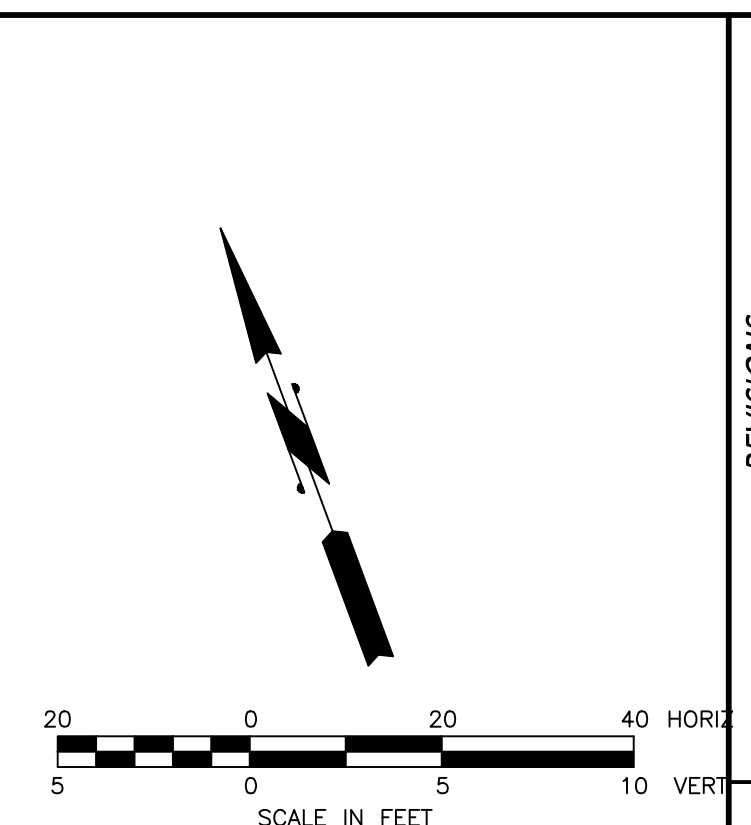
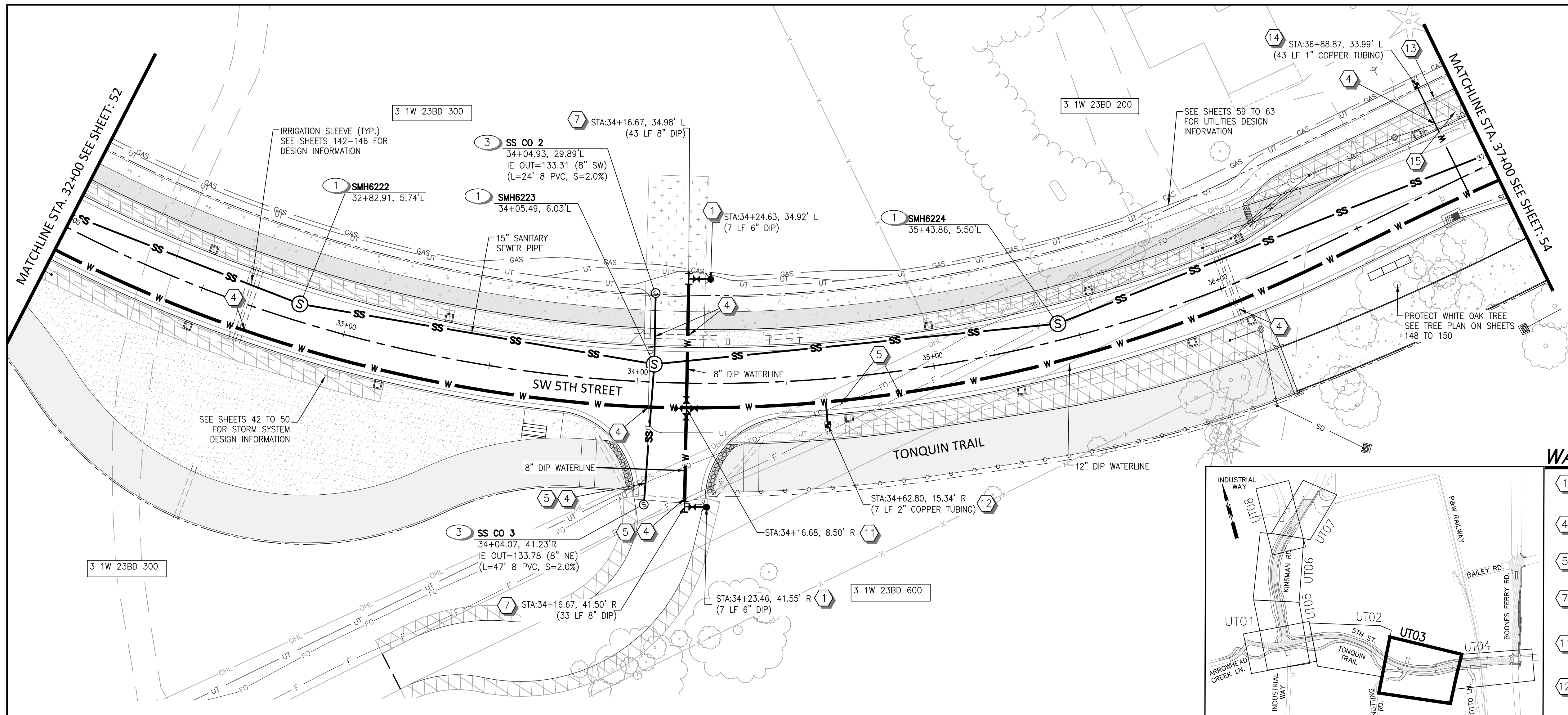

WATER NOTES

- 1 INSTALL FIRE HYDRANT ASSEMBLY. SEE CITY OF WILSONVILLE DETAIL WT-3060 ON SHEET 130. LENGTH OF PIPE IN PARENTHESIS
- 4 UTILITY CROSSING. MAINTAIN MIN. 18" OF VERTICAL SEPARATION FOR WATER AND SANITARY SEWER LINES, AND 6" MIN. OF VERTICAL SEPARATION FOR ALL OTHER UTILITIES.
- 5 EXISTING UTILITY WILL BE ABANDONED.
- 7 INSTALL (1) DIP TEE, 8"x6" (FLG). LENGTH OF PIPE IN PARENTHESIS.
(1) 6" GATE VALVE (FLG X MJ)
(1) 8" BLIND FLG
- 11 INSTALL (1) DIP CROSS, 12"x8" (FLG)
(2) 12" BUTTERFLY VALVE (FLG X MJ)
(2) 8" GATE VALE (FLG X MJ)
- 12 INSTALL 2" SINGLE SERVICE WITH 1 1/2" METER FOR IRRIGATION SYSTEM. SEE CITY OF WILSONVILLE DETAILS WT-3045 & WT-3050 ON SHEET 130. LENGTH OF PIPE IN PARENTHESIS.

KEY MAP

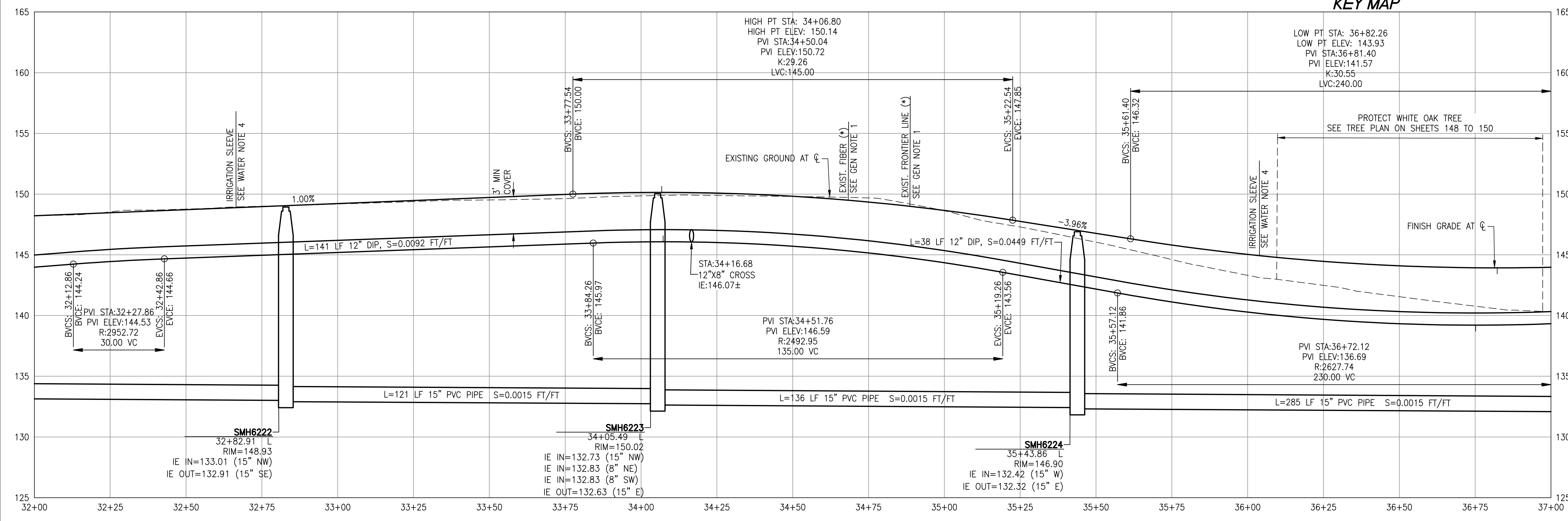

- 13 RELOCATE 3/4" WATER METER ASSEMBLY AS SHOWN. NOTIFY AFFECTED CUSTOMER OF SERVICE INTERRUPTION AT LEAST 24 HOURS PRIOR TO SERVICE INTERRUPTION.
- 14 INSTALL 1" COPPER SERVICE LINE. LENGTH OF COPPER TUBING IN PARENTHESIS. CONTRACTOR TO VERIFY EXISTING METER SIZE AND CONTACT ENGINEER IF CONFLICT EXISTS. SEE CITY OF WILSONVILLE STD DETAIL WT-3030 & WT-3036 ON SHEET 132.
- 15 ABANDON WATERLINE AFTER NEW WATERLINE IS INSTALLED, TESTED, AND APPROVED BY THE CITY.

SANITARY SEWER NOTES

- 1 INSTALL STANDARD MANHOLE, 48". SEE CITY OF WILSONVILLE STD. DETAIL S-2005 ON SHEET 126
- 3 INSTALL STANDARD CLEANOUT. SEE CITY OF WILSONVILLE STD. DETAIL S-2180 ON SHEET 127. LENGTH OF PIPE IN PARENTHESIS.

GENERAL NOTES

- 1. ALL UTILITIES MARKED WITH AN ASTERISK (*) IN PROFILE HAVE AN UNKNOWN DEPTH. CONTRACTOR TO FIELD VERIFY AND PROTECT EXISTING UTILITIES CROSSING. NOTIFY ENGINEER IF CONFLICTS EXIST.
- 2. ROTATE MANHOLE CONES SO THAT LIDS ARE LOCATED OUTSIDE OF WHEEL PATHS.
- 3. PLUG OPEN END OF WATERLINE WHEN NOT BEING WORKED ON.



REVISIONS

REGISTERED PROFESSIONAL ENGINEER
92213PE
OREGON
MAY 09, 2017
PHILLIP JEFFREY HYMUS
RENEWS: 06-30-2021

City of Wilsonville
Engineering Department
29799 SW Town Center Loop E
Wilsonville, OR 97070
Phone 503-682-4960

Date: 20 NOVEMBER 2020
Scale: AS SHOWN
Designed By: PH/BB
Drawn By: EID
Checked By: S.DREHER

**SW 5TH ST TO SW KINSMAN RD EXTENSION
5TH ST - SEWER AND WATER
PLAN AND PROFILE**

CIP# 4196
PROJECT# 2017-02-001
UT03
53 of 213

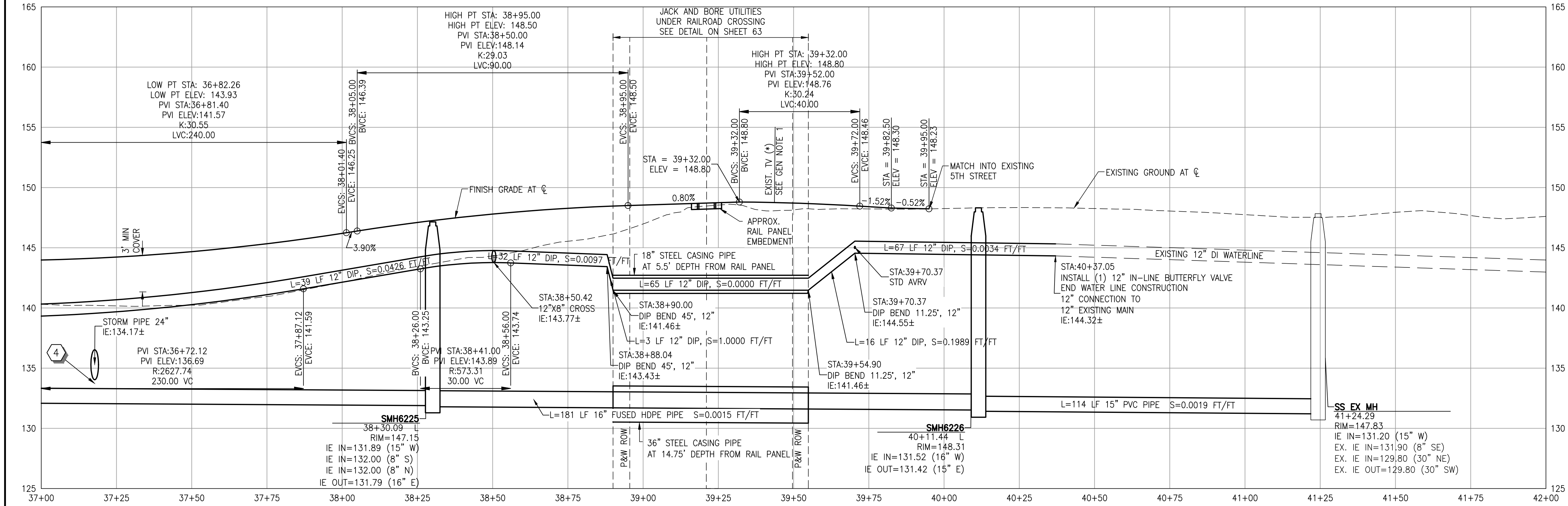
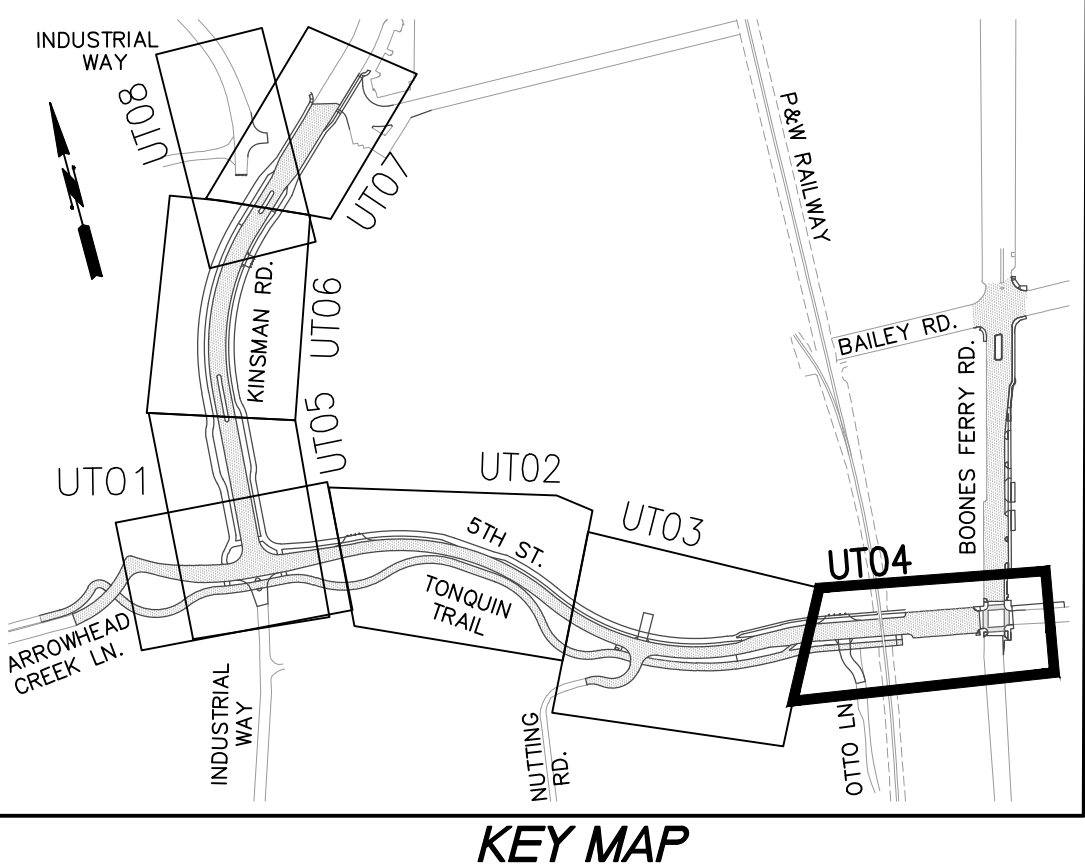
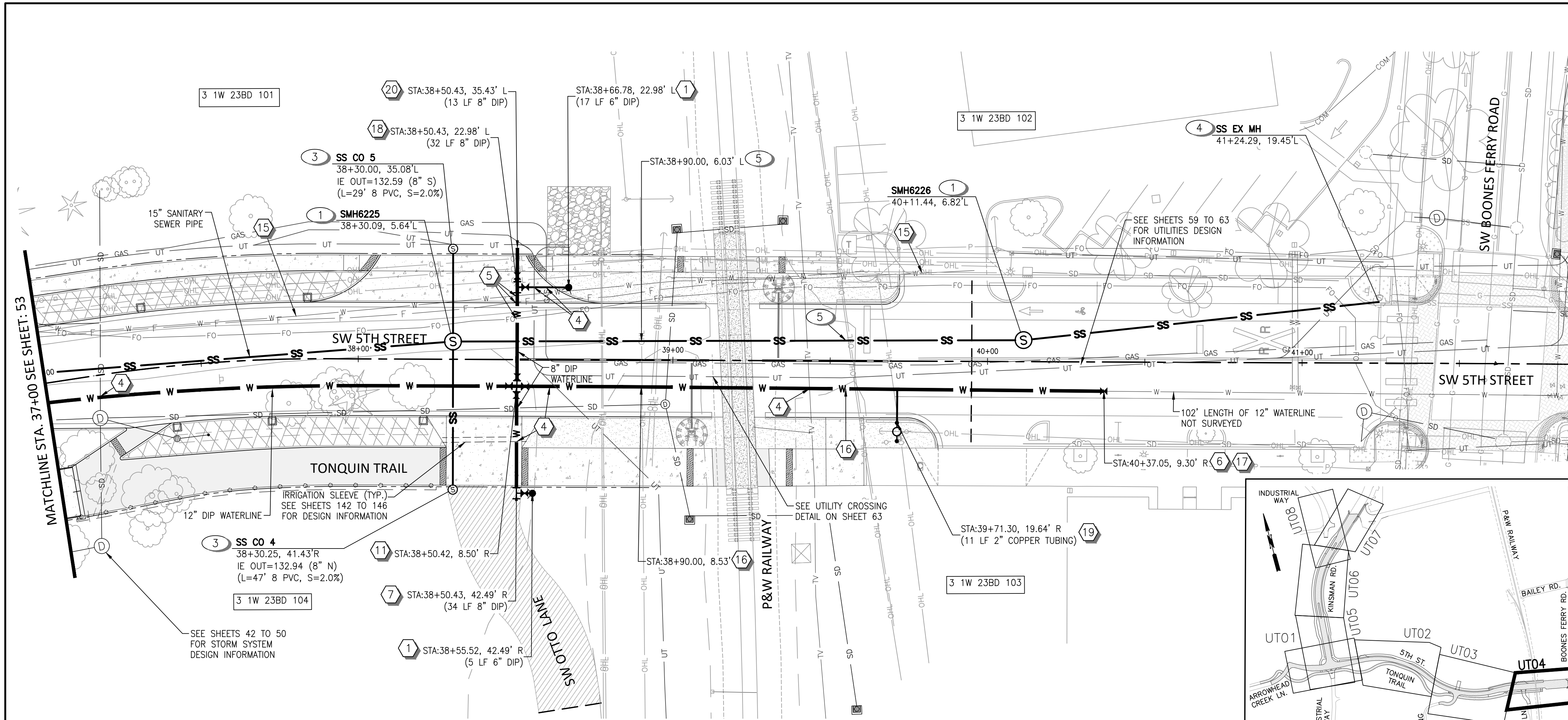

WATER NOTES

- 1 INSTALL FIRE HYDRANT ASSEMBLY. SEE CITY OF WILSONVILLE DETAIL WT-3060 ON SHEET 130. LENGTH OF PIPE IN PARENTHESIS
- 4 UTILITY CROSSING. MAINTAIN MIN. 18" OF VERTICAL SEPARATION FOR WATER AND SANITARY SEWER LINES, AND 6" MIN. OF VERTICAL SEPARATION FOR ALL OTHER UTILITIES.
- 5 EXISTING UTILITY WILL BE ABANDONED.
- 6 INSTALL (1) 12" IN-LINE BUTTERFLY VALVE (MJ X MJ)
- 7 INSTALL (1) DIP TEE, 8"x6" (FLG). LENGTH OF PIPE IN PARENTHESIS.
(1) 6" GATE VALVE (FLG X MJ)
(1) 8" BLIND FLG
- 11 INSTALL (1) DIP CROSS, 12"x8" (FLG)
(2) 12" FLG X MJ BUTTERFLY VALVE
(2) 8" FLG X MJ GATE VALVE
- 15 ABANDON WATERLINE AFTER NEW WATERLINE IS INSTALLED, TESTED, AND APPROVED BY THE CITY.
- 16 INSTALLING 18" PIPE UNDER RAILROAD FROM STA:38+90 TO STA:39+55. SEE PROFILE ON THIS SHEET.
- 17 12" CONNECTION TO 12" EXISTING MAIN. LOCATION APPROXIMATE. CONTRACTOR TO FIELD VERIFY EXISTING WATERLINE LOCATION & INVERT ELEVATION. CONTACT ENGINEER IF CONFLICT EXISTS.
- 18 INSTALL (1) DIP TEE, 8"x6" (FLG). LENGTH OF PIPE IN PARENTHESIS.
(1) 8" GATE VALVE (FLG X MJ)
(1) 6" GATE VALVE (FLG X MJ)
- 19 INSTALL (1) STANDARD AIR AND VACUUM RELEASE VALVE. SEE CITY OF WILSONVILLE STD. DETAIL WT-3090 ON SHEET 128. TAP 12" WATERLINE AT HIGH POINT, APPROX STA:39+70
- 20 INSTALL (1) 8" MJ PLUG. LENGTH OF PIPE IN PARENTHESIS.

GENERAL NOTES

1. ALL UTILITIES MARKED WITH AN ASTERISK (*) IN PROFILE HAVE AN UNKNOWN DEPTH. CONTRACTOR TO FIELD VERIFY AND PROTECT EXISTING UTILITIES CROSSING. NOTIFY ENGINEER IF CONFLICTS EXIST.
2. ROTATE MANHOLE CONES SO THAT LIDS ARE LOCATED OUTSIDE OF WHEEL PATHS.
3. PLUG OPEN END OF WATERLINE WHEN NOT BEING WORKED ON.

SANITARY SEWER NOTES

- 1 INSTALL STANDARD MANHOLE, 48". SEE CITY OF WILSONVILLE STD. DETAIL S-2005 ON SHEET 126.
- 3 INSTALL STANDARD CLEANOUT. SEE CITY OF WILSONVILLE STD. DETAIL S-2180 ON SHEET 127. LENGTH OF PIPE IN PARENTHESIS.
- 4 CONNECT TO EXISTING STRUCTURE. SEE PROFILE ON THIS SHEET. COORDINATE WITH CITY FOR PUMP BY-PASS AND CONNECTION.
- 5 INSTALLING 36" PIPE UNDER RAILROAD FROM STA:38+90 TO STA:39+55. SEE PROFILE ON THIS SHEET.

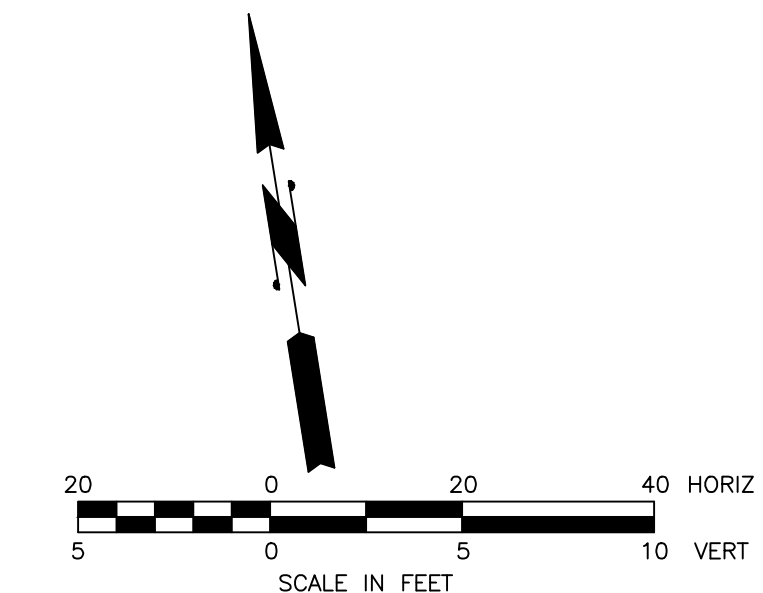

NO.	REVISIONS



OREGON
MAY 09, 2017
RENEWALS: 06-30-2021

City of Wilsonville
Engineering Department
29799 SW Town Center Loop E
Wilsonville, OR 97070
Phone 503-682-4960



Date: 20 NOVEMBER 2020
Scale: AS SHOWN
Designed By: PH/BB
Drawn By: EID
Checked By: S.DREHER

SW 5TH ST TO SW KINSMAN RD EXTENSION
 5TH ST - SEWER AND WATER
 PLAN AND PROFILE

CIP# 4196
PROJECT# 2017-02-001
UT04
54 of 213

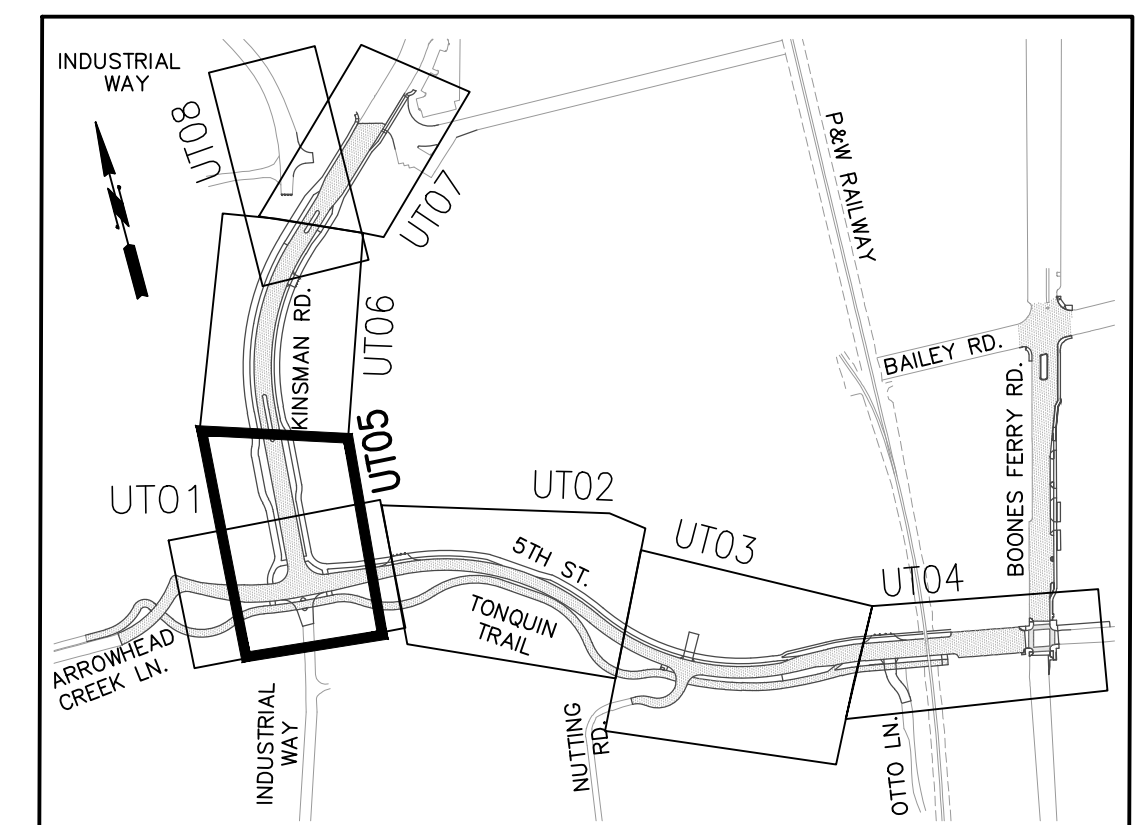
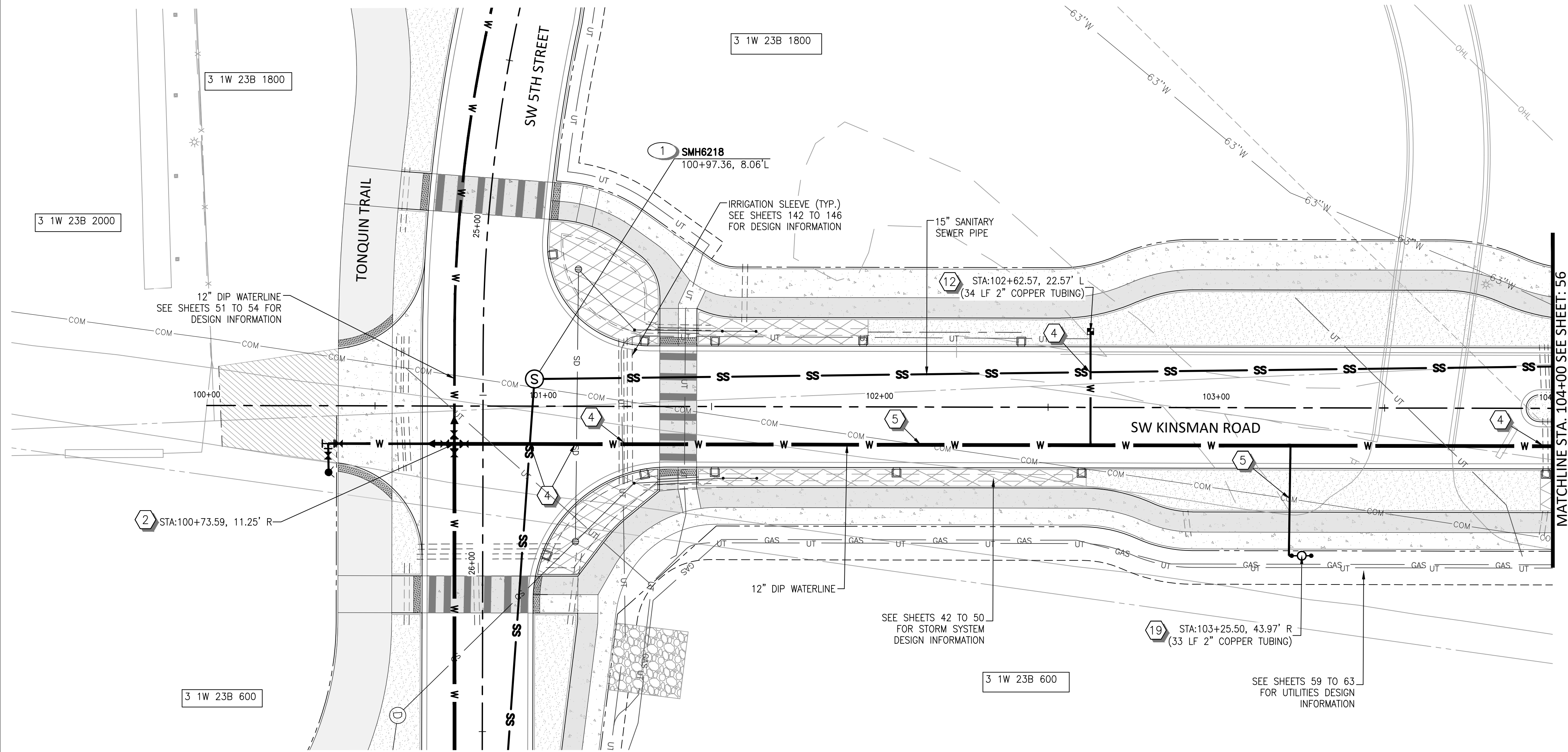

WATER NOTES

- (2) INSTALL (1) DIP CROSS, 12"x12" (FLG), LENGTH OF PIPE TO THE SOUTH IN PARENTHESIS.
- (4) 12" BUTTERFLY VALVE (FLG X MJ)
- (2) 12"x8" DIP REDUCER (FLG) ON SOUTH AND WEST ARMS.
- (4) UTILITY CROSSING. MAINTAIN MIN. 18" OF VERTICAL SEPARATION FOR WATER AND SANITARY SEWER LINES, AND 6" MIN. OF VERTICAL SEPARATION FOR ALL OTHER UTILITIES.
- (5) EXISTING UTILITY WILL BE ABANDONED.
- (12) INSTALL 2" SINGLE SERVICE WITH 1 1/2" METER FOR IRRIGATION SYSTEM. SEE CITY OF WILSONVILLE DETAILS WT-3045 & WT-3050 ON SHEET 130. LENGTH OF PIPE IN PARENTHESIS
- (19) INSTALL (1) STANDARD AIR AND VACUUM RELEASE VALVE. SEE CITY OF WILSONVILLE STD. DETAIL WT-3090 ON SHEET 130. TAP 12" WATERLINE AT HIGH POINT, APPROX. STA:103+22.

SANITARY SEWER NOTES

- (1) INSTALL STANDARD MANHOLE, 48". SEE CITY OF WILSONVILLE STD. DETAIL S-2005 ON SHEET 126.

GENERAL NOTES

1. ALL UTILITIES MARKED WITH AN ASTERISK (*) IN PROFILE HAVE AN UNKNOWN DEPTH. CONTRACTOR TO FIELD VERIFY AND PROTECT EXISTING UTILITIES CROSSING. NOTIFY ENGINEER IF CONFLICTS EXIST.
2. ROTATE MANHOLE CONES SO THAT LIDS ARE LOCATED OUTSIDE OF WHEEL PATHS.
3. PLUG OPEN END OF WATERLINE WHEN NOT BEING WORKED ON.

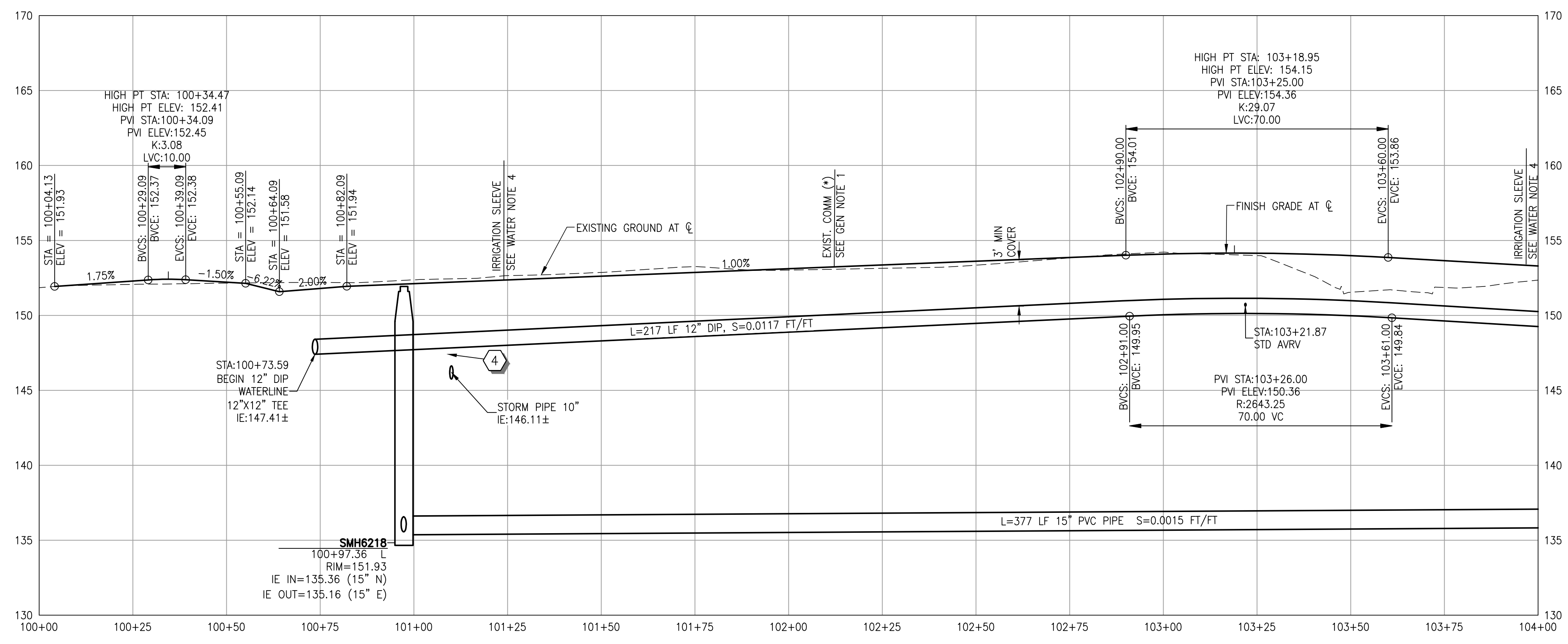

REVISIONS

REGISTERED PROFESSIONAL ENGINEER
92213PE
OREGON
MAY 09, 2017
PHILLIP JEFFREY HYMUS
RENEWS: 06-30-2021

City of Wilsonville
Engineering Department
29799 SW Town Center Loop E
Wilsonville, OR 97070
Phone 503-682-4960

Date: 20 NOVEMBER 2020
Scale: AS SHOWN
Designed By: PH/BB
Drawn By: SLR
Checked By: S.DREHER

SW 5TH ST TO SW KINSMAN RD EXTENSION
KINSMAN RD - SEWER AND WATER

CIP # 4196
PROJECT # 2017-02-001
UT05
55 of 213

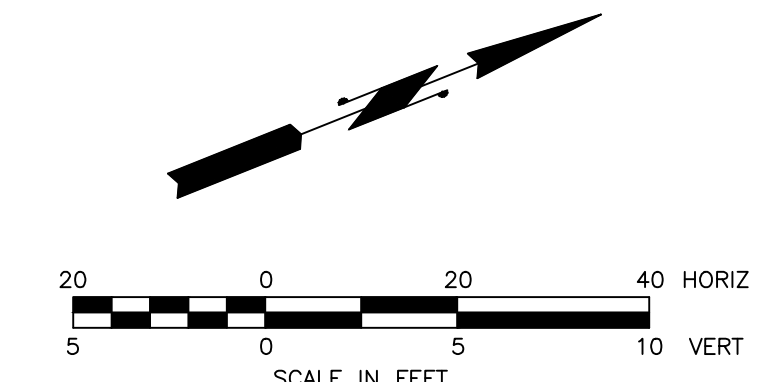
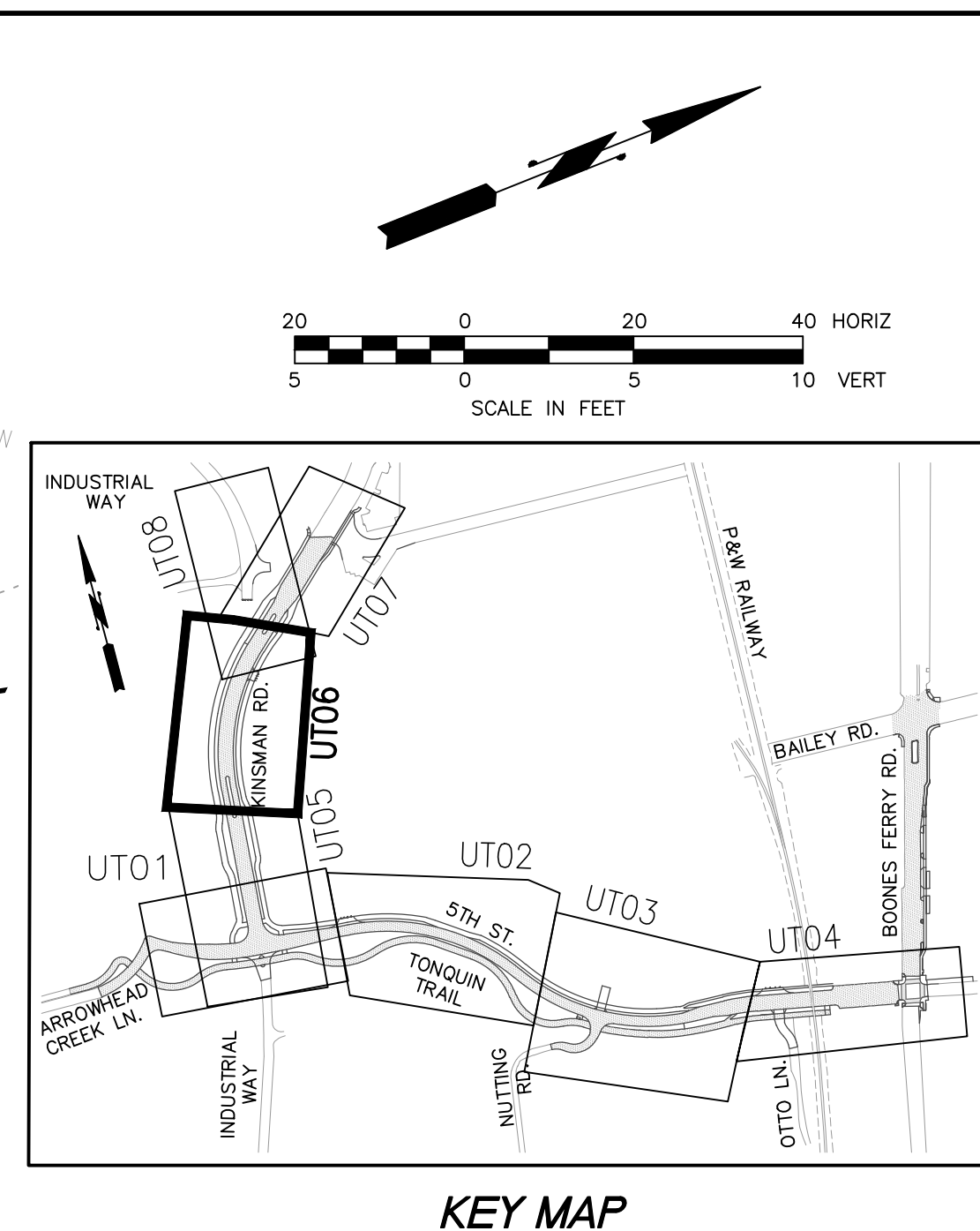
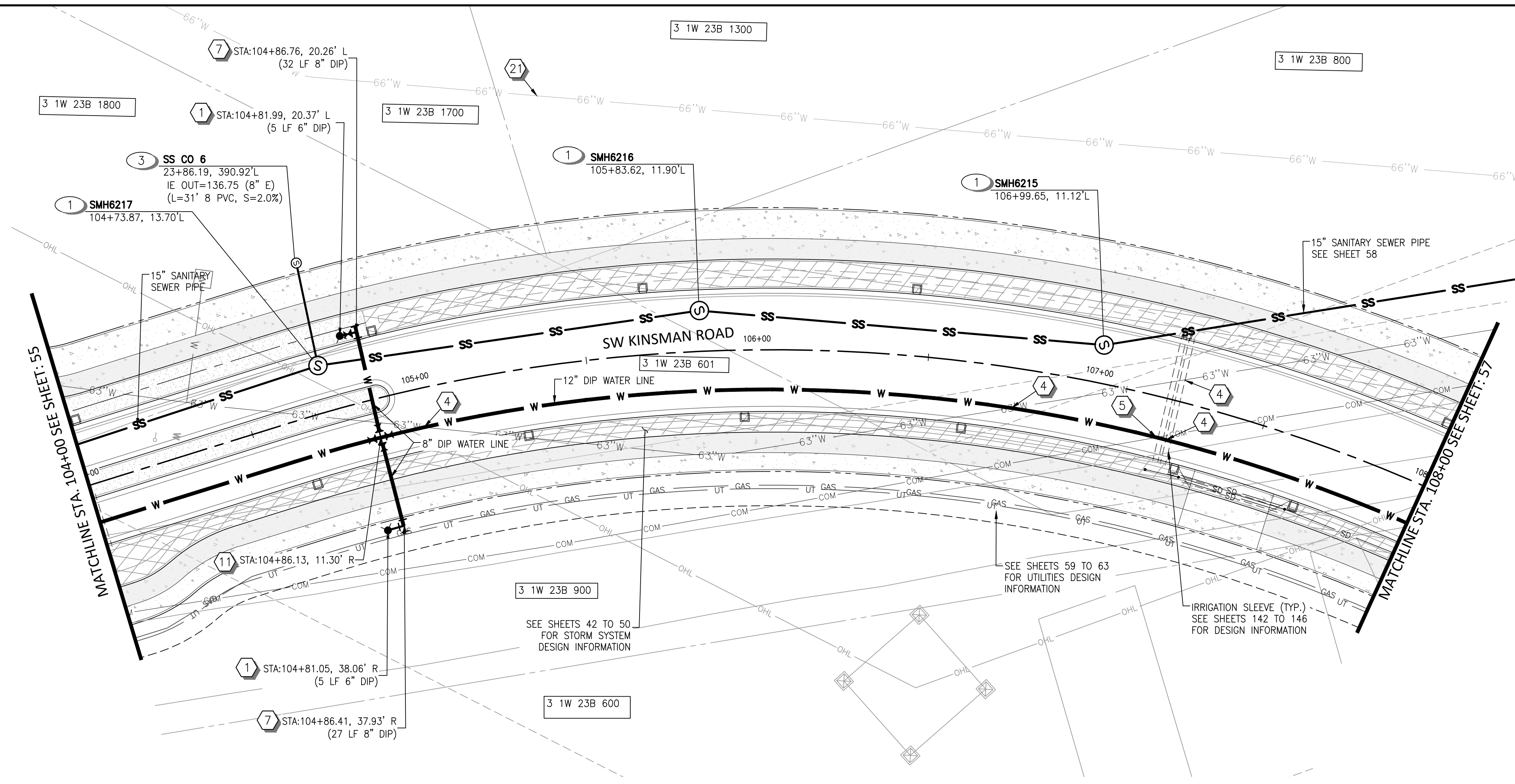

- ### WATER NOTES
- 1 INSTALL FIRE HYDRANT ASSEMBLY. SEE CITY OF WILSONVILLE DETAIL WT-3060 ON SHEET 130. LENGTH OF PIPE IN PARENTHESIS
 - 4 UTILITY CROSSING. MAINTAIN MIN. 18" OF VERTICAL SEPARATION FOR WATER AND SANITARY SEWER LINES, AND 6" MIN. OF VERTICAL SEPARATION FOR ALL OTHER UTILITIES.
 - 5 EXISTING UTILITY WILL BE ABANDONED.
 - 7 INSTALL (1) DIP TEE, 8"x6" (FLG) PIPE LENGTH IN PARENTHESIS.
(1) 6" GATE VALVE (FLG X MJ)
(1) 8" BLIND FLG
 - 11 INSTALL (1) DIP CROSS, 12"x8" (FLG)
(2) 12" BUTTERFLY VALVE (FLG X MJ)
(2) 8" GATE VALVE (FLG X MJ)
 - 21 66" WATER LINE. DESIGNED PERFORMED BY OTHERS.

- ### SANITARY SEWER NOTES
- 1 INSTALL STANDARD MANHOLE. 48". SEE CITY OF WILSONVILLE STD. DETAIL S-2005 ON SHEET 126.
 - 3 INSTALL STANDARD CLEANOUT. SEE CITY OF WILSONVILLE STD. DETAIL S-2180 ON SHEET 127. LENGTH OF PIPE IN PARENTHESIS.

- ### GENERAL NOTES
1. ALL UTILITIES MARKED WITH AN ASTERISK (*) IN PROFILE HAVE AN UNKNOWN DEPTH. CONTRACTOR TO FIELD VERIFY AND PROTECT EXISTING UTILITIES CROSSING. NOTIFY ENGINEER IF CONFLICTS EXIST.
 2. ROTATE MANHOLE CONES SO THAT LIDS ARE LOCATED OUTSIDE OF WHEEL PATHS.
 3. PLUG OPEN END OF WATERLINE WHEN NOT BEING WORKED ON.

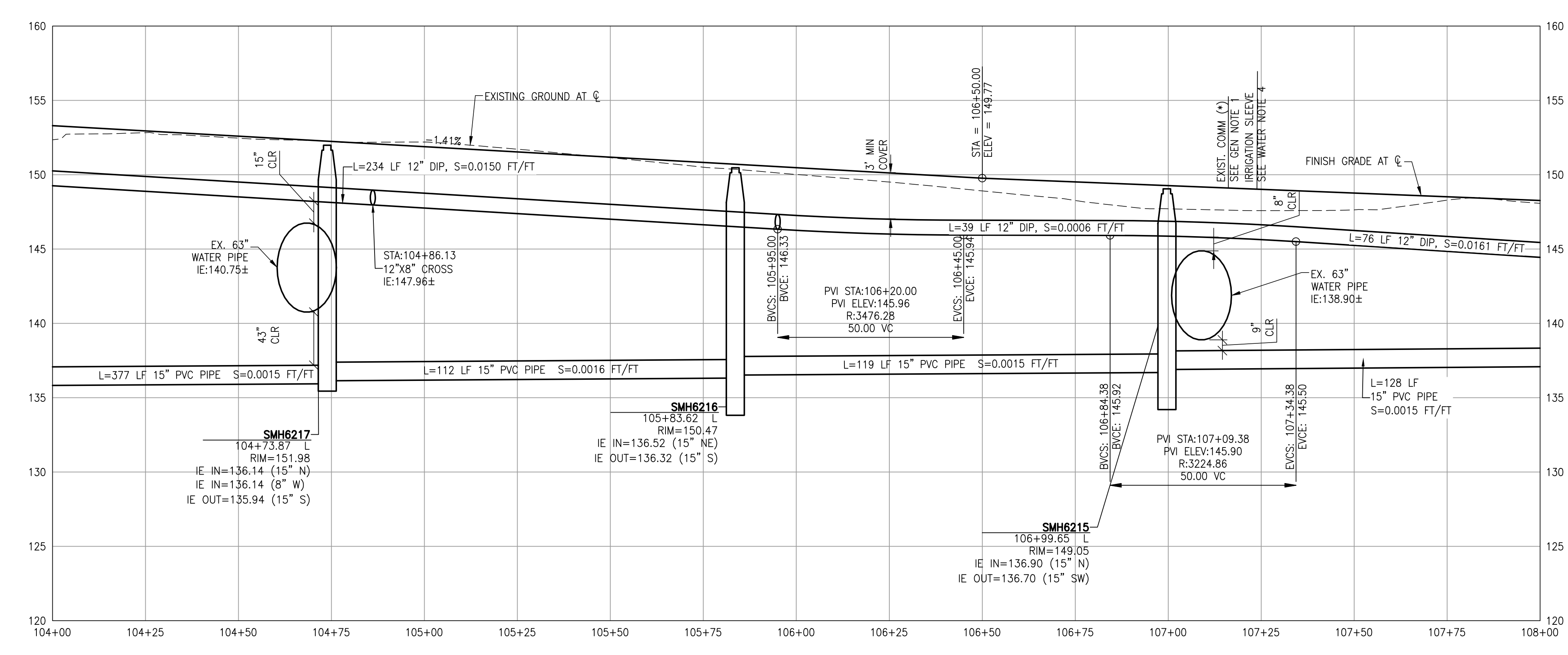

REVISIONS

REGISTERED PROFESSIONAL ENGINEER
92213PE
PHILLIP JEFFREY HYMUS
OREGON
MAY 09, 2017
RENEWS: 06-30-2021

City of Wilsonville
Engineering Department
29799 SW Town Center Loop E
Wilsonville, OR 97070
Phone 503-682-4960

Date: 20 NOVEMBER 2020
Scale: AS SHOWN
Designed By: PH/BB
Drawn By: SLR
Checked By: S.DREHER

**SW 5TH ST TO SW KINSMAN RD EXTENSION
KINSMAN RD - SEWER AND WATER**

CIP# 4196
PROJECT# 2017-02-001
UT06
56 of 213



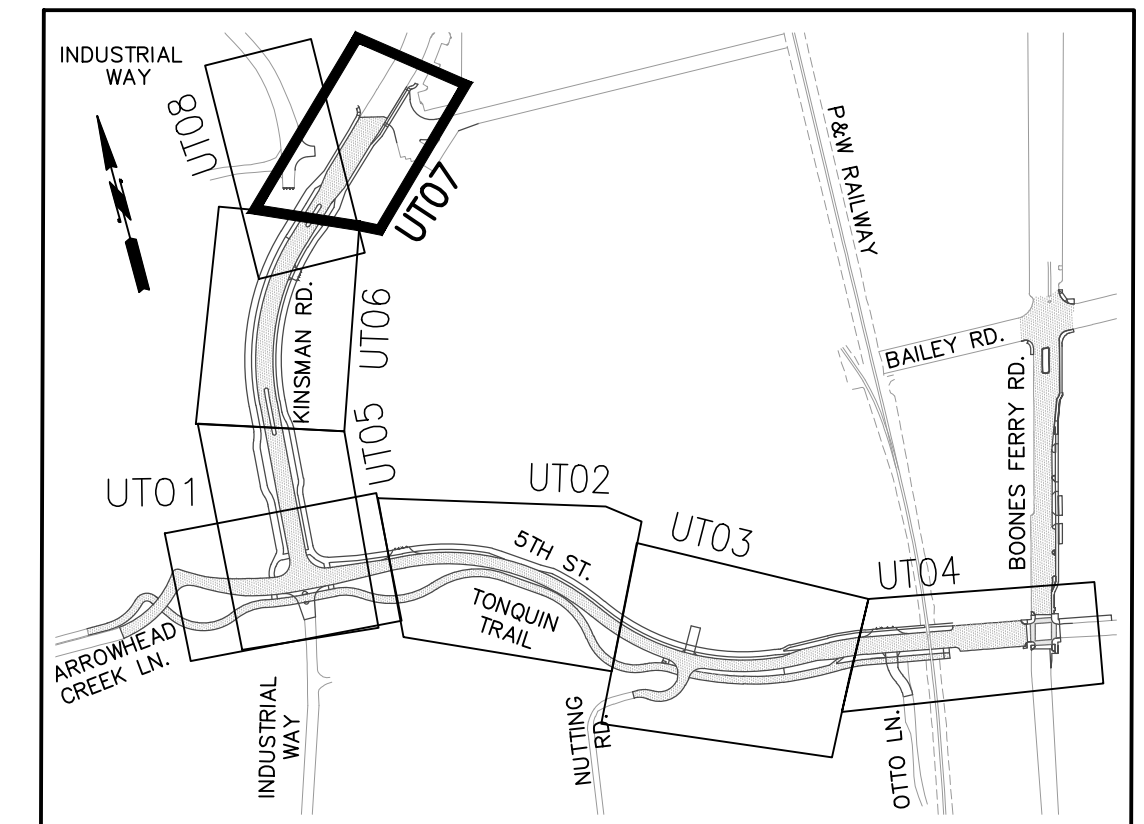
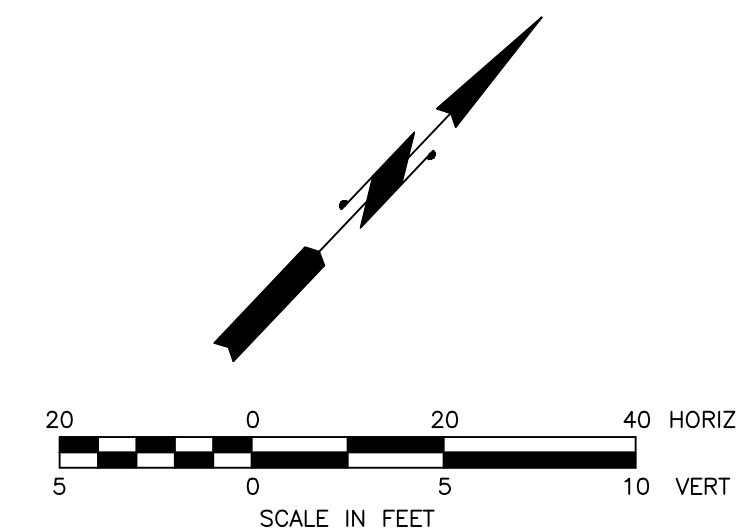
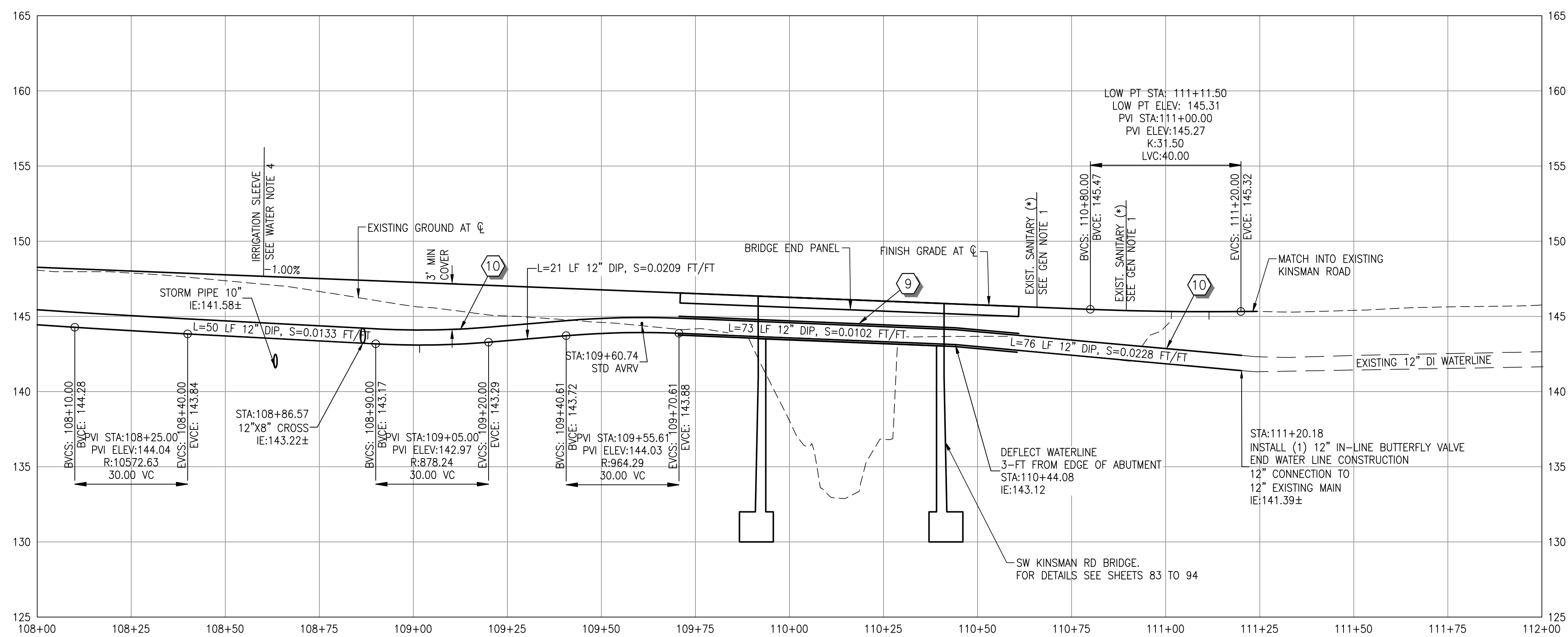
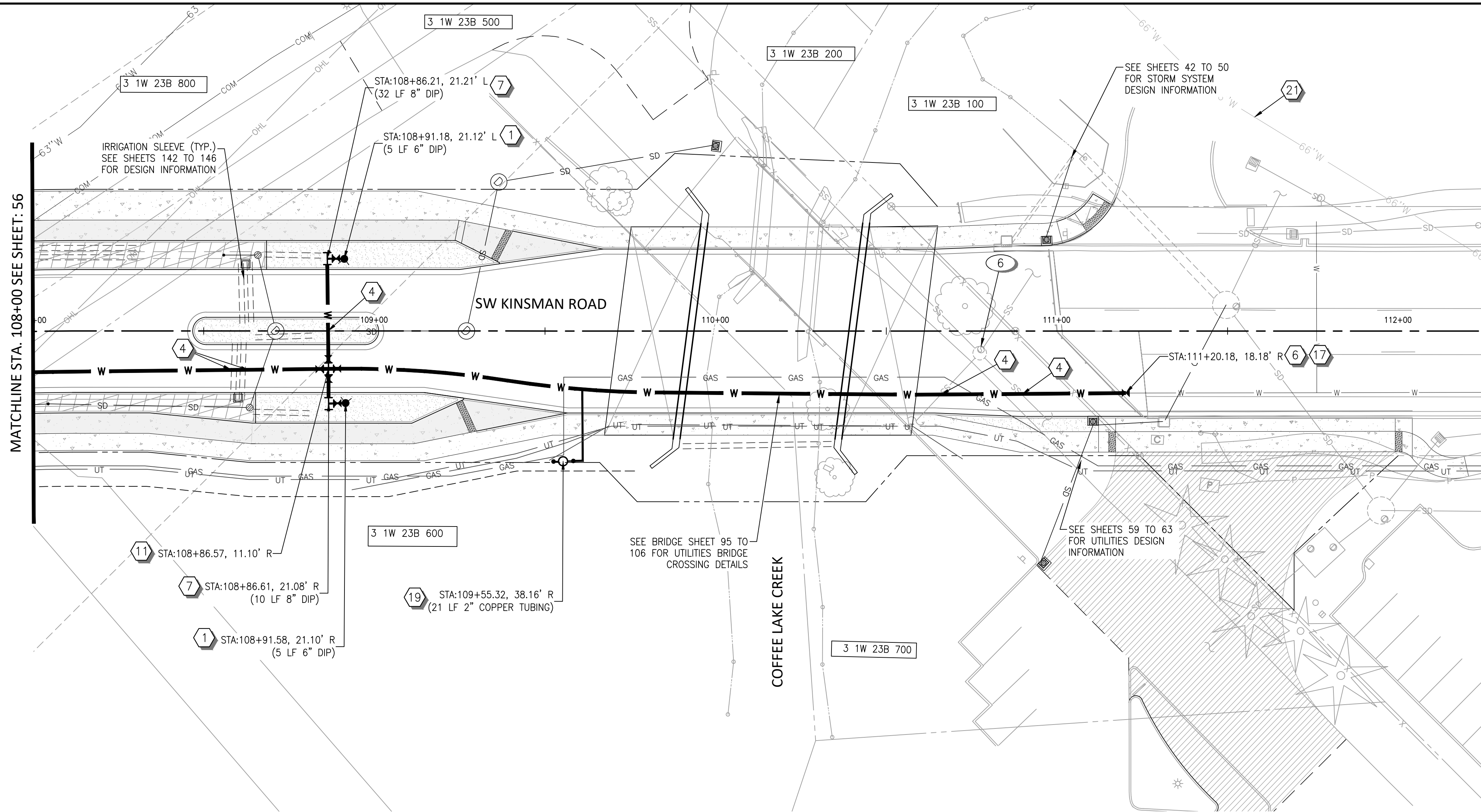

KEY MAP

WATER NOTES

- 1 INSTALL FIRE HYDRANT ASSEMBLY. SEE CITY OF WILSONVILLE DETAIL WT-3060 ON SHEET 130. LENGTH OF PIPE IN PARENTHESIS
- 4 UTILITY CROSSING. MAINTAIN MIN. 18" OF VERTICAL SEPARATION FOR WATER AND SANITARY SEWER LINES, AND 6" MIN. OF VERTICAL SEPARATION FOR ALL OTHER UTILITIES.
- 5 EXISTING UTILITY WILL BE ABANDONED.
- 6 INSTALL (1) 12" IN-LINE BUTTERFLY VALVE (MJ X MJ)
- 7 INSTALL (1) DIP TEE, 8"x6" (FLG). LENGTH OF PIPE IN PARENTHESIS.
(1) 6" GATE VALVE (FLG X MJ)
(1) 8" BLIND FLG
- 9 INSTALL POLYETHYLENE ENCASEMENT FROM STA-109+71 TO STA-110+61
- 10 CONCRETE CAP WATERLINE OUTSIDE OF BRIDGE END PANEL UNTIL IT REACHES 3'-FT OF COVER. FROM STA-109+10 TO STA-109+71 AND STA-110+61 TO 111+20.
- 11 INSTALL (1) DIP CROSS, 12"x8" (FLG)
(2) 12" BUTTERFLY VALVE (FLG X MJ)
(2) 8" GATE VALVE (FLG X MJ)
- 7 12" CONNECTION TO 12" EXISTING MAIN
LOCATION APPROXIMATE. CONTRACTOR TO FIELD VERIFY EXISTING WATERLINE LOCATION & INVERT ELEVATION. CONTACT ENGINEER IF CONFLICT EXISTS.
- 19 INSTALL (1) STANDARD AIR AND VACUUM RELEASE VALVE. SEE CITY OF WILSONVILLE STD. DETAIL WT-3090 ON SHEET 130. TAP 12" WATERLINE AT HIGH POINT, APPROX. STA:109+61.
- 21 66" WATER LINE. DESIGNED PERFORMED BY OTHERS.

SANITARY SEWER NOTES

- 6 ADJUST MANHOLE TO FINISH GRADE, ABANDON PIPE TO THE WEST, FILL PIPE WITH GROUT, AND RE-CHANNEL MANHOLE.

GENERAL NOTES

1. ALL UTILITIES MARKED WITH AN ASTERISK (*) IN PROFILE HAVE AN UNKNOWN DEPTH. CONTRACTOR TO FIELD VERIFY AND PROTECT EXISTING UTILITIES CROSSING. NOTIFY ENGINEER IF CONFLICTS EXIST.
2. ROTATE MANHOLE CONES SO THAT LIDS ARE LOCATED OUTSIDE OF WHEEL PATHS.
3. PLUG OPEN END OF WATERLINE WHEN NOT BEING WORKED ON.

REVISIONS

REGISTERED PROFESSIONAL ENGINEER
922213PE
OREGON
MAY 09, 2017
PHILLIP JEFFREY HYMMS
RENEWS: 06-30-2021

City of Wilsonville
Engineering Department
29799 SW Town Center Loop E
Wilsonville, OR 97070
Phone 503-682-4960



Date: 20 NOVEMBER 2020
Scale: AS SHOWN
Designed By: PH/BB
Drawn By: SLR
Checked By: S.DREHER

SW 5TH ST TO SW KINSMAN RD EXTENSION
KINSMAN RD - SEWER AND WATER

Otak
Otak, Inc.
700 Washington St., Suite 800
Vancouver, WA 98660
360.737.9613
www.otak.com

CIP# 4196
PROJECT# 2017-02-001
UT07
57 of 213

THE URBAN RENEWAL AGENCY OF THE CITY OF WILSONVILLE

URA RESOLUTION NO. 262

A RESOLUTION TO AMEND THE YEAR 2000 URBAN RENEWAL PLAN TO ADD PROPERTY, REMOVE PROPERTY AND ADD A PROJECT, THE TENTH AMENDMENT.

WHEREAS, the Year 2000 Urban Renewal Plan (“Original Plan”) was adopted by the Wilsonville City Council (the “City Council”) on August 29, 1990 by Ordinance No.373 to provide tax increment funding and urban renewal authority to foster the development and redevelopment to protect the public health, safety, and welfare of the City of Wilsonville; and

WHEREAS, the Original Plan has been subsequently amended by the City Council nine times (as amended, the "Plan"); and

WHEREAS, on November 7, 2014, the City of Wilsonville City Council adopted the October 27, 2014 Urban Renewal Strategic Plan (the “Strategic Plan”); and

WHEREAS, the Strategic Plan recommends moving the “Old Town Escape” project from the West Side Urban Renewal Plan to the Plan to enable completion of the project and reallocating funding from “livability projects” to Town Center planning; and

WHEREAS, the Wilsonville Urban Renewal Agency (“Agency”), the duly organized and acting urban renewal agency of the City of Wilsonville has prepared an amendment to the Plan (the "Tenth Amendment") to add property to complete the “Old Town Escape” project, add the “Old Town Escape” project and delete property for the purposes of putting property back on the general tax rolls, which is attached to this resolution as Exhibit A and incorporated herein by this reference; and

WHEREAS, the area to be added to and removed from the Year 2000 Urban Renewal Plan is identified in the Report on the Year 2000 Plan, attached hereto as Exhibit B and incorporated herein by reference.

WHEREAS, the Tenth Amendment is being adopted as a Council Approved Amendment pursuant to Section 1200 of the Plan. Section 1200 requires City Council approval if the Agency undertakes a Minor Amendment that alters the Goals and Objectives of The Plan. While there is a goal that addresses transportation projects, the Agency desired to have Council approval on the amendment as it was directed under implementation of the City Council approved Strategic Plan.

The Agency has complied with all of the requirements for adoption of the Amendment under the Plan.

NOW, THEREFORE, THE URBAN RENEWAL AGENCY OF THE CITY OF WILSONVILLE RESOLVES AS FOLLOWS:

1. Based on the above recitals, the City of Wilsonville Urban Renewal Agency does hereby adopt the Tenth Amendment to the Year 2000 Urban Renewal Plan attached hereto as Exhibit A, and incorporated herein by this reference.

2. Agency does hereby direct that the Tenth Amendment to the Year 2000 Urban Renewal Plan be forwarded to the Wilsonville City Council for adoption.

3. This Resolution is effective upon adoption.

ADOPTED by the Wilsonville Urban Renewal Agency at a regular meeting thereof this 1st day of February, 2016 and filed with the Wilsonville City Recorder this date.

TIM KNAPP, Chair

ATTEST:

Sandra C. King, MMC, City Recorder

SUMMARY OF VOTES:

Chair Knapp - Abstain

Member Starr - Excused

Member Fitzgerald - Yes

Member Stevens - Yes

Member Lehan - Yes

ATTACHMENTS:

Exhibit A – Plan Amendment

Exhibit B – Report on the Year 2000 Plan

Exhibit A: Tenth Amendment to the Year 2000 Urban Renewal Plan

Year 2000 Urban Renewal Plan - Council Approved Amendment – Tenth Amendment

The following changes are made to the Year 2000 Urban Renewal Plan. Deletions are shown in ~~crossout~~ and additions are shown in *italics*.

See map sheet 11 at page 25 of file

Section 100 - Introduction

The Year 2000 Plan ~~is a~~ *was originally* a 856.92 acre, Urban Renewal Plan of the City of Wilsonville, Oregon. *It was adopted by Ordinance No. 273 in 1990.*

The Urban Renewal Area is located entirely within the incorporated City of Wilsonville, Clackamas County, Oregon. The Urban Renewal Area consists of a single geographic area with an estimated total taxable 1989-90 true cash value of \$30,327,560. *The 2015/16 assessed value as designated by the Clackamas County Assessor is \$425,179,742.*

There have been numerous amendments to the urban renewal plan, all incorporated into the Plan. Minor amendments approved under URA Resolutions 32 and 59 added 11.22 acres to the Plan Area. URA Resolutions 99,102,118, 176 and 2440 removed acreage and added a small amount of acreage resulting in an overall acreage of 570 acres. The 2015 Amendment will further reduce acreage by 116.4 acres, deleting 120.9 acres and adding 4.5 acres for the Old Town Escape project, resulting in 454 acres in the Area.

Section 300 - Legal Description Boundary

Section 301 Exhibit A - Narrative Legal Description of Urban Renewal Area – *replaced in its entirety.*

Section 302 - Exhibit B - Graphic (Map) Description of Urban Renewal Area – *replaced in its entirety*

Section 403 - Relationship of Plan to Local Objectives

Section 404 - Consistency of City's Comprehensive Plan

Transportation:

GOAL 3.2: To encourage and support the availability of a variety of transportation choices for moving people that balance vehicular use with other transportation modes, including walking, bicycling and transit in order to avoid principal reliance upon any one mode of transportation.

Policy 3.2.1 To provide for safe and efficient vehicular, transit, pedestrian and bicycle access and circulation.

Implementation Measure 3.3.1.a. Encourage a balance among housing, employment, and commercial activities within the City so more people are able to live and work within Wilsonville, thereby reducing cross-jurisdictional commuting.

Implementation Measure 3.3.2.a. Provide pedestrian and bicycle connections between residential neighborhoods and major commercial, industrial, and recreational activity centers

throughout the city, as shown in the Bicycle and Pedestrian Master Plan. Coordinate the system of pathways planned by adjacent jurisdictions to allow for regional travel.

Implementation Measure 3.3.2.b. Concrete sidewalks will be provided on both sides of all streets unless waived when alternative provisions are found to adequately address pedestrian needs.

Implementation Measure 3.3.2.c. Transportation facilities shall be ADA-compliant.

Implementation Measure 3.3.2.d. Fill gaps in the existing sidewalk and off-street pathway systems to create a continuous network of safe and accessible bicycle and pedestrian facilities.

The Tenth Amendment is in conformance with the Transportation section of the Comprehensive Plan as the project to be added to the Plan is a transportation project to allow for a more efficient transportation system and to complete the transportation system in the Area.

Section 405 - Consistency with Economic Development Policy

The City of Wilsonville Economic Development Strategy was adopted in August of 2012. It specified ten key actions, one of which was to

Action 3.1 Coordinate capital improvement planning to ensure infrastructure availability on employment land.

The Tenth Amendment is in conformance with the Economic Development Policy as the project to be added to the Plan is a transportation project to allow for a more efficient transportation system and to complete the transportation system in the Area, allowing for increased growth on employment land and access for the residential sector to key employment land.

Section 500 - Land Use Plan

Section 501 - Land Use Designations

601 Urban Renewal Projects and Improvement Activities

14) Old Town Escape – provide an alternative route for transportation into and out of Old Town. The exact route to be determined in the future.



AKS ENGINEERING & FORESTRY, LLC
12965 SW Herman Road, Suite 100, Tualatin, OR 97062
P: (503) 563-6151 F: (503) 563-6152

AKS Job #4658

OFFICES IN: TUALATIN, OR - VANCOUVER, WA - SALEM-KEIZER, OR

EXHIBIT A

Legal Description

Year 2000 Urban Renewal Area
Wilsonville, Oregon

A tract of land located in Sections 11, 12, 13, 14, 23, and 24 of Township 3 South, Range 1 West, Willamette Meridian, City of Wilsonville, Clackamas County, Oregon, and being more particularly described as follows:

Beginning at the Section corner common to Sections 1, 2, 11, and 12 of Township 3 South, Range 1 West, Willamette Meridian, in the City of Wilsonville, Clackamas County, Oregon (Assessor's Map 3 1W 12):

1. Thence along the north section line of said Section 12, Easterly 990 feet, more or less, to the intersection of the northerly extension of the west line of Partition Plat Number 1991-159, being the True Point of Beginning (Assessor's Map 3 1W 12);
2. Thence continuing along said north section line, Easterly 1672 feet, more or less, to the north one-quarter corner of said Section 12 (Assessor's Map 3 1W 12);
3. Thence along the north-south centerline of said Section 12, Southerly 1289 feet, more or less, to the northerly right-of-way line of Wiedemann Road (Assessor's Map 3 1W 12);
4. Thence along said northerly right-of-way line and the westerly extension thereof, Westerly 821 feet, more or less, to the northerly extension of the easterly right-of-way line of Canyon Creek Road North (Assessor's Map 3 1W 12);
5. Thence along said easterly right-of-way line and the northerly extension thereof, Southerly 1128 feet, more or less, to the westerly northwest corner of Lot 1 of the plat of "Canyon Creek Estates," also being on the southerly right-of-way line of Roanoke Drive South (Assessor's Map 3 1W 12BD);
6. Thence along said southerly right-of-way line, Easterly 506 feet, more or less, to the southerly extension of the easterly right-of-way line of McLeod Street (Assessor's Map 3 1W 12BD);
7. Thence along said easterly right-of-way line and the southerly extension thereof, Northerly 465 feet, more or less, to the southerly right-of-way line of Roanoke Drive North (Assessor's Map 3 1W 12BD);
8. Thence along said southerly right-of-way line, Southeasterly 159 feet, more or less, to the most northerly corner of Lot 72 of said plat (Assessor's Map 3 1W 12BD);
9. Thence Northeasterly 39 feet, more or less, to the intersection of the northerly right-of-way line of Roanoke Drive North and the most southerly corner of Tract 'M' of said plat (Assessor's Map 3 1W 12BD);
10. Thence along the southerly line of said Tract 'M', Northeasterly 122 feet, more or less, to the most northerly corner of Lot 28 of said plat (Assessor's Map 3 1W 12BD);

11. Thence along the easterly line of said Lot 28 and the easterly lines of Lots 27, 26, and 25 of said plat, Southerly 210 feet, more or less, to the southeasterly corner of said Lot 25 (Assessor's Map 3 1W 12BD);
12. Thence along the southwesterly line of said Lot 25, Southwesterly 90 feet, more or less, to the easterly right-of-way line of Roanoke Drive North (Assessor's Map 3 1W 12BD);
13. Thence along said easterly right-of-way line, Southeasterly 15 feet, more or less, to the northwesterly corner of Lot 24 of said plat (Assessor's Map 3 1W 12BD);
14. Thence along the northwesterly line of said Lot 24, Northeasterly 90 feet, more or less, to the northeasterly corner of said Lot 24 (Assessor's Map 3 1W 12BD);
15. Thence along the northeasterly line of said Lot 24 and the northeasterly lines of Lots 23, 22, and 21, Southeasterly 225 feet, more or less, to the north-south centerline of said Section 12 (Assessor's Map 3 1W 12BD);
16. Thence along said north-south centerline, Southerly 1008 feet, more or less, to the easterly southeast corner of Tract 'R' of the plat of "Canyon Creek Meadows" (Assessor's Map 3 1W 12CA);
17. Thence along the southeasterly line of said Tract 'R', Southwesterly 196 feet, more or less, to the south line of said plat (Assessor's Map 3 1W 12CA);
18. Thence along said south line, Westerly 771 feet, more or less, to the easterly right-of-way line of Canyon Creek Road North (Assessor's Map 3 1W 12CA);
19. Thence along said easterly right-of-way line, Southerly 1691 feet, more or less, to the northerly right-of-way line of Boeckman Road (Assessor's Map 3 1W 12D);
20. Thence along said northerly right-of-way line and the easterly extension thereof, Easterly 3576 feet, more or less, to the east line of said Section 12 (Assessor's Map 3 1W 12D);
21. Thence along said east line, Southerly 30 feet, more or less, to the section corner common to Sections 12 and 13, Township 3 South, Range 1 West, and Sections 7 and 18, Township 3 South, Range 1 East (Assessor's Map 3 1W 13);
22. Thence along the east line of Section 13, Township 3 South, Range 1 West, Southerly 1317 feet, more or less, to the North 1/16th corner common to said Sections 13 and 18 (Assessor's Map 3 1W 13AA);
23. Thence along the south line of the Northeast One-Quarter of the Northeast One-Quarter of said Section 13, Westerly 479 feet, more or less, to the west line of Lot 44 of the plat of "Landover" (Assessor's Map 3 1W 13AA);
24. Thence along said west line, Northerly 86 feet, more or less, to the southerly right-of-way line of SW Wagner Street (Assessor's Map 3 1W 13AA);
25. Thence along said southerly right-of-way line, Southwesterly 26 feet, more or less, to the easterly right-of-way line of Wilsonville Road (Assessor's Map 3 1W 13AA);
26. Thence along said easterly right-of-way line and the southerly right-of-way lines of Wilsonville Road, Southwesterly 5871 feet, more or less, to the easterly right-of-way line of Kolbe Lane (Assessor's Map 3 1W 24);
27. Thence along said easterly right-of-way line, Southerly 141 feet, more or less, to the most northerly corner of Document Number 92-076392 (Assessor's Map 3 1W 24);
28. Thence along the easterly lines of said Deed, Southerly 286 feet, more or less, to the northerly right-of-way line of said Kolbe Lane (Assessor's Map 3 1W 24);

29. Thence along said northerly right-of-way line, Easterly 407 feet, more or less, to the point of tangency of said right-of-way line (Assessor's Map 3 1W 24);
30. Thence Southerly 56 feet, more or less, to the southwesterly corner of Document Number 2001-030989, being on the southerly right-of-way line of said Kolbe Lane (Assessor's Map 3 1W 24A);
31. Thence along said southerly right-of-way line, Westerly 1089 feet, more or less, to the southerly right-of-way line of Wilsonville Road (Assessor's Map 3 1W 24);
32. Thence along said southerly right-of-way line, Westerly 580 feet, more or less, to the easterly right-of-way line of Memorial Drive (Assessor's Map 3 1W 24);
33. Thence along the easterly and southerly right-of-way lines of Memorial Drive, Southwesterly 3337 feet, more or less, to the northwesterly corner of Parcel 1 of Partition Plat Number 1999-017 (Assessor's Map 3 1W 24CB);
34. Thence Westerly 592 feet, more or less, to the intersection of the east line of the Thomas Bailey Donation Land Claim No. 45 and the southerly right-of-way line of 5th Street (Assessor's Map 3 1W 23AC);
35. Thence along said east Donation Land Claim line, Southerly 616 feet, more or less, to the southeast corner of Document Number 96-084506 (Assessor's Map 3 1W 23AC);
36. Thence along the south line of said Deed and the north line of Document Number 71-32182 and Document Number 93-64436, Westerly 592 feet, more or less, to the easterly right-of-way line of Magnolia Avenue (Assessor's Map 3 1W 23DB);
37. Thence along said easterly right-of-way line, Southerly 271 feet, more or less, to the northerly line of Document Number 2005-093982 (Assessor's Map 3 1W 23DB);
38. Thence along said northerly line, Easterly 110 feet, more or less, to the northeast corner of said Deed (Assessor's Map 3 1W 23DB);
39. Thence along the east line of said Deed, Southerly 333 feet, more or less, to the northerly right-of-way line of Tauchman Street (Assessor's Map 3 1W 23DB);
40. Thence along said northerly right-of-way line, Southeasterly 245 feet, more or less, to the west line of Document Number 71-32182 (Assessor's Map 3 1W 23DB);
41. Thence along said west line, Southerly 33 feet, more or less, to the southerly right-of-way line of said Tauchman Street (Assessor's Map 3 1W 23DB);
42. Thence along said southerly right-of-way line, Northwesterly 665 feet, more or less, to the easterly right-of-way line of Boones Ferry Road (Main Street, Market Road No. 27) (Assessor's Map 3 1W 23DB);
43. Thence along said easterly right-of-way line, Southeasterly 643 feet, more or less, to the ordinary high waterline of the Willamette River (Assessor's Map 3 1W 23DB);
44. Thence along said ordinary high waterline, Westerly 63 feet, more or less, to the westerly right-of-way line of said Boones Ferry Road (Assessor's Map 3 1W 23DB);
45. Thence along said westerly right-of-way line, Northwesterly 848 feet, more or less, to the southerly right-of-way line of 2nd Street (Assessor's Map 3 1W 23CA);
46. Thence along said southerly right-of-way line, Westerly 177 feet, more or less, to the northwest corner of Lot 2, Block J of the plat of "Wilsonville" (Assessor's Map 3 1W 23CA);
47. Thence Northerly 48 feet, more or less, to the intersection of northerly right-of-way line of said 2nd Street and the southerly extension of the west line of Lot 2, Block H of the plat of "Wilsonville" (Assessor's Map 3 1W 23BD);

48. Thence along said northerly right-of-way line, Easterly 181 feet, more or less, to the westerly right-of-way line of Boones Ferry Road (Assessor's Map 3 1W 23BD);
49. Thence along said westerly right-of-way line, Northerly 938 feet, more or less, to the southerly right-of-way line of 5th Street (Assessor's Map 3 1W 23BD);
50. Thence along said southerly right-of-way line and the westerly extension thereof, Westerly 944 feet, more or less, to the east line of Document Number 90-020013 (Assessor's Map 3 1W 23BD);
51. Thence continuing along the westerly extension of said southerly right-of-way line, North 88°52'40" West 74.60 feet, more or less, to an angle point (Assessor's Map 3 1W 23BD);
52. Thence North 58°17'48" West 172.13 feet, more or less, to an angle point (Assessor's Map 3 1W 23BD);
53. Thence North 19°42'47" West 188.26 feet, more or less, to the north line of said Deed (Assessor's Map 3 1W 23BD);
54. Thence North 19°42'47" West 76.13 feet, more or less, to an angle point (Assessor's Map 3 1W 23B);
55. Thence North 17°23'14" West 335.50 feet, more or less, to a point of curvature (Assessor's Map 3 1W 23B);
56. Thence along a non-tangential curve to the left, with a Radius of 190.00 feet, Length of 193 feet, and a Chord of South 46°30'31" East 193.14 feet, more or less, to a point of tangency (Assessor's Map 3 1W 23B);
57. Thence South 17°23'14" East 172.12 feet, more or less, to an angle point (Assessor's Map 3 1W 23B);
58. Thence South 19°42'47" East 109.45 feet, more or less, to the north line of Document Number 90-020013 (Assessor's Map 3 1W 23BD);
59. Thence South 19°42'47" East 121.61 feet, more or less, to an angle point (Assessor's Map 3 1W 23BD);
60. Thence South 58°17'48" East 174.80 feet, more or less, to the intersection of the east line of Document Number 90-020013 and the northerly right-of-way line of 5th Street (Assessor's Map 3 1W 23BD);
61. Thence along said northerly right-of-way line, Easterly 956 feet, more or less, to the westerly right-of-way line of Boones Ferry Road (Assessor's Map 3 1W 23BD);
62. Thence along said westerly right-of-way line, Northerly 897 feet, more or less, to the southerly right-of-way line of Bailey Street (Assessor's Map 3 1W 23AB);
63. Thence along said southerly right-of-way line, Easterly 98 feet, more or less, to the easterly right-of-way line to said Boones Ferry Road (Assessor's Map 3 1W 23AB);
64. Thence southerly along said easterly right-of-way line, Southerly 295 feet, more or less, to the north line of the plat of "Wilsonville" (Assessor's Map 3 1W 23AC);
65. Thence along said north line and the easterly extension thereof, Easterly 743 feet, more or less, to the west line of a 25.00-foot wide Public Road per Document Number 2003-04532, being a line parallel with and 25.00 feet westerly of the east line of the Thomas Bailey Donation Land Claim No. 45 (Assessor's Map 3 1W 23AC);
66. Thence along the west line of said Public Road, Southerly 435 feet, more or less, to the northerly right-of-way line of 5th Street (Assessor's Map 3 1W 23AC);
67. Thence Southeasterly 43 feet, more or less, to the southwest corner of Parcel 2 of Partition Plat Number 2000-83 (Assessor's Map 3 1W 23AC);

68. Thence along the south line of said plat and the easterly extension thereof, Easterly 528 feet, more or less, to the easterly right-of-way line of Interstate 5 (Assessor's Map 3 1W 23A);
69. Thence along said easterly right-of-way line, Northerly 1312 feet, more or less, to the northwest corner of Document Number 96-027391 (Assessor's Map 3 1W 23AA);
70. Thence along the westerly extension of the northerly line of Document Number 96-027391, Westerly 339 feet, more or less, to the westerly right-of-way line of said Interstate 5 (Assessor's Map 3 1W 23AB);
71. Thence along said westerly right-of-way line, Northerly 529 feet, more or less, to the southerly right-of-way line of Wilsonville Road (Assessor's Map 3 1W 23AB);
72. Thence westerly along said southerly right-of-way line, Westerly 569 feet, more or less, to the easterly right-of-way line of Boones Ferry Road (Assessor's Map 3 1W 23AB);
73. Thence along said easterly right-of-way line, Southerly 1073 feet, more or less, to the northerly right-of-way line of Bailey Street (Assessor's Map 3 1W 23AB);
74. Thence along said northerly right-of-way line, Westerly 424 feet, more or less, to the east line of the Oregon Electric Railroad right-of-way (Assessor's Map 3 1W 23AB);
75. Thence Southwesterly 67 feet, more or less, to the southeast corner of Parcel 2 of Partition Plat Number 1990-092 (Assessor's Map 3 1W 23B);
76. Thence along the south line of said Parcel 2 and the westerly extension thereof, Westerly 985 feet, more or less, to a point of curvature (Assessor's Map 3 1W 23B);
77. Thence along a curve to the right with a Radius of 130 feet and a Length of 228 feet, more or less, to a point of tangency with a line parallel with and 30.00 feet easterly of the east line of the Industrial Way right-of-way (Assessor's Map 3 1W 23B);
78. Thence along said parallel line, Northeasterly 588 feet, more or less, to the north line of the Thomas Bailey Donation Land Claim No. 45 (Assessor's Map 3 1W 23B);
79. Thence along said north Donation Land Claim line, Easterly 75 feet, more or less, to the westerly right-of-way line of Kinsman Road (Assessor's Map 3 1W 23B);
80. Thence along said westerly right-of-way line, Northeasterly 465 feet, more or less, to the southerly right-of-way line of Wilsonville Road (Assessor's Map 3 1W 23B);
81. Thence Northerly 99 feet, more or less, to the intersection of the northerly right-of-way line of said Wilsonville Road and the westerly right-of-way line of said Kinsman Road (Assessor's Map 3 1W 14C);
82. Thence along said northerly right-of-way line, Easterly 1043 feet, more or less, to the southwest corner of Document Number 2011-056296 (Assessor's Map 3 1W 14D);
83. Thence along the west line of said Deed, Northerly 131 feet, more or less, to the northwest corner of said Deed (Assessor's Map 3 1W 14D);
84. Thence along the northerly and easterly lines of said Deed, Easterly 200 feet, more or less, to the northwest corner of Document Number 2014-044714 (Assessor's Map 3 1W 14D);
85. Thence along the northerly and easterly lines of said Deed, Southeasterly 156 feet, more or less, to the northerly right-of-way line of said Wilsonville Road (Assessor's Map 3 1W 14D);
86. Thence along said northerly right-of-way line, Easterly 193 feet, more or less, to the westerly right-of-way line of Boones Ferry Road (Assessor's Map 3 1W 14D);

87. Thence along said westerly right-of-way line, Northeasterly 291 feet, more or less, to the easterly southeast corner of Parcel 2 of Partition Plat Number 2003-082 (Assessor's Map 3 1W 14D);
88. Thence along a line perpendicular to the said westerly right-of-way line, Southeasterly 82 feet, more or less, to the easterly right-of-way line of said Boones Ferry Road (Assessor's Map 3 1W 14D);
89. Thence along said easterly right-of-way line, Southerly 259 feet, more or less, to the northerly right-of-way line of Wilsonville Road (Assessor's Map 3 1W 14D);
90. Thence along said northerly right-of-way line, Easterly 125 feet, more or less, to the southeasterly corner of Document Number 96-020104 (Assessor's Map 3 1W 14D);
91. Thence along the southeasterly line of said Deed Northeasterly 274 feet, more or less, to the southwesterly corner of Parcel 2 of Partition Plat Number 2007-121 (Assessor's Map 3 1W 14D);
92. Thence along the southerly line of said Parcel 2, Easterly 28 feet, more or less, to the westerly right-of-way line of Interstate 5 (Assessor's Map 3 1W 14D);
93. Thence Easterly 631 feet, more or less, to the easterly right-of-way line of said Interstate 5 and the southerly corner of Document Number 2013-033879, also being the northerly right-of-way line of Wilsonville Road (Assessor's Map 3 1W 14D);
94. Thence along said northerly right-of-way line, Easterly 543 feet, more or less, to the westerly right-of-way line of Town Center Loop Road West (Assessor's Map 3 1W 14D);
95. Thence along said westerly right-of-way line, Northwesterly 1227 feet, more or less, to the south line of Parcel 3 of Partition Plat Number 1991-202 (Assessor's Map 3 1W 14D);
96. Thence along said south line, Westerly 82 feet, more or less, to the easterly right-of-way line of said Interstate 5 (Assessor's Map 3 1W 14D);
97. Thence along said easterly right-of-way line, Northerly 1672 feet, more or less, to the south line of Partition Plat Number 2011-058 (Assessor's Map 3 1W 14A);
98. Thence along said south line, Easterly 1082 feet, more or less, to the westerly right-of-way line of Parkway Avenue (Assessor's Map 3 1W 14A);
99. Thence along said westerly right-of-way line, Northerly 3106 feet, more or less, to the southeast corner of Document Number 95-063608 (Assessor's Map 3 1W 11);
100. Thence Easterly 72 feet, more or less, to the most westerly northwest corner of Parcel 1 of Partition Plat Number 2005-022, being on the easterly right-of-way line of Parkway Avenue (Assessor's Map 3 1W 12);
101. Thence along said easterly right-of-way line, Southerly 414 feet, more or less, to the northerly right-of-way line of Boeckman Road (Assessor's Map 3 1W 12);
102. Thence along said northerly right-of-way line Easterly 2015 feet, more or less, to the westerly right-of-way line of Canyon Creek Road (Assessor's Map 3 1W 12);
103. Thence along said westerly right-of-way line, Northerly 2570 feet, more or less, to the intersection of the east-west centerline of Section 12 (Assessor's Map 3 1W 12);
104. Thence leaving said right-of-way line, along a line parallel with the west line of Parcel 4 of Document Number 2000-000158, North 01°30'22" East 1278 feet, more or less, to the southerly right-of-way line of Wiedemann Road (Assessor's Map 3 1W 12);

105. Thence along said southerly right-of-way line, Westerly 2810 feet, more or less, to the easterly right-of-way line of Parkway Avenue (Assessor's Map 3 1W 11);
106. Thence along said easterly right-of-way line, Southerly 1371 feet, more or less, to the northerly line of Partition Plat Number 2002-047 (Assessor's Map 3 1W 11D);
107. Thence along the northerly lines of Parcel 3 and Parcel 5 of said plat, Southeasterly 1965 feet, more or less, to the most easterly corner of said Parcel 5 (Assessor's Map 3 1W 11D);
108. Thence along the southeasterly line of said Parcel 5, Southwesterly 433 feet, more or less, to the northeasterly corner of Parcel 2 of Partition Plat Number 2005-022 (Assessor's Map 3 1W 12);
109. Thence along the easterly and southerly lines of said Parcel 2, Southwesterly 1243 feet, more or less, to the southeast corner of Document Number 2010-076176 (Assessor's Map 3 1W 12);
110. Thence along the easterly line of said Deed, Northerly 378 feet, more or less, to the westerly south line of Parcel 2 of Partition Plat Number 2005-022 (Assessor's Map 3 1W 12);
111. Thence along said south line and the westerly extension thereof, Westerly 455 feet, more or less, to the westerly right-of-way line of Parkway Avenue (Assessor's Map 3 1W 11D);
112. Thence along said westerly right-of-way line, Northerly 3026 feet, more or less, to the westerly extension of the northerly right-of-way line of Wiedemann Road (Assessor's Map 3 1W 11);
113. Thence along said northerly right-of-way line and the westerly extension thereof, Easterly 2156 feet, more or less, to the southwest corner of Parcel 1 of Partition Plat Number 1993-133 (Assessor's Map 3 1W 12);
114. Thence along the west line of said Parcel 1 and the west line of Parcel 1 of Partition Plat Number 1991-159 and the northerly extension thereof, Northerly 1287 feet, more or less, to the True Point of Beginning.

Excepting the following parcels:

Parcel 1:

Beginning at the northwest corner of Lot 21 of the plat of "Sundial" (Assessor's Map 3 1W 13BD):

115. Thence along the north line of said plat, Easterly 656 feet, more or less, to the easterly right-of-way line of Canyon Creek Road South (Assessor's Map 3 1W 13BD);
116. Thence along said easterly right-of-way line, Northerly 1970 feet, more or less, to the southerly right-of-way line of Boeckman Road (Assessor's Map 3 1W 13B);
117. Thence along said southerly right-of-way line, Easterly 2932 feet, more or less, to the northwest corner of Lot 86 of the plat of "Landover No. 2" (Assessor's Map 3 1W 13AA);
118. Thence along the westerly line of said Lot 86, Southerly 28 feet, more or less, to a point on the westerly line of the vacated right-of-way line of Wilsonville Road per Document Number 96-012470 (Assessor's Map 3 1W 13AA);

119. Thence along said westerly line, Southerly 1103 feet, more or less to the south line of Lot 111 of said plat (Assessor's Map 3 1W 13AA);
120. Thence along said southerly line, Southeasterly 5 feet, more or less, to the westerly right-of-way line of Wilsonville Road (Assessor's Map 3 1W 13AA);
121. Thence along said westerly right-of-way line, Southwesterly 5567 feet, more or less, to the southeast corner of Parcel 2 of Partition Plat Number 2009-072 (Assessor's Map 3 1W 13CD);
122. Thence along the easterly line of said Parcel 2, Northerly 426 feet, more or less, to the northeast corner of said Parcel 2 (Assessor's Map 3 1W 13CD);
123. Thence along the northerly line of said Parcel 2 and the northerly line of Parcel 1 of said plat, Westerly 599 feet, more or less, to the easterly right-of-way line of Town Center Loop Road East (Assessor's Map 3 1W 13CD);
124. Thence along said easterly right-of-way line, Northerly 1291 feet, more or less, to the most southerly southwest corner of Partition Plat Number 1991-166 (Assessor's Map 3 1W 13CB);
125. Thence along the southerly and easterly line of said plat, Northeasterly 318 feet, more or less, to the northwest corner of Parcel 3 of Partition Plat Number 1990-114 (Assessor's Map 3 1W 13CB);
126. Thence along the northerly line of said Parcel 3, Easterly 185 feet, more or less, to the west line of the plat of "Courtside Estates" (Assessor's Map 3 1W 13CB);
127. Thence along said west line and the northerly extension thereof, Northerly 556 feet, more less, to the northerly right-of-way line of Vlahos Drive (Assessor's Map 3 1W 13BD);
128. Thence along said northerly right-of-way line, Westerly 167 feet, more or less, to the southwest corner of Lot 21 of the plat of "Sundial" (Assessor's Map 3 1W 13BD);
129. Thence along the west line of said Lot 21, Northerly 633 feet, more or less, to the Point of Beginning.

Parcel 2:

Beginning at northeast corner of Lot 5 of the plat of "Main Street Village," also being on the southerly right-of-way line of Wilsonville Road (Assessor's Map 3 1W 24):

130. Thence along said southerly right-of-way line, Easterly 383 feet, more or less, to the westerly right-of-way line of Memorial Drive (Assessor's Map 3 1W 24);
131. Thence along said westerly right-of-way line, Southwesterly 660 feet, more or less, to the northerly line of the plat of "Village Estates Condominium Stage 2" (Assessor's Map 3 1W 23AD-2);
132. Thence along said northerly line, Northwesterly 125 feet, more or less, to the southerly extension of the east line of said Lot 5 (Assessor's Map 3 1W 23A);
133. Thence along the east line of said Lot 5 and the southerly extension thereof, Northerly 509 feet, more or less, to the Point of Beginning.

Parcel 3:

Beginning at the northerly northwest corner of Parcel 2 of Partition Plat Number 2012-057, also being on the southerly right-of-way line of Wilsonville Road (Assessor's Map 3 1W 23B):

134. Thence along said southerly right-of-way line, Easterly 1235 feet, more or less, to the westerly right-of-way line of Boones Ferry Road (Assessor's Map 3 1W 23AB);
135. Thence along said westerly right-of-way line, Southerly 1022 feet, more or less, to a line parallel with and 30.00 feet northerly of the north right-of-way line of Bailey Street (Assessor's Map 3 1W 23AB);
136. Thence along said parallel line, Westerly 326 feet, more or less, to the easterly right-of-way line of Oregon Electric Railroad (Assessor's Map 3 1W 23AB);
137. Thence Southwesterly 85 feet, more or less, to the intersection of the westerly right-of-way line of said Railroad and a line parallel with and 30.00 feet northerly of the south line of Parcel 2 of Partition Plat Number 1990-092 (Assessor's Map 3 1W 23B);
138. Thence along said parallel line and the westerly extension thereof, Westerly 914 feet, more or less, to a point of curvature (Assessor's Map 3 1W 23B);
139. Thence along a curve to the right with a Radius of 100 feet and an approximate length of 175 feet, more or less, to a line parallel with and 60.00 feet easterly of the easterly right-of-way line of Industrial Way (Assessor's Map 3 1W 23B);
140. Thence along said parallel line, Northeasterly 532 feet, more or less, to the north line of Document Number 2010-040434 (Assessor's Map 3 1W 23B);
141. Thence along said north line and the easterly extension thereof, Easterly 99 feet, more or less, to the southwesterly extension of the easterly right-of-way line of Kinsman Road (Assessor's Map 3 1W 23B);
142. Thence along said easterly right-of-way line and the southwesterly extension thereof, Northeasterly 531 feet, more or less, to the Point of Beginning.

Parcel 4:

Beginning at the southeast corner of Parcel 1 of Partition Plat Number 1990-129 (Assessor's Map 3 1W 13CB):

143. Thence along the east line of said plat, Northerly 883 feet, more or less, to the southerly right-of-way line of Town Center Loop Road East (Assessor's Map 3 1W 13CB);
144. Thence along the southerly and westerly right-of-way line of said Town Center Loop Road East, Southeasterly 1395 feet, more or less, to the south line of Document Number 2009-085920 (Assessor's Map 3 1W 13CB);
145. Thence along said south line, Westerly 867 feet, more or less, to the Point of Beginning.

Parcel 5:

Beginning at the northeast corner of Parcel 2 of Partition Plat Number 2006-013, also being on the southerly right-of-way line of Boeckman Road (Assessor's Map 3 1W 13B):

146. Thence along the east line of said Parcel 2, Southerly 577 feet, more or less, to the westerly right-of-way line of Canyon Creek Road (Assessor's Map 3 1W 13B);
147. Thence along said westerly right-of-way line, Southerly 2635 feet, more or less, to the northerly right-of-way line of Town Center Loop Road East (Assessor's Map 3 1W 13CB);

148. Thence along said northerly right-of-way line, Westerly 688 feet, more or less, to the easterly right-of-way line of Parkway Avenue (Assessor's Map 3 1W 13CB);
149. Thence along said easterly right-of-way line, Northerly 2918 feet, more or less, to the southerly right-of-way line of Boeckman Road (Assessor's Map 3 1W 13B);
150. Thence along said southerly right-of-way line, Easterly 1643 feet, more or less, to the Point of Beginning.

The above described tract of land contains 458 acres, more or less.

12/17/2015



EXHIBIT MAP YEAR 2000 URBAN RENEWAL AREA

LOCATED IN SECTIONS 11, 12, 13, 14, 23,
AND 24, TOWNSHIP 3 SOUTH, RANGE 1
WEST, WILLAMETTE MERIDIAN,
CITY OF WILSONVILLE,
CLACKAMAS COUNTY, OREGON
SHEET 1 OF 14

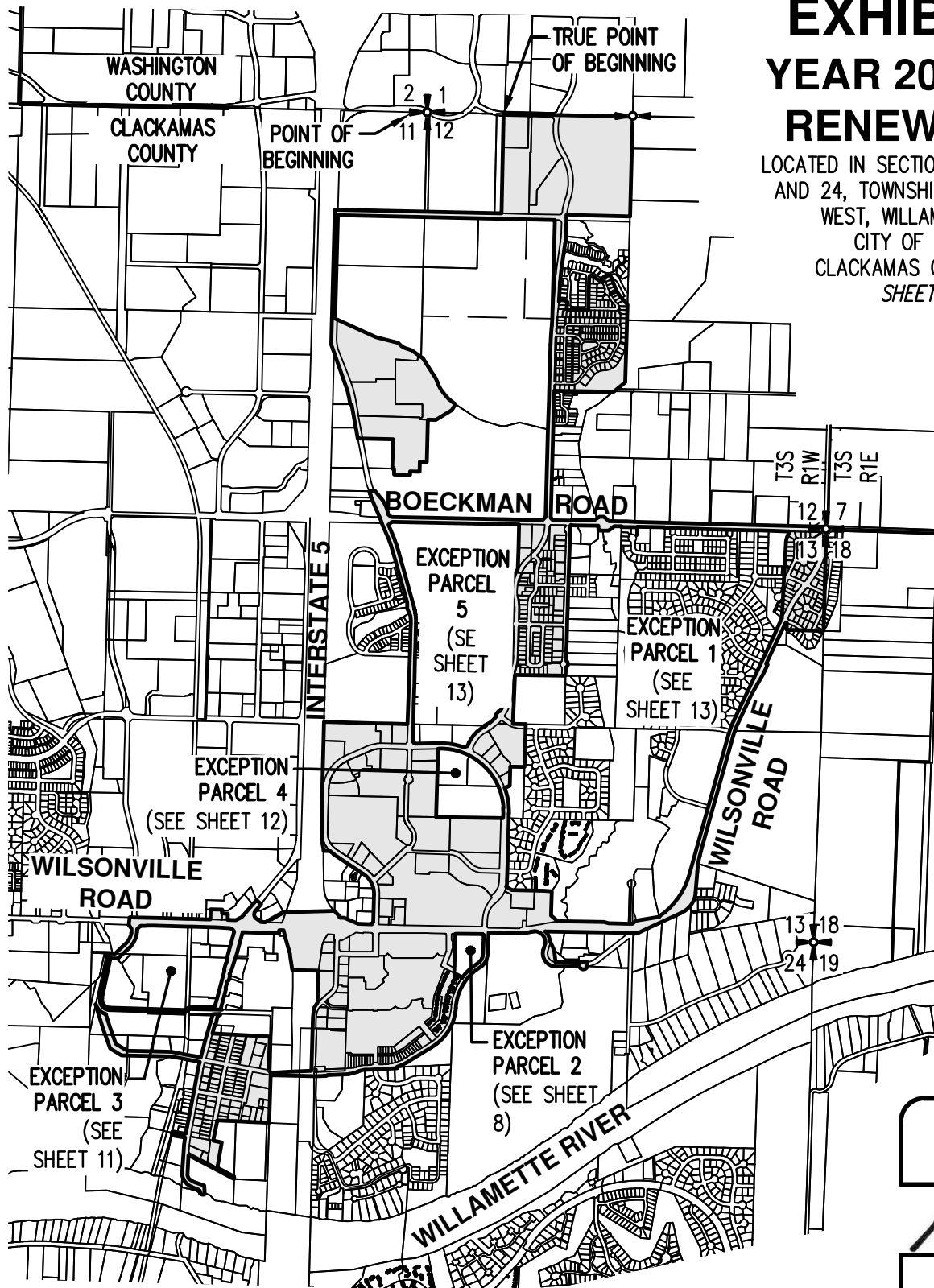

12/17/15

REGISTERED
PROFESSIONAL
LAND SURVEYOR

Nick White

OREGON
JANUARY 9, 2007
NICK WHITE
70652LS
RENEWS: 6/30/16

LEGEND

- DN. DOCUMENT NUMBER
 - PP NO. PARTITION PLAT NUMBER
 - P. PARCEL NUMBER
 -  URBAN RENEWAL AREA
- SCALE 1" = 2000 FEET

AREA = 458 ACRES±



CITY OF WILSONVILLE
URBAN RENEWAL DISTRICTS

AKS ENGINEERING & FORESTRY, LLC
12965 SW HERMAN RD, STE 100
TUALATIN, OR 97062
P: 503.563.6151 F: 503.563.6152 aks-eng.com



EXHIBIT
B

DRWN: MSK
CHKD: NSW
AKS JOB:
4658

EXHIBIT MAP

YEAR 2000 URBAN RENEWAL AREA

LOCATED IN SECTIONS 11, 12, 13, 14, 23, AND 24,
TOWNSHIP 3 SOUTH, RANGE 1 WEST, WILLAMETTE MERIDIAN,
CITY OF WILSONVILLE, CLACKAMAS COUNTY, OREGON
SHEET 2 OF 14

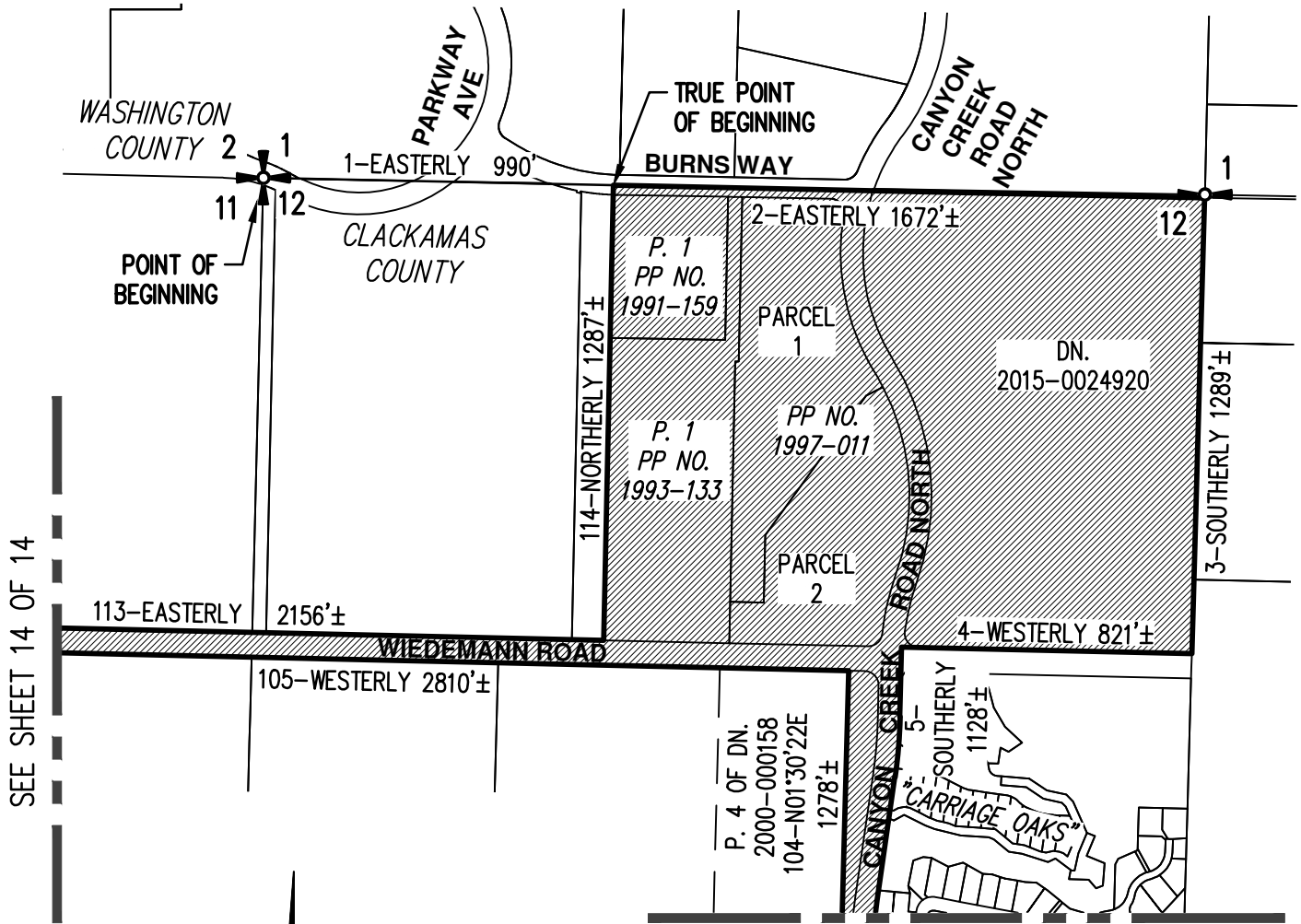

SEE SHEET 14 OF 14

SEE SHEET 3 OF 14



SCALE 1" = 500 FEET



12/17/15

REGISTERED
PROFESSIONAL
LAND SURVEYOR

OREGON
JANUARY 9, 2007
NICK WHITE
70652LS

RENEWS: 6/30/16

CITY OF WILSONVILLE URBAN RENEWAL DISTRICTS		EXHIBIT B
AKS ENGINEERING & FORESTRY, LLC 12965 SW HERMAN RD, STE 100 TUALATIN, OR 97062 P: 503.563.6151 F: 503.563.6152 aks-eng.com		DRWN: MSK CHKD: NSW AKS JOB: 4658

EXHIBIT MAP

YEAR 2000 URBAN RENEWAL AREA

LOCATED IN SECTIONS 11, 12, 13, 14, 23, AND 24, TOWNSHIP 3 SOUTH, RANGE 1 WEST, WILLAMETTE MERIDIAN, CITY OF WILSONVILLE, CLACKAMAS COUNTY, OREGON
SHEET 3 OF 14

MATCH LINE - SEE SHEET 2 OF 14

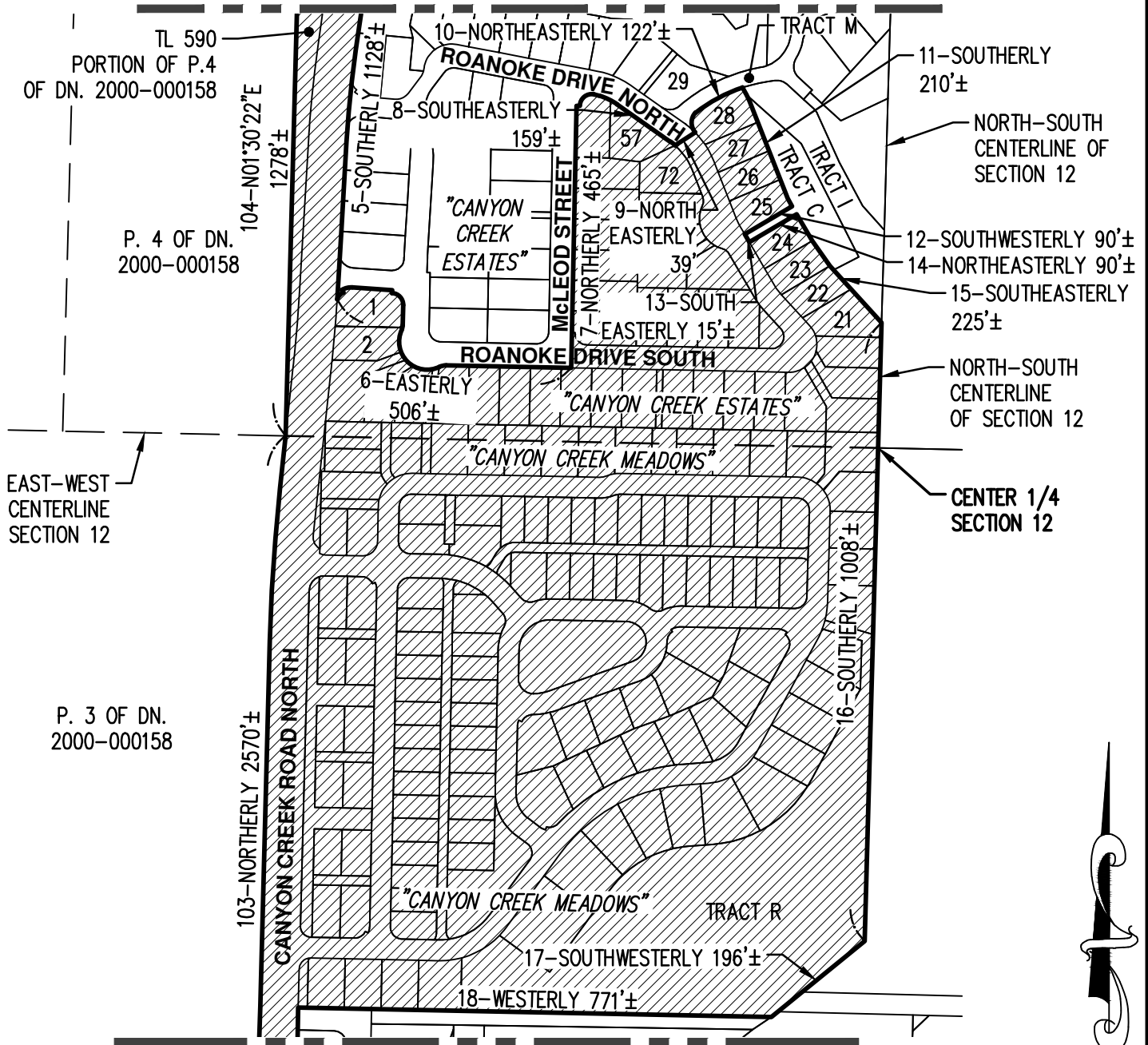

12/17/15

MATCH LINE - SEE SHEET 4 OF 14

SCALE 1" = 250 FEET



REGISTERED
PROFESSIONAL
LAND SURVEYOR

Nick White
OREGON
JANUARY 9, 2007
NICK WHITE
70652LS
RENEWS: 6/30/16

CITY OF WILSONVILLE URBAN RENEWAL DISTRICTS		EXHIBIT B
AKS ENGINEERING & FORESTRY, LLC 12965 SW HERMAN RD, STE 100 TUALATIN, OR 97062 P: 503.563.6151 F: 503.563.6152 aks-eng.com		DRWN: MSK CHKD: NSW AKS JOB: 4658

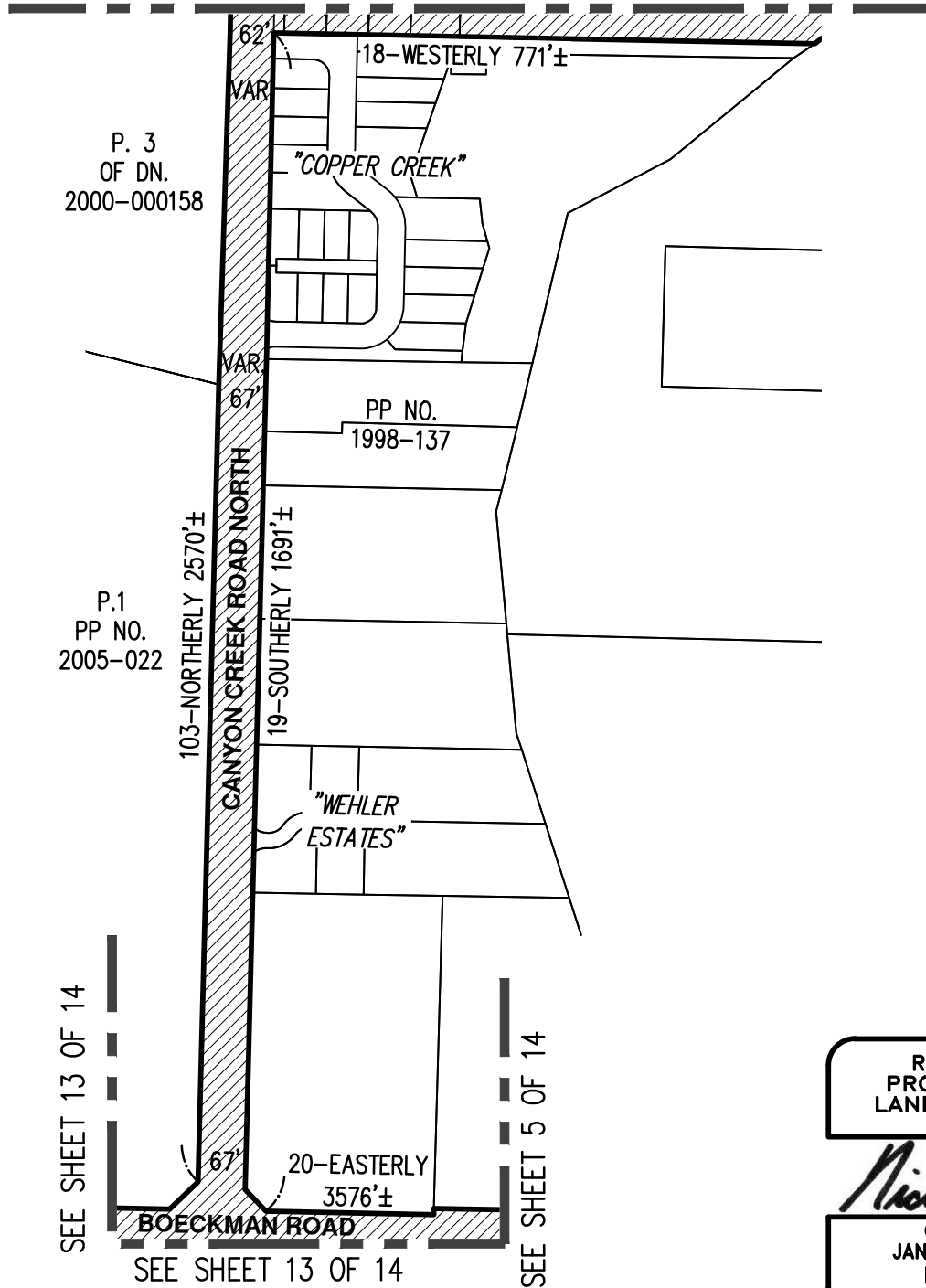

EXHIBIT MAP

YEAR 2000 URBAN RENEWAL AREA

LOCATED IN SECTIONS 11, 12, 13, 14, 23, AND 24, TOWNSHIP 3 SOUTH, RANGE 1 WEST, WILLAMETTE MERIDIAN, CITY OF WILSONVILLE, CLACKAMAS COUNTY, OREGON
SHEET 4 OF 14

SEE SHEET 3 OF 14



12/17/15

REGISTERED
PROFESSIONAL
LAND SURVEYOR

OREGON
JANUARY 9, 2007
NICK WHITE
70652LS

RENEWS: 6/30/16

SCALE 1" = 250 FEET

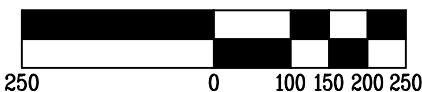

CITY OF WILSONVILLE
URBAN RENEWAL DISTRICTS

AKS ENGINEERING & FORESTRY, LLC
12965 SW HERMAN RD, STE 100
TUALATIN, OR 97062
P: 503.563.6151 F: 503.563.6152 aks-eng.com



EXHIBIT
B

DRWN: MSK
CHKD: NSW

AKS JOB:
4658

EXHIBIT MAP

YEAR 2000 URBAN RENEWAL AREA

LOCATED IN SECTIONS 11, 12, 13, 14, 23, AND 24, TOWNSHIP 3 SOUTH, RANGE 1 WEST, WILLAMETTE MERIDIAN, CITY OF WILSONVILLE, CLACKAMAS COUNTY, OREGON

SHEET 5 OF 14

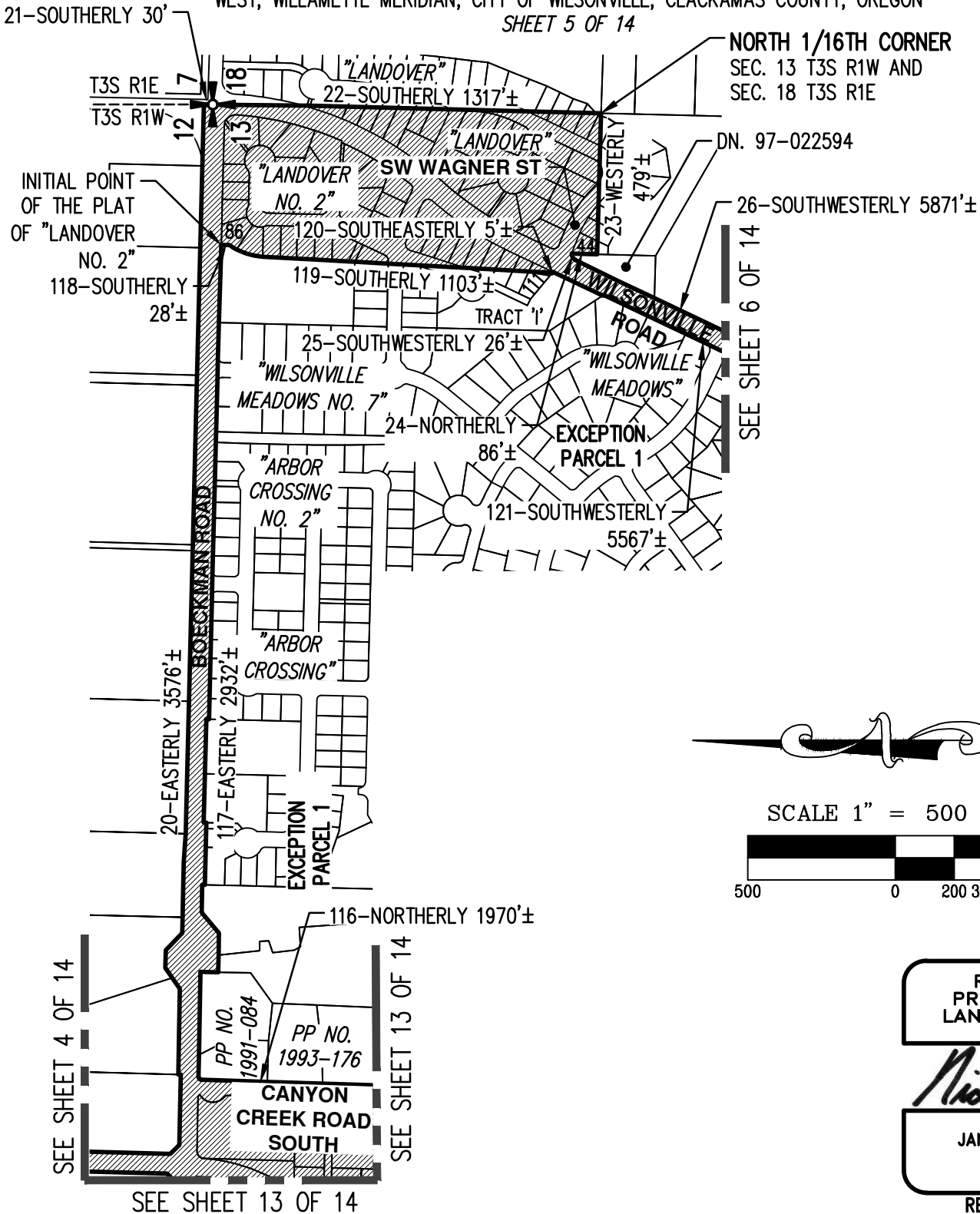

SCALE 1" = 500 FEET



12/17/15

REGISTERED
PROFESSIONAL
LAND SURVEYOR

OREGON
JANUARY 9, 2007
NICK WHITE
70652LS

RENEWS: 6/30/16

CITY OF WILSONVILLE URBAN RENEWAL DISTRICTS		EXHIBIT B
AKS ENGINEERING & FORESTRY, LLC 12965 SW HERMAN RD, STE 100 TUALATIN, OR 97062 P: 503.563.6151 F: 503.563.6152 aks-eng.com		DRWN: MSK CHKD: NSW AKS JOB: 4658



EXHIBIT MAP

YEAR 2000 URBAN RENEWAL AREA

LOCATED IN SECTIONS 11, 12, 13, 14, 23, AND 24, TOWNSHIP 3 SOUTH, RANGE 1 WEST, WILLAMETTE MERIDIAN, CITY OF WILSONVILLE, CLACKAMAS COUNTY, OREGON

SHEET 6 OF 14

12/17/15

SEE SHEET 5 OF 14

REGISTERED
PROFESSIONAL
LAND SURVEYOR

OREGON
JANUARY 9, 2007
NICK WHITE
70652LS

RENEWS: 6/30/16

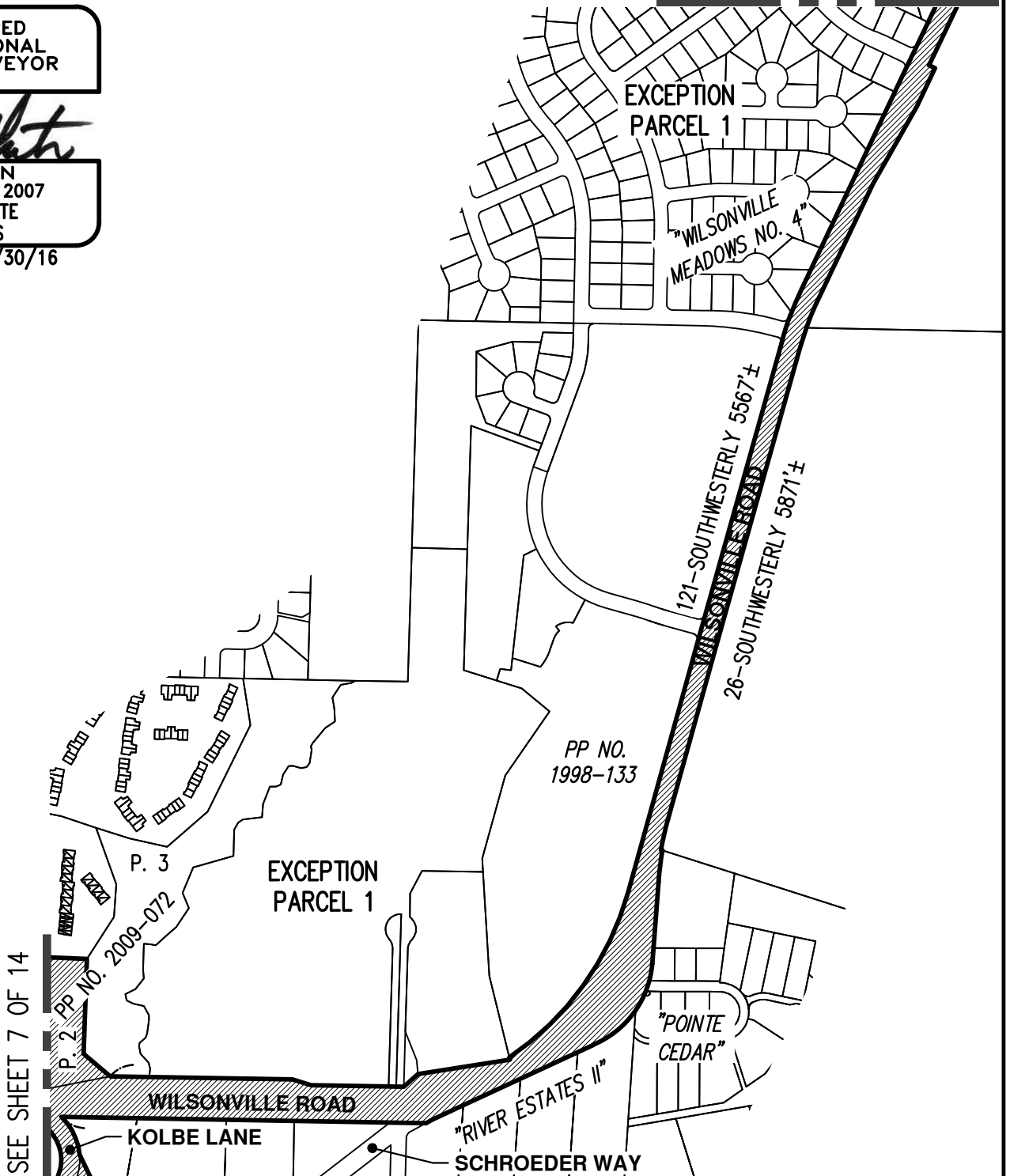

SEE SHEET 7 OF 14

SCALE 1" = 500 FEET



CITY OF WILSONVILLE
URBAN RENEWAL DISTRICTS

AKS ENGINEERING & FORESTRY, LLC
12965 SW HERMAN RD, STE 100
TUALATIN, OR 97062
P: 503.563.6151 F: 503.563.6152 aks-eng.com



EXHIBIT
B

DRWN: MSK
CHKD: NSW
AKS JOB:
4658

EXHIBIT MAP

YEAR 2000 URBAN RENEWAL AREA

LOCATED IN SECTIONS 11, 12, 13, 14, 23, AND 24, TOWNSHIP 3 SOUTH, RANGE 1 WEST, WILLAMETTE MERIDIAN, CITY OF WILSONVILLE, CLACKAMAS COUNTY, OREGON

SHEET 7 OF 14

SEE SHEET 13 OF 14

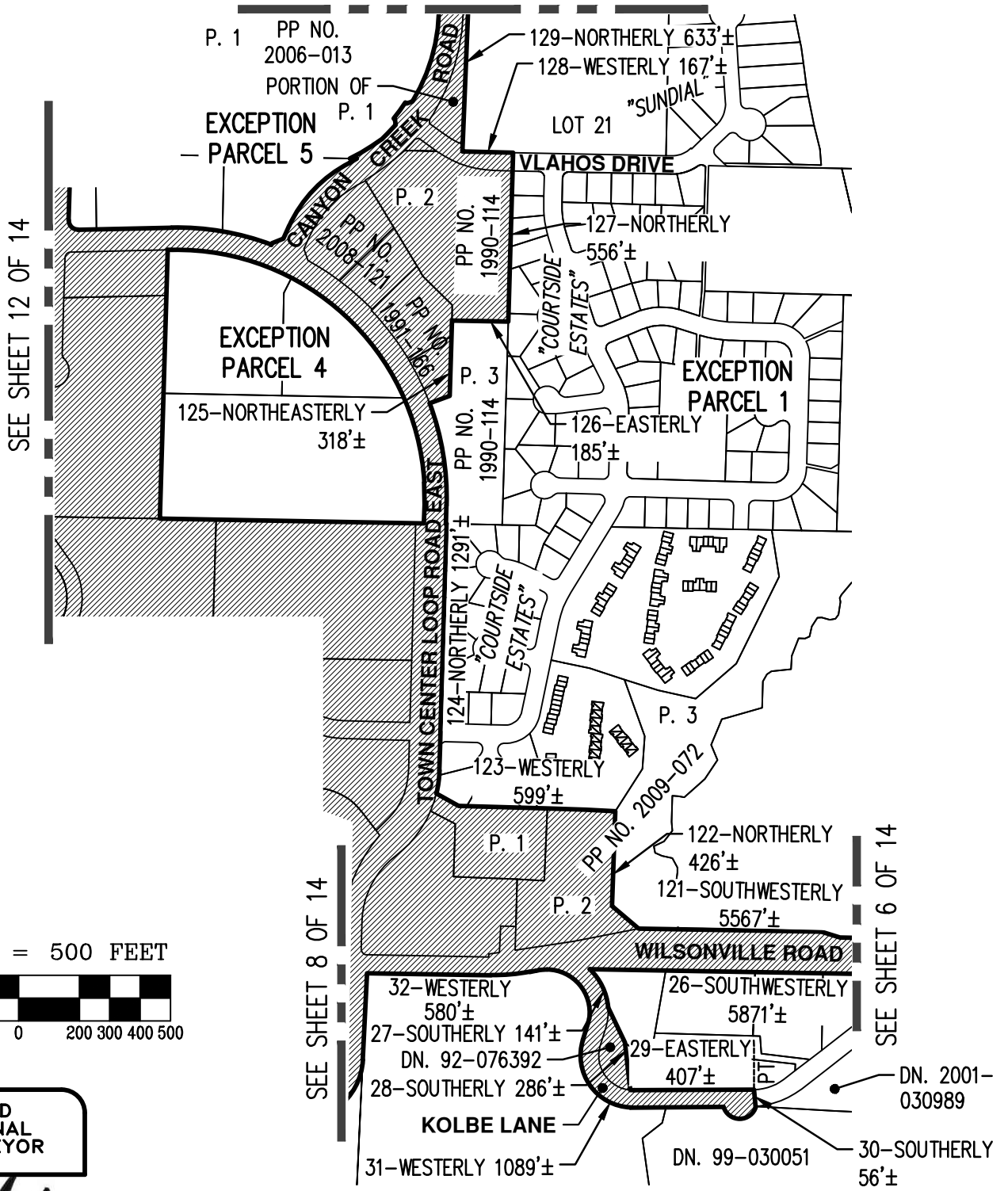

SEE SHEET 12 OF 14

SEE SHEET 8 OF 14

SEE SHEET 6 OF 14



SCALE 1" = 500 FEET



12/17/15

REGISTERED
PROFESSIONAL
LAND SURVEYOR

Nick White

OREGON
JANUARY 9, 2007
NICK WHITE
70652LS

RENEWS: 6/30/16

CITY OF WILSONVILLE
URBAN RENEWAL DISTRICTS

AKS ENGINEERING & FORESTRY, LLC
12965 SW HERMAN RD, STE 100
TUALATIN, OR 97062
P: 503.563.6151 F: 503.563.6152 aks-eng.com



EXHIBIT
B

DRWN: MSK
CHKD: NSW
AKS JOB:
4658

EXHIBIT MAP

YEAR 2000 URBAN RENEWAL AREA

LOCATED IN SECTIONS 11, 12, 13, 14, 23, AND 24, TOWNSHIP 3 SOUTH, RANGE 1 WEST, WILLAMETTE MERIDIAN, CITY OF WILSONVILLE, CLACKAMAS COUNTY, OREGON

SHEET 8 OF 14

SEE SHEET 12 OF 14

P. 3
PP NO. 1991-202

97-NORTHERLY
1672'±

DN. 2013-033879

VAR.
INTERSTATE 5

DN.
2005-012391

96-WESTERLY 82'±

TOWN CENTER
LOOP ROAD WEST
95-NORTH
WESTERLY
1227'±

POINT OF BEGINNING
EXCEPTION PARCEL 2
NE CORNER LOT 5

PLAT OF "MAIN STREET VILLAGE"

PP NO.
2008-110

SEE SHEET 10 OF 14

93-EASTERLY
631'±

94-EASTERLY
543'±

130-EASTERLY
383'±

SEE SHEET 7 OF 14

WILSONVILLE ROAD

70-WESTERLY
339'±

3
133-NORTHERLY 509'±
"MAIN STREET VILLAGE"

EXCEPTION PARCEL 2

32-WESTERLY
580'±

VAR.
165'

DN.
95-021098

4
132-NORTHWESTERLY
125'±
"MAIN STREET VILLAGE"

131-SOUTHWESTERLY
660'±

DN.
96-027391

"VILLAGE ESTATES
CONDOMINIUM STAGE 2"

SEE SHEET 9 OF 14

PP NO. 2000-83 "OLD TOWN SQUARE"

VAR.
INTERSTATE 5

69-NORTHERLY 1312'±
PARKWAY AVENUE

"MAIN STREET VILLAGE"

MEMORIAL DRIVE
33-SOUTHWESTERLY 3337'±

12/17/15

REGISTERED
PROFESSIONAL
LAND SURVEYOR

OREGON
JANUARY 9, 2007
NICK WHITE
70652LS

RENEWS: 6/30/16



SCALE 1" = 500 FEET



CITY OF WILSONVILLE
URBAN RENEWAL DISTRICTS

AKS ENGINEERING & FORESTRY, LLC
12965 SW HERMAN RD, STE 100
TUALATIN, OR 97062
P: 503.563.6151 F: 503.563.6152 aks-eng.com



EXHIBIT
B

DRWN: MSK
CHKD: NSW
AKS JOB:
4658

EXHIBIT MAP

YEAR 2000 URBAN RENEWAL AREA

LOCATED IN SECTIONS 11, 12, 13, 14, 23, AND 24, TOWNSHIP 3 SOUTH, RANGE 1 WEST, WILLAMETTE MERIDIAN, CITY OF WILSONVILLE, CLACKAMAS COUNTY, OREGON
SHEET 9 OF 14

LINE TABLE	
LINE	DIRECTION AND LENGTH
38-L1	EASTERLY 110'±
39-L2	SOUTHERLY 333'±
40-L3	SOUTHEASTERLY 245'±
41-L4	SOUTHERLY 33'±
67-L5	SOUTHEASTERLY 43'±

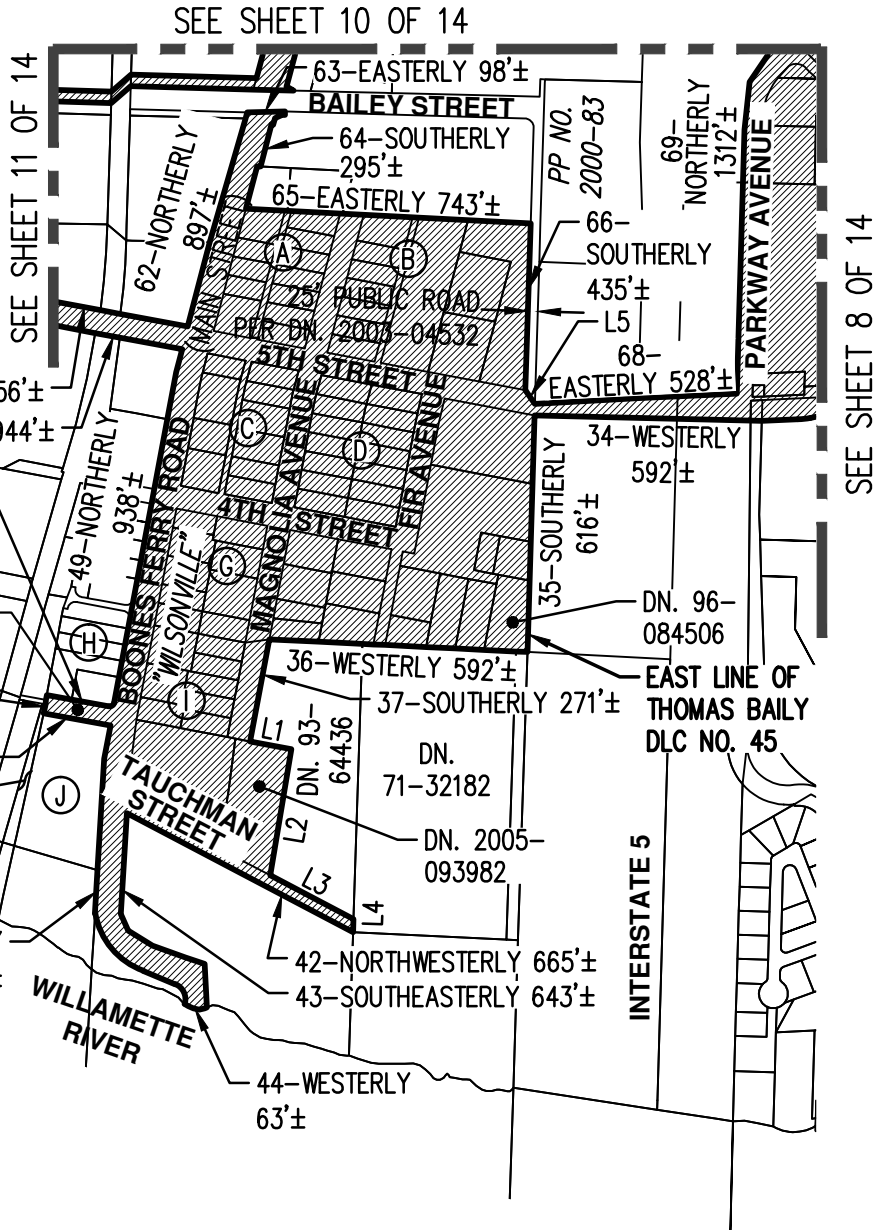

SCALE 1" = 500 FEET



12/17/15

REGISTERED
PROFESSIONAL
LAND SURVEYOR

Nick White

OREGON
JANUARY 9, 2007
NICK WHITE
70652LS
RENEWS: 6/30/16

CITY OF WILSONVILLE
URBAN RENEWAL DISTRICTS

AKS ENGINEERING & FORESTRY, LLC
12965 SW HERMAN RD, STE 100
TUALATIN, OR 97062
P: 503.563.6151 F: 503.563.6152 aks-eng.com



EXHIBIT
B

DRWN: MSK
CHKD: NSW
AKS JOB:
4658

EXHIBIT MAP

YEAR 2000 URBAN RENEWAL AREA

LOCATED IN SECTIONS 11, 12, 13, 14, 23, AND 24, TOWNSHIP 3 SOUTH, RANGE 1 WEST, WILLAMETTE MERIDIAN, CITY OF WILSONVILLE, CLACKAMAS COUNTY, OREGON
SHEET 10 OF 14

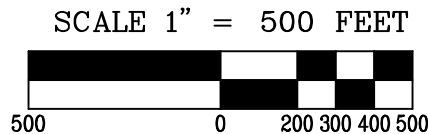
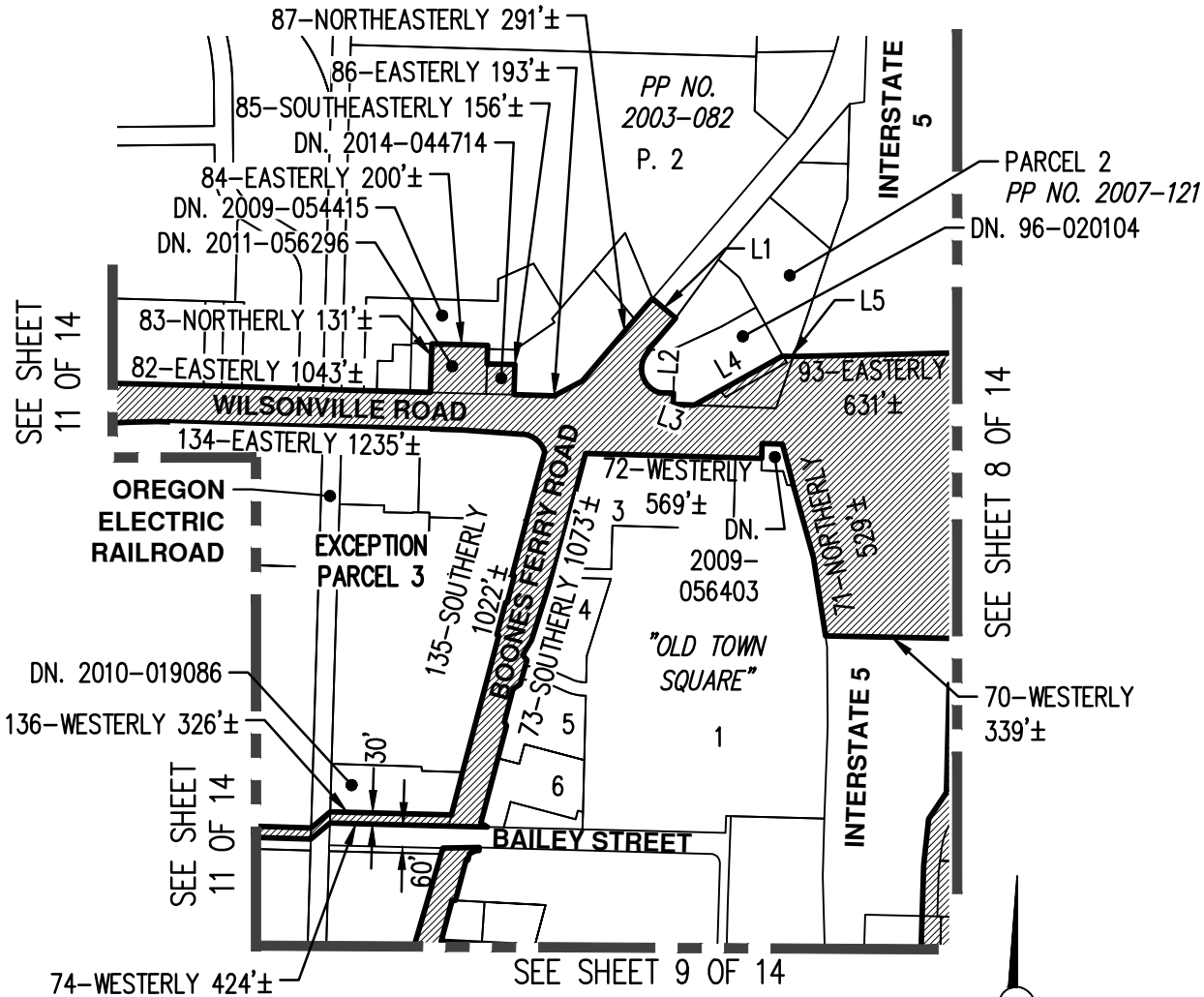

LINE TABLE	
LINE	DIRECTION AND LENGTH
88-L1	SOUTHEASTERLY 82'±
89-L2	SOUTHERLY 259'±
90-L3	EASTERLY 125'±
91-L4	NORTHEASTERLY 274'±
92-L5	EASTERLY 28'±

12/17/15

REGISTERED PROFESSIONAL LAND SURVEYOR

Nick White

OREGON
JANUARY 9, 2007
NICK WHITE
70652LS
RENEWS: 6/30/16

CITY OF WILSONVILLE URBAN RENEWAL DISTRICTS		EXHIBIT B
AKS ENGINEERING & FORESTRY, LLC 12965 SW HERMAN RD, STE 100 TUALATIN, OR 97062 P: 503.563.6151 F: 503.563.6152 aks-eng.com		DRWN: MSK CHKD: NSW AKS JOB: 4658



EXHIBIT MAP YEAR 2000 URBAN RENEWAL AREA

LOCATED IN SECTIONS 11, 12, 13, 14, 23,
AND 24, TOWNSHIP 3 SOUTH, RANGE 1
WEST, WILLAMETTE MERIDIAN, CITY OF
WILSONVILLE, CLACKAMAS COUNTY, OREGON
SHEET 11 OF 14

CURVE TABLE		
CURVE	RADIUS	LENGTH
56-C1	190.00'	193'±
77-C2	130.00'	228'±
139-C3	100.00'	175'±

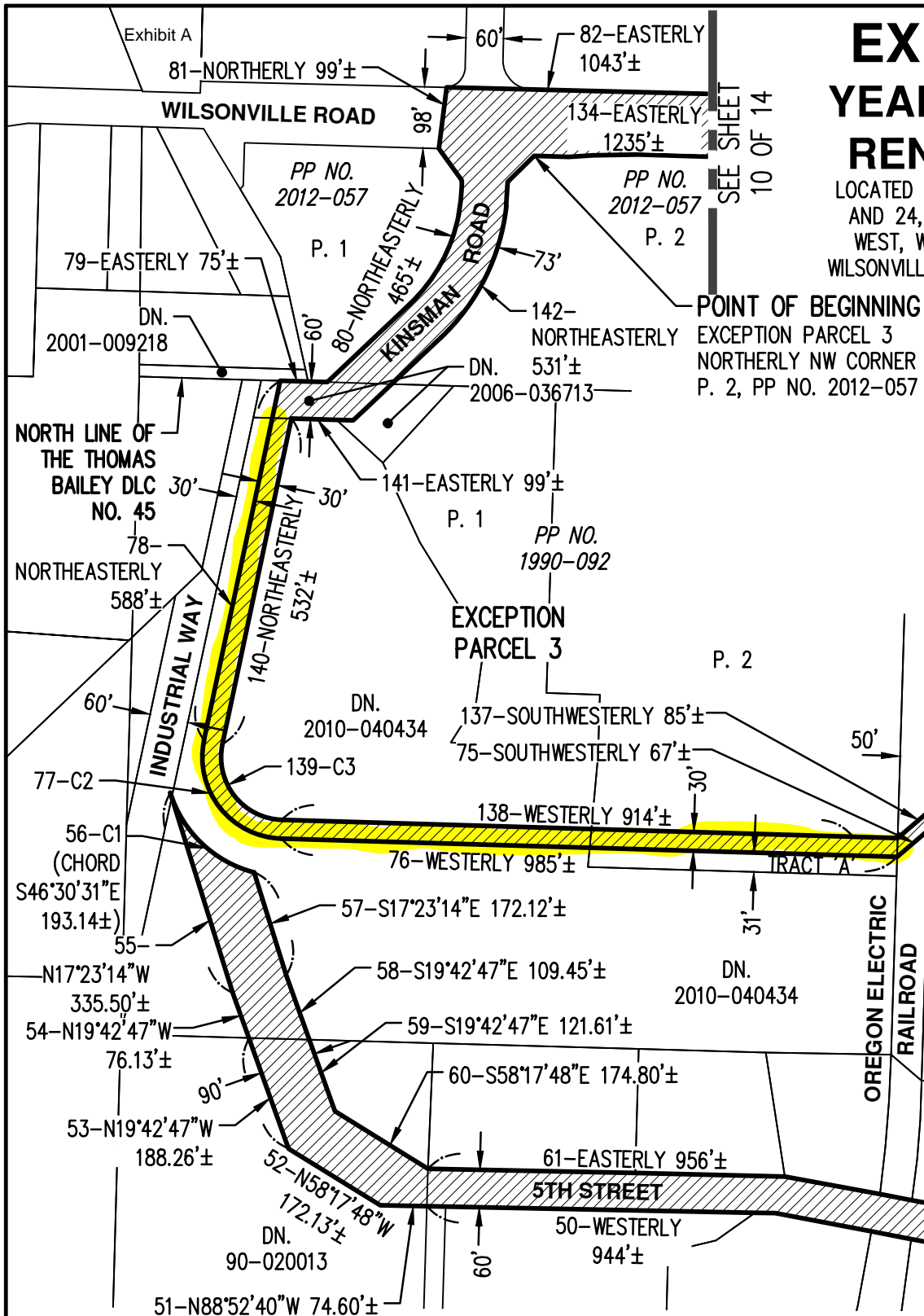

POINT OF BEGINNING
EXCEPTION PARCEL 3
NORTHERLY NW CORNER
P. 2, PP NO. 2012-057

SEE SHEET
10 OF 14

SEE SHEET
9 OF 14

12/17/15

SCALE 1" = 250 FEET

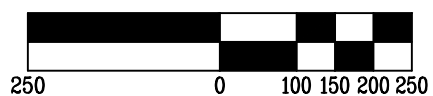

REGISTERED
PROFESSIONAL
LAND SURVEYOR

Nick White
OREGON
JANUARY 9, 2007
NICK WHITE
70652LS
RENEWS: 6/30/16

CITY OF WILSONVILLE URBAN RENEWAL DISTRICTS		EXHIBIT B
AKS ENGINEERING & FORESTRY, LLC 12965 SW HERMAN RD, STE 100 TUALATIN, OR 97062 P: 503.563.6151 F: 503.563.6152 aks-eng.com		DRWN: MSK CHKD: NSW AKS JOB: 4658



EXHIBIT MAP

YEAR 2000 URBAN RENEWAL AREA

LOCATED IN SECTIONS 11, 12, 13, 14, 23, AND 24, TOWNSHIP 3 SOUTH, RANGE 1 WEST, WILLAMETTE MERIDIAN, CITY OF WILSONVILLE, CLACKAMAS COUNTY, OREGON
SHEET 12 OF 14

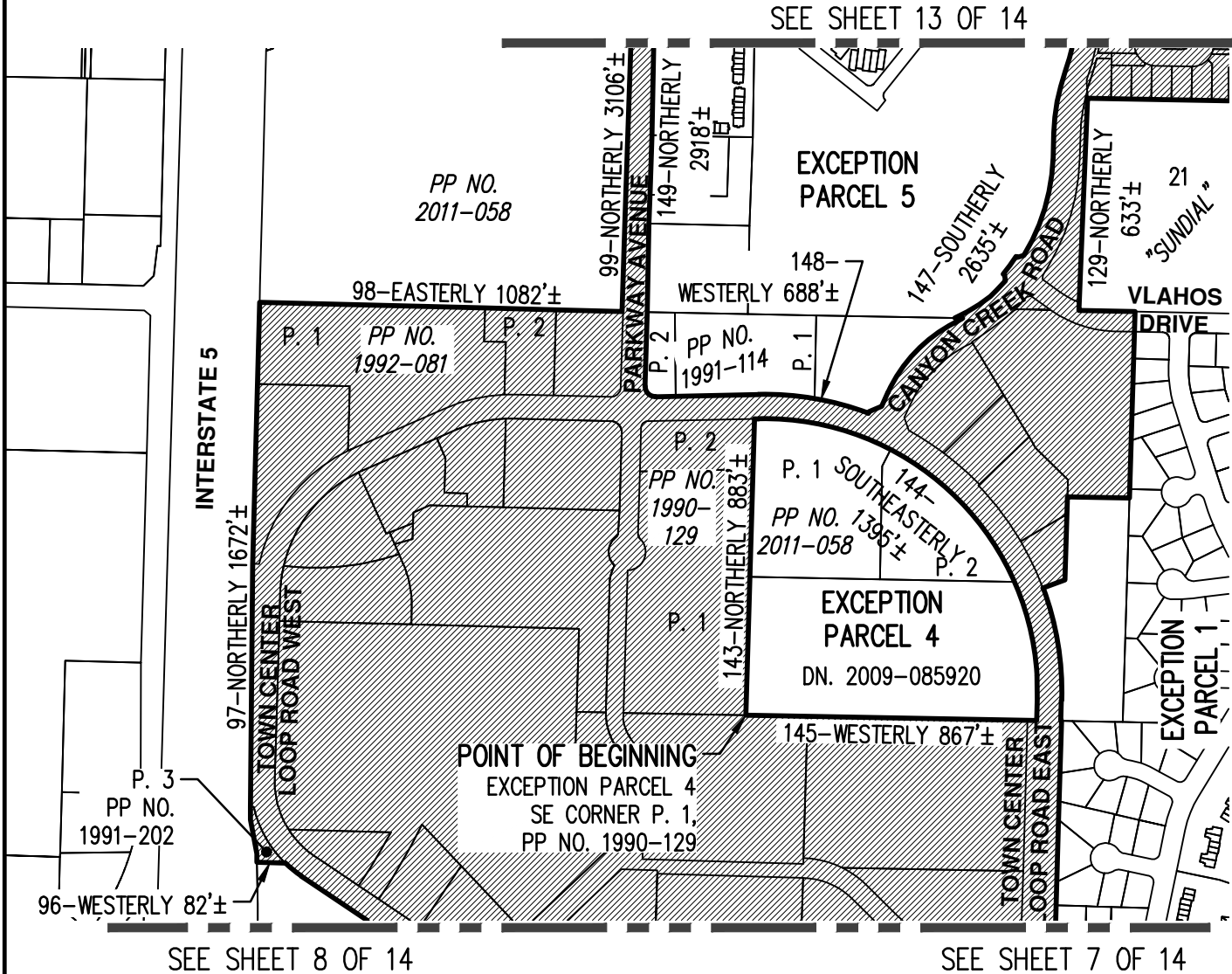

12/17/15

REGISTERED
PROFESSIONAL
LAND SURVEYOR

Nick White

OREGON
JANUARY 9, 2007
NICK WHITE
70652LS

RENEWS: 6/30/16

SCALE 1" = 500 FEET



500 0 200 300 400 500

CITY OF WILSONVILLE
URBAN RENEWAL DISTRICTS

AKS ENGINEERING & FORESTRY, LLC
12965 SW HERMAN RD, STE 100
TUALATIN, OR 97062
P: 503.563.6151 F: 503.563.6152 aks-eng.com



EXHIBIT
B

DRWN: MSK
CHKD: NSW
AKS JOB:
4658

EXHIBIT MAP

YEAR 2000 URBAN RENEWAL AREA

LOCATED IN SECTIONS 11, 12, 13, 14, 23, AND 24, TOWNSHIP 3 SOUTH, RANGE 1 WEST, WILLAMETTE MERIDIAN, CITY OF WILSONVILLE, CLACKAMAS COUNTY, OREGON
SHEET 13 OF 14

SEE SHEET 4 OF 14

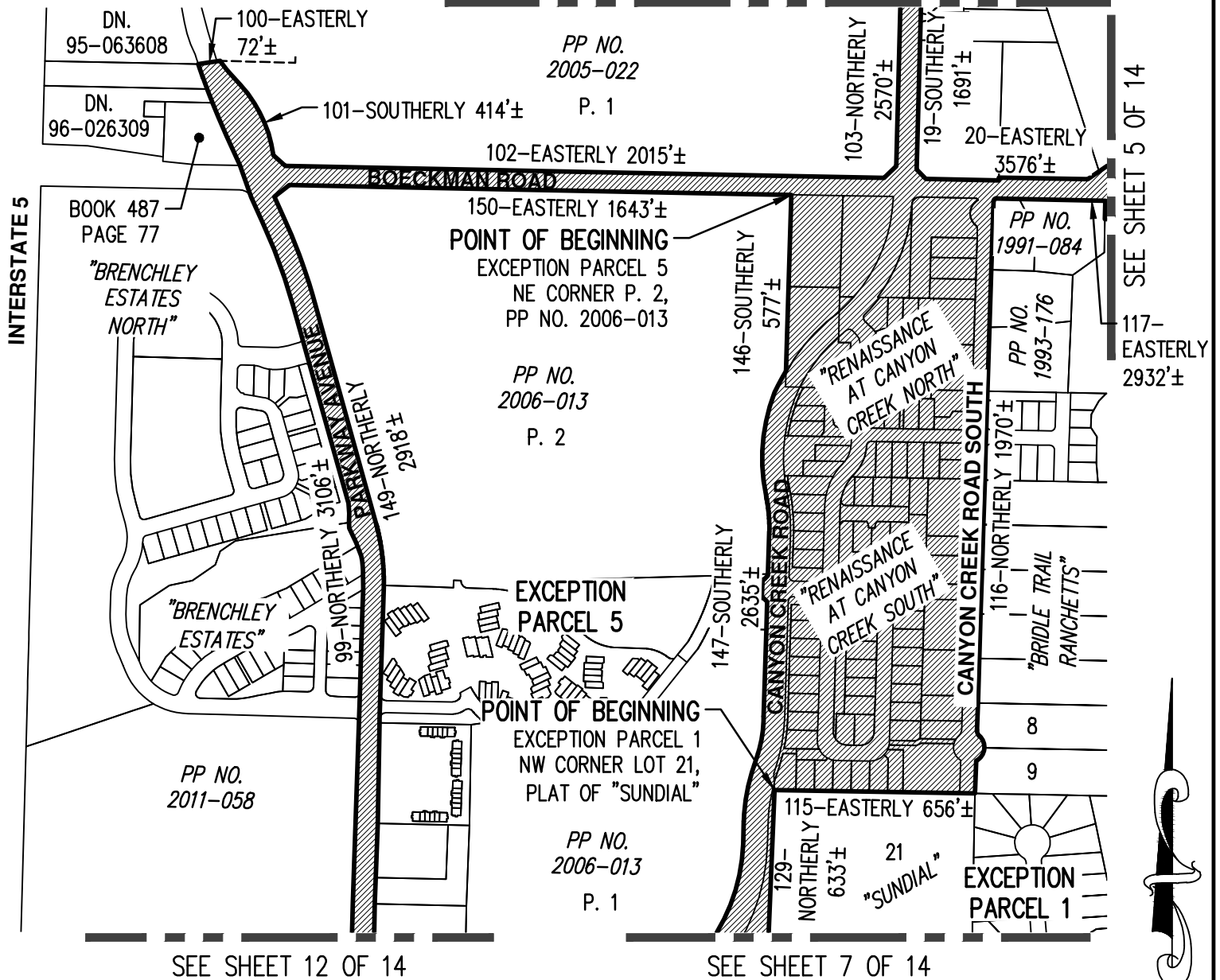

12/17/15

REGISTERED
PROFESSIONAL
LAND SURVEYOR

OREGON
JANUARY 9, 2007
NICK WHITE
70652LS

RENEWS: 6/30/16

SCALE 1" = 500 FEET



500 0 200 300 400 500

CITY OF WILSONVILLE
URBAN RENEWAL DISTRICTS

AKS ENGINEERING & FORESTRY, LLC
12965 SW HERMAN RD, STE 100
TUALATIN, OR 97062
P: 503.563.6151 F: 503.563.6152 aks-eng.com



EXHIBIT
B

DRWN: MSK
CHKD: NSW
AKS JOB:
4658

EXHIBIT MAP

YEAR 2000 URBAN RENEWAL AREA

LOCATED IN SECTIONS 11, 12, 13, 14, 23, AND 24,
TOWNSHIP 3 SOUTH, RANGE 1 WEST, WILLAMETTE MERIDIAN,
CITY OF WILSONVILLE, CLACKAMAS COUNTY, OREGON
SHEET 14 OF 14

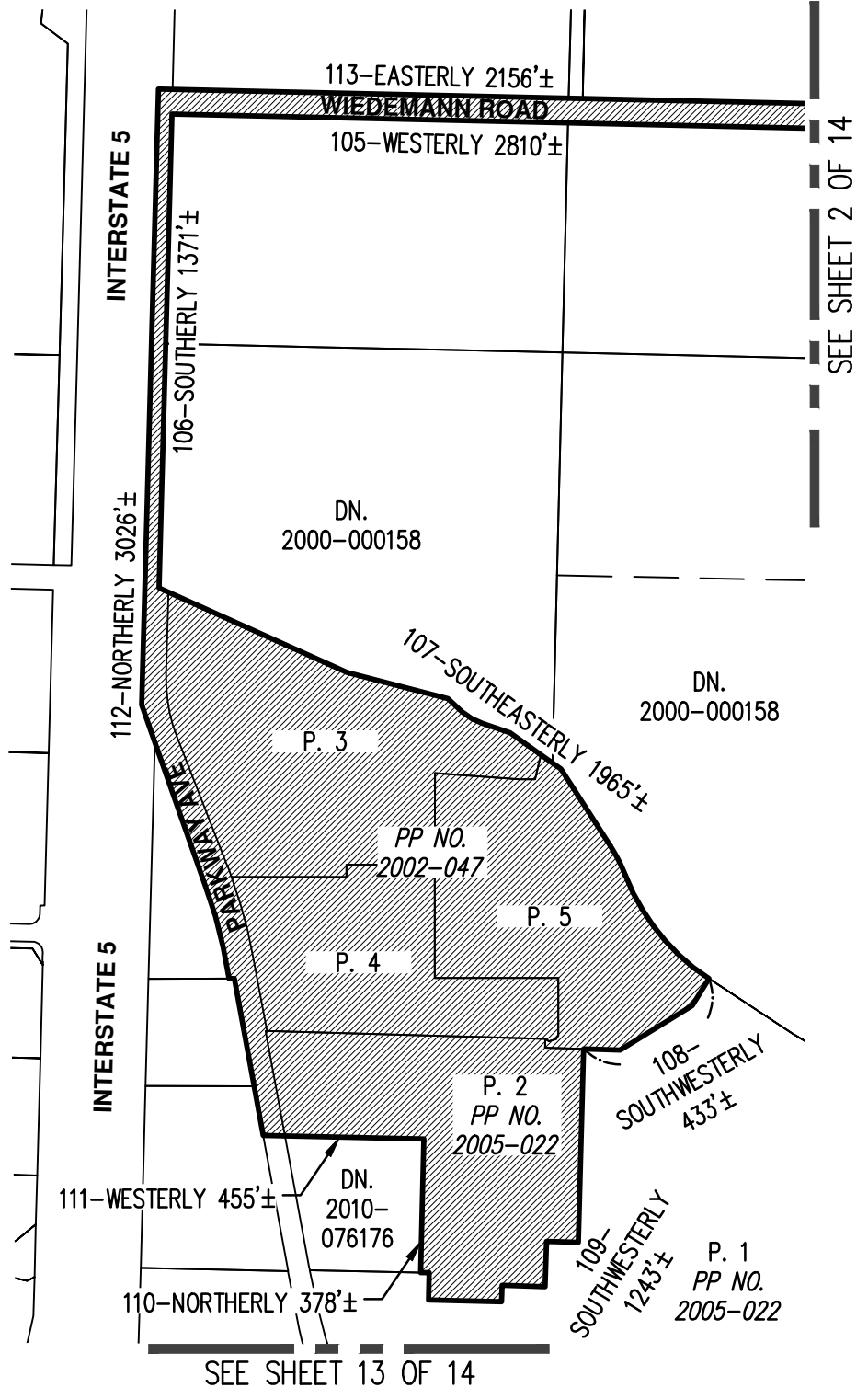
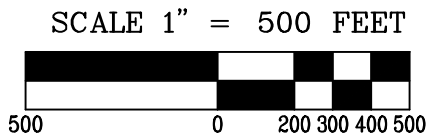

12/17/15

REGISTERED
PROFESSIONAL
LAND SURVEYOR

Nick White

OREGON
JANUARY 9, 2007
NICK WHITE
70652LS

RENEWS: 6/30/16

CITY OF WILSONVILLE
URBAN RENEWAL DISTRICTS

AKS ENGINEERING & FORESTRY, LLC
12965 SW HERMAN RD, STE 100
TUALATIN, OR 97062
P: 503.563.6151 F: 503.563.6152 aks-eng.com



EXHIBIT
B

DRWN: MSK
CHKD: NSW
AKS JOB:
4658

Report Accompanying the 10th Amendment to the Year 2000 Plan

Since this is not a substantial amendment, a full Report accompanying the Plan amendment is not required. However, to aid in understanding the additions and deletions, a partial report is included with this amendment.

I. Existing Physical, Social and Economic Conditions

The acreage to be added is 4.5 acres of undeveloped land in 5 parcels. There is no infrastructure in the parcels and there are no residences in the parcels. The county assessor will determine the assessed value of the parcels upon adoption of the amendment and transmission to the assessor's office. These parcels are shown in Figure 1.

Approximately 120.9 acres are scheduled to be removed from the Area to add value back to the property tax rolls to be distributed to all taxing districts and to free up acreage for potential new urban renewal; areas. The estimated assessed value to be added back to the tax rolls is \$570,000.

The net deletions total 116.4 acres (after adding the acreage to be added to the acreage to be deleted).

The Amendment to the Year 2000 Plan added acreage is shown in Figure 1. Deleted acreage is shown in Figures 2a – 2p. These are all shown in Table 1.

Table 1 - Acreage Changes

Acreage Changes	Acres Parcels	Acres ROW
Area to be Removed		
3S1W13CD – 02600	6.73	
3S1W24 TL -00601	8.85	
TL 31W24 00600	20.7	
TL 31W24 00602	1	
TL 31W24 01000	0.46	
3S1W23 CA 00100	1.68	
3S1W23DB 01100	1.1	
3S1W23 DB 01100	6	1
3S1W23 DB 01200	3.49	
3S1W23 DB 00100	6.88	
3S1W23 DB 00200	3.45	
ROW		10 Over 1-5 at Boeckman Road Bridge
TL 31W13B 02603	43.4	
TL 31W13B 02691	1.52	
31W14C 00801	1.57	
31W14C 00802	0.44	
ROW		3.3 Wilsonville Road
3S1W13b 02700	2.13	
Total to be Removed	109.4	11.50
Total to be Removed		120.9
Area to be Added		4.5
Net change		116.4

The Area after the Amendment is shown in Figure 3.

Figure 1 - Acreage to be Added



Figures 2a -2p - Acreage to be Deleted

Figure 2a - S1W13CD – 02600 - 6.73 acres



Figure 2b - 3S1W24 TL -00601 - 8.85 acres



Figure 2c - TL 31W24 00600 - 20.7 acres



Figure 2d - TL 31W24 00602 – 1 acre



Figure 2e - TL 31W24 01000 – .46 acres



Figure 2f - 3S1W23 CA 00100 - 1.68 acres



Figure 2g - 3S1W23DB 01100 - 1.1 acres



Figure 2h – 3S1W23 DB 01100 - 6 acres + R/W of approximately 1 acre



Figure 2i - 3S1W23 DB 01200 - 3.49 acres



Figure 2j - 3S1W23 DB 00100 - 6.88 acres



Figure 2k - 3S1W23 DB 00200 - 3.45 acres



Figure 2l - No Tax lot – ROW over I-5 at Boeckman Road bridge – approximately 10 acres



Figure 2m - TL 31W13B 02603 - 43.4 acres

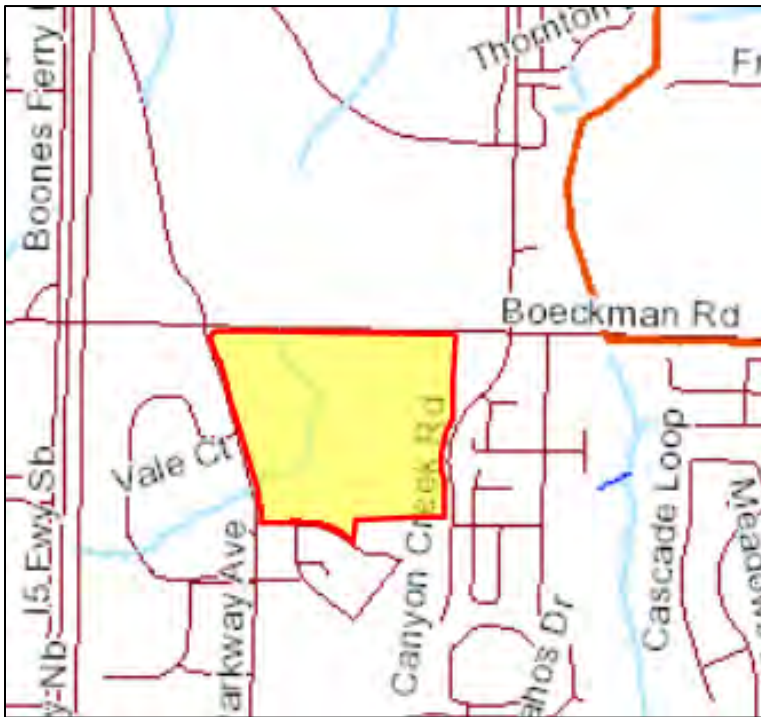

Figure 2n - TL 31W13B 02691 - 1.52 acres



Figure 2o - 31W14C 00801 - 1.57 acres, 31W14C 00802 - .44 acres, and Wilsonville Road ROW – approximately 3.3 acres

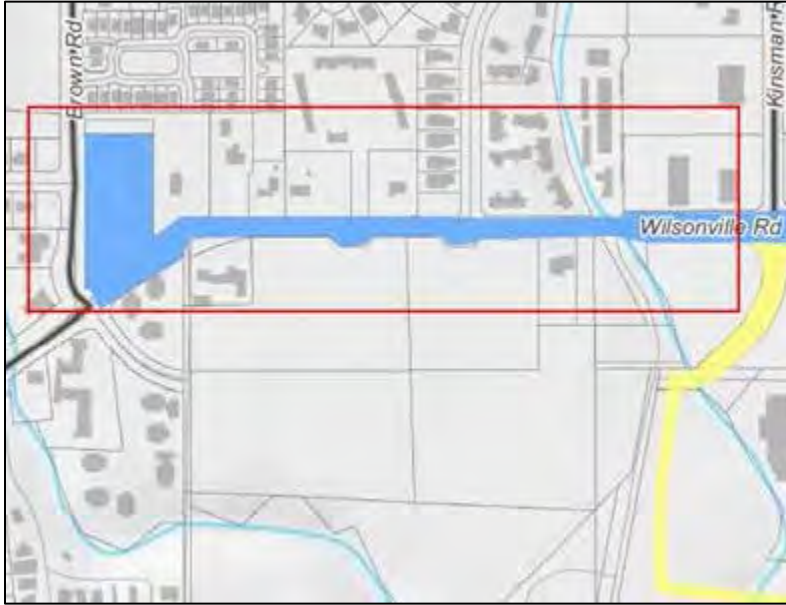
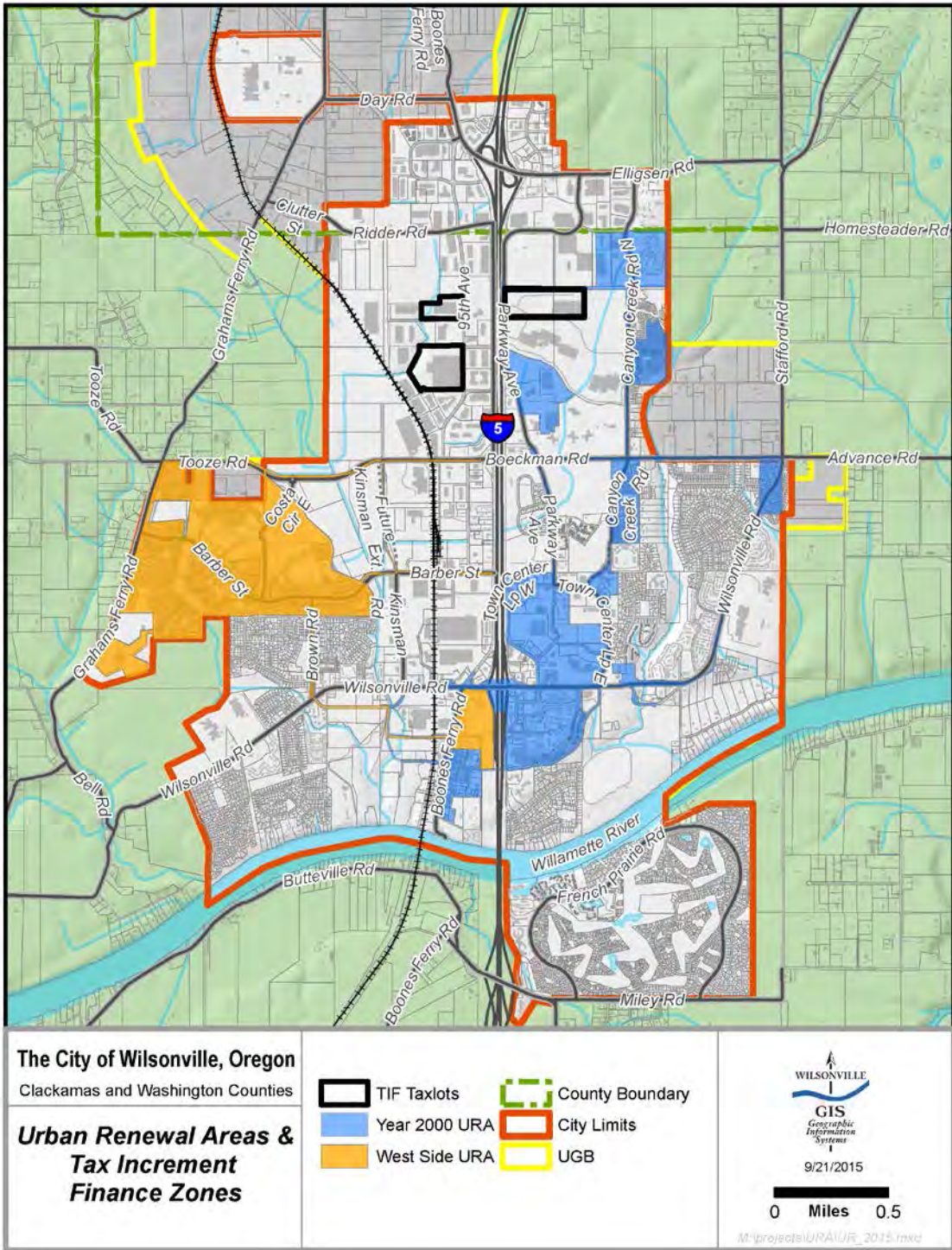

Figure 2p – 3S1W13b 02700 – 2.13 acres



Figure 3 – Year 2000 After Amendment



I. Reasons for Selection of Each Urban Renewal Area

The acreage to be added was selected as it is blighted and will allow for the future construction of the Old Town Escape transportation project.

II. The Relationship Between the Urban Renewal Projects and the Existing Conditions in the Urban Renewal Area.

Old Town Escape

The Old Town Escape is another transportation route to provide access out of the Old Town area. The present transportation route is often congested and is the only route in and out of the area. The property is presently vacant.

III. The Estimated Total Cost of Each Project and the Sources of Money to pay for Such Costs

The estimated cost for the Old Town Escape Project will depend on the route which is chosen in the future. The urban renewal participation is up to \$7,000,000 as designated in the Wilsonville Urban Renewal Plan Task Force Recommendations adopted in 2014.

IV. The Anticipated Completion Date for Each Project

The alignment for the Old Town Escape is expected to be determined in FY 2015/16. The project is expected to be constructed in from 2017-2019.

V. Financial Analysis

No increased maximum indebtedness is required. There is sufficient maximum indebtedness capacity to fund the \$7,000,000 allocated to the Old Town Escape project. The project does not change the life of the district beyond the currently anticipated closure in FY 2020/21 and will not impact the Agency's ability to continue to under-levy tax increment revenue in the district.

VI. Impact of the Tax Increment Financing

The added project, the Old Town Escape, is within the present maximum indebtedness capacity of the Area. The Area is receiving a set amount of tax increment on an annual basis (\$4 million) and this amount will not be increased as a result of this amendment.

VII. Compliance with Statutory Limits on Assessed Value and Size of Urban Renewal Area

State law limits the percentage of both a municipality’s total assessed value and the total land area that can be contained in an urban renewal area at the time of its establishment to 25% for municipalities under 50,000 in population. The Area complies with both the acreage and assessed value limitations. These estimates are based on changes after both the West Side and Year 2000 Amendments are adopted.

Table 2 - Urban Renewal Area Conformance with Assessed Value and Area Limits

Urban Renewal Area	Frozen Base/AV	Acres
West Side URA	\$16,109,831	415
Year 2000 URA	\$44,499,418	454
TIF Zones		
27255 SW 95th Ave	\$17,938,434	26.07
26440 SW Parkway	\$12,582,201	24.98
26755 SW 95th Ave	\$7,675,439	9.76
Total in URAs	\$98,805,323	929.81
City of Wilsonville*	\$2,429,384,903	4,805
Percent of Total	4.07%	19%

THE URBAN RENEWAL AGENCY OF THE CITY OF WILSONVILLE

URA RESOLUTION NO. 280

A RESOLUTION APPROVING THE YEAR 2000 URBAN RENEWAL PLAN 12TH AMENDMENT TO ADD PROPERTY, DELETE PROPERTY AND IDENTIFY PROPERTY TO BE ACQUIRED FOR THE 5TH STREET / KINSMAN ROAD EXTENSION PROJECT.

WHEREAS, the Year 2000 Urban Renewal Plan ("Original Plan") was adopted by the Wilsonville City Council (the "City Council") on August 29, 1990 by Ordinance No. 373 to provide tax increment funding and urban renewal authority to foster the development and redevelopment to protect the public health, safety, and welfare of the City of Wilsonville; and

WHEREAS, the Original Plan has been subsequently amended by the City Council eleven times (as amended, the "Plan"); and

WHEREAS, the Wilsonville City Council adopted the 10th Amendment to the Plan to add the "Old Town Escape" project to the Y2000 Plan of which the 5th Street / Kinsman Road Extension is one phase; and

WHEREAS, the 5th Street / Kinsman Road Extension project (the "Project") will extend 5th Street and the Ice Age Tonquin Trail from Boones Ferry Road to Arrowhead Creek Lane, extend Kinsman from Wilsonville Road to Wilsonville Concrete Products, and upgrade Boones Ferry Road to multi-modal urban standards; improve safety and area circulation for vehicular, pedestrian, and bicycle travel between Boones Ferry Road, Arrowhead Creek Lane and Wilsonville Road; and reconstruct Boones Ferry Road between Bailey Street and 5th Street with an additional bike lane and sidewalk, and meet long-term level of service needs; and

WHEREAS, the Project will provide an alternate route from Old Town to Wilsonville Road that does not rely on the Boones Ferry Road / Wilsonville Road intersection; and

WHEREAS, the Wilsonville Urban Renewal Agency ("Agency"), the duly organized and acting urban renewal agency of the City of Wilsonville has prepared an amendment to the Plan (the "12th Amendment") to add to the Plan properties or portions thereof to be acquired to complete the 5th Street / Kinsman Road Extension project; and

WHEREAS, the properties or portions thereof to be acquired to complete the 5th Street / Kinsman Road Extension project are identified in the Report on the Year 2000 Plan – 12th Amendment, attached hereto and incorporated herein; and

WHEREAS, the 12th Amendment also establishes a new Year 2000 Urban Renewal Area boundary that results from removing and adding property that is not necessary and necessary for the 5th Street / Kinsman Road Extension project; and

WHEREAS, the new boundary is detailed (legal description and maps) in Exhibit A to The Report on the Year 2000 Plan – 12th Amendment, attached hereto as **Exhibit 1** and incorporated herein; and

WHEREAS, the Report Accompanying the Year 2000 Urban Renewal Plan 12th Amendment – A Minor Amendment is attached hereto as **Exhibit 2** and incorporated herein; and

WHEREAS, the 12th Amendment is being adopted as a Minor Amendment pursuant to Section 1200 of the Plan; and

WHEREAS, the property being added is less than 1% of the existing area of the Plan and the amendment can be processed as a Minor Amendment per the acreage limitations of ORS 457.085; and

WHEREAS, Section 1200 of the Plan requires the Agency include a finding that the Minor Amendment is not a significant alteration to the Goals and Objectives of the Plan; and

WHEREAS, the 10th Amendment modified the Plan Goals and Objectives to include this project in the Plan; and

WHEREAS, the project is not being changed, and neither are the Goals and Objectives and therefore is not a significant alteration to the Goals and Objectives of the Plan; and

WHEREAS, the Agency has complied with all the requirements for adoption of the Minor Amendment under the Plan; and

NOW, THEREFORE, THE URBAN RENEWAL AGENCY OF THE CITY OF WILSONVILLE RESOLVES AS FOLLOWS:

1. Based on the above recitals, the City of Wilsonville Urban Renewal Agency does hereby adopt the Twelfth Amendment to the Year 2000 Urban Renewal Plan and Report attached hereto and incorporated herein as **Exhibits 1 and 2.**

2. This Resolution is effective upon adoption.

3. Upon adoption, a copy of this Resolution, Amendment and Report shall be sent to the County Assessor for their files.

ADOPTED by the Wilsonville Urban Renewal Agency at a regular meeting thereof this 15th day of October 2018 and filed with the Wilsonville City Recorder this date.



Scott Starr, BOARD MEMBER

ATTEST:

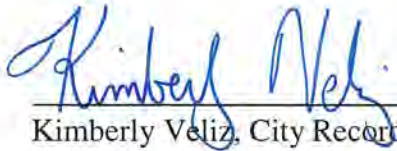

Kimberly Veliz, City Recorder

SUMMARY OF VOTES:

Board Chair Knapp	Recused
Board Member Starr	Yes
Board Member Lehan	Yes
Board Member Akervall	Yes
Board Member Stevens	Yes

Exhibits:

- Exhibit 1 – Year 2000 Urban Renewal Plan 12th Amendment
- Exhibit 2 – Report on the Year 2000 Plan 12th Amendment

Year 2000 Urban Renewal Plan 12th Amendment – A Minor Amendment

The following changes are made to the Year 2000 Urban Renewal Plan. Deletions are shown in ~~crossout~~ and additions are shown in *italics*.

PART ONE

SECTION 100 - INTRODUCTION

The 12th Amendment added property to allow for the completion of the Old Town Escape Project, deleted property not necessary for the construction of the Old Town Escape Project and identified the properties to be acquired for this project.

SECTION 300 - LEGAL DESCRIPTION BOUNDARY - Exhibit A

~~301 Exhibit A— Narrative Legal Description of Urban Renewal Area with Maps~~

Replaced in its entirety *by Exhibit A.*

~~302 Exhibit B— Graphic (Map) Description of Urban Renewal Area~~

Replaced in its entirety *by Exhibit A.*

SECTION 600 – URBAN RENEWAL ACTIVITIES

602 Acquisition of Real Property

E)(2) In order to construct the first phase of the 5th Street / Kinsman Road Extension project (aka Old Town Escape), acquisition for right-of-way and easements will be required from the following properties – all located within the City of Wilsonville, Clackamas County, Oregon:

<i>Property</i>	<i>Tax Lot</i>
<i>Property A</i>	<i>3 1W 23AB 01800</i>
<i>Property B</i>	<i>3 1W 23AB 01900</i>
<i>Property C</i>	<i>3 1W 23AB 02000</i>
<i>Property D</i>	<i>3 1W 23AB 02100</i>
<i>Property E</i>	<i>3 1W 23AC 03400</i>
<i>Property F</i>	<i>3 1W 23AC 03800</i>
<i>Property G</i>	<i>3 1W 23AC 04000</i>
<i>Property H</i>	<i>3 1W 23B 00100</i>
<i>Property I</i>	<i>3 1W 23B 00101</i>
<i>Property J</i>	<i>3 1W 23B 00600</i>
<i>Property K</i>	<i>3 1W 23B 00700-00790</i>
<i>Property L</i>	<i>3 1W 23B 00800</i>
<i>Property M</i>	<i>3 1W 23B 00900</i>
<i>Property N</i>	<i>3 1W 23B 01300</i>
<i>Property O</i>	<i>3 1W 23B 01700</i>
<i>Property P</i>	<i>3 1W 23BD 00101</i>

Property Q	3 1W 23BD 00102
Property R	3 1W 23BD 00103
Property S	3 1W 23BD 00104
Property Y	3 1W 23BD 00200
Property U	3 1W 23BD 00300
Property V	3 1W 23BD 00400
Property W	3 1W 23BD 00600
Property X	3 1W 23BD

PART TWO

EXHIBITS – YEAR 2000 PLAN

8. 5TH STREET TO KINSMAN ROAD EXTENSION PROPERTY ACQUISITION

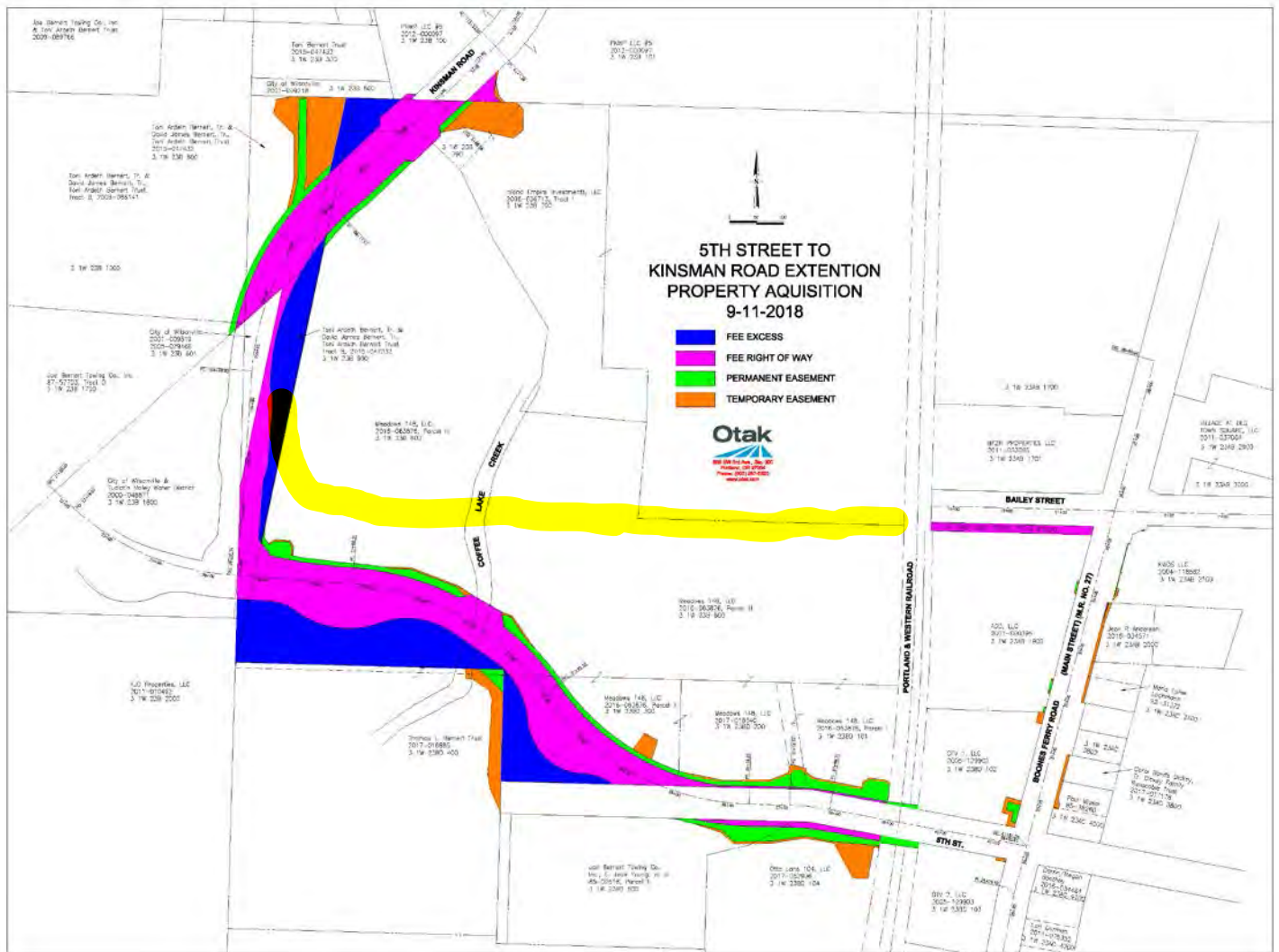

Exhibit 1 – Year 2000 Urban Renewal Plan 12th Amendment
 Page 2



EXHIBIT A

Legal Description

Year 2000 Urban Renewal Area
Wilsonville, Oregon

A tract of land located in Sections 11, 12, 13, 14, 23, and 24 of Township 3 South, Range 1 West, Willamette Meridian, City of Wilsonville, Clackamas County, Oregon, and being more particularly described as follows:

Beginning at the Section corner common to Sections 1, 2, 11, and 12 of Township 3 South, Range 1 West, Willamette Meridian, in the City of Wilsonville, Clackamas County, Oregon (Assessor's Map 3 1W 12):

1. Thence along the north section line of said Section 12, Easterly 990 feet, more or less, to the intersection of the northerly extension of the west line of Partition Plat Number 1991-159, being the True Point of Beginning (Assessor's Map 3 1W 12);
2. Thence continuing along said north section line, Easterly 1672 feet, more or less, to the north one-quarter corner of said Section 12 (Assessor's Map 3 1W 12);
3. Thence along the north-south centerline of said Section 12, Southerly 1289 feet, more or less, to the northerly right-of-way line of Wiedemann Road (Assessor's Map 3 1W 12);
4. Thence along said northerly right-of-way line and the westerly extension thereof, Westerly 821 feet, more or less, to the northerly extension of the easterly right-of-way line of Canyon Creek Road North (Assessor's Map 3 1W 12);
5. Thence along said easterly right-of-way line and the northerly extension thereof, Southerly 1128 feet, more or less, to the westerly northwest corner of Lot 1 of the Plat of "Canyon Creek Estates," also being on the southerly right-of-way line of Roanoke Drive South (Assessor's Map 3 1W 12BD);
6. Thence along said southerly right-of-way line, Easterly 506 feet, more or less, to the southerly extension of the easterly right-of-way line of McLeod Street (Assessor's Map 3 1W 12BD);
7. Thence along said easterly right-of-way line and the southerly extension thereof, Northerly 465 feet, more or less, to the southerly right-of-way line of Roanoke Drive North (Assessor's Map 3 1W 12BD);
8. Thence along said southerly right-of-way line, Southeasterly 159 feet, more or less, to the most northerly corner of Lot 72 of said Plat (Assessor's Map 3 1W 12BD);
9. Thence Northeasterly 39 feet, more or less, to the intersection of the northerly right-of-way line of Roanoke Drive North and the most southerly corner of Tract 'M' of said plat (Assessor's Map 3 1W 12BD);
10. Thence along the southerly line of said Tract 'M', Northeasterly 122 feet, more or less, to the most northerly corner of Lot 28 of said Plat (Assessor's Map 3 1W 12BD);

11. Thence along the easterly line of said Lot 28 and the easterly lines of Lots 27, 26, and 25 of said Plat, Southerly 210 feet, more or less, to the southeasterly corner of said Lot 25 (Assessor's Map 3 1W 12BD);
12. Thence along the southwesterly line of said Lot 25, Southwesterly 90 feet, more or less, to the easterly right-of-way line of Roanoke Drive North (Assessor's Map 3 1W 12BD);
13. Thence along said easterly right-of-way line, Southeasterly 15 feet, more or less, to the northwesterly corner of Lot 24 of said Plat (Assessor's Map 3 1W 12BD);
14. Thence along the northwesterly line of said Lot 24, Northeasterly 90 feet, more or less, to the northeasterly corner of said Lot 24 (Assessor's Map 3 1W 12BD);
15. Thence along the northeasterly line of said Lot 24 and the northeasterly lines of Lots 23, 22, and 21, Southeasterly 225 feet, more or less, to the north-south centerline of said Section 12 (Assessor's Map 3 1W 12BD);
16. Thence along said north-south centerline, Southerly 1008 feet, more or less, to the easterly southeast corner of Tract 'R' of the Plat of "Canyon Creek Meadows" (Assessor's Map 3 1W 12CA);
17. Thence along the southeasterly line of said Tract 'R', Southwesterly 196 feet, more or less, to the south line of said Plat (Assessor's Map 3 1W 12CA);
18. Thence along said south line, Westerly 771 feet, more or less, to the easterly right-of-way line of Canyon Creek Road North (Assessor's Map 3 1W 12CA);
19. Thence along said easterly right-of-way line, Southerly 1691 feet, more or less, to the northerly right-of-way line of Boeckman Road (Assessor's Map 3 1W 12D);
20. Thence along said northerly right-of-way line and the easterly extension thereof, Easterly 3576 feet, more or less, to the east line of said Section 12 (Assessor's Map 3 1W 12D);
21. Thence along said east line, Southerly 30 feet, more or less, to the section corner common to Sections 12 and 13, Township 3 South, Range 1 West, and Sections 7 and 18, Township 3 South, Range 1 East (Assessor's Map 3 1W 13);
22. Thence along the east line of Section 13, Township 3 South, Range 1 West, Southerly 1317 feet, more or less, to the North 1/16th corner common to said Sections 13 and 18 (Assessor's Map 3 1W 13AA);
23. Thence along the south line of the Northeast One-Quarter of the Northeast One-Quarter of said Section 13, Westerly 479 feet, more or less, to the westerly line of Lot 44 of the plat of "Landover" (Assessor's Map 3 1W 13AA);
24. Thence along said westerly line, Northerly 86 feet, more or less, to the southerly right-of-way line of SW Wagner Street (Assessor's Map 3 1W 13AA);
25. Thence along said southerly right-of-way line, Southwesterly 26 feet, more or less, to the easterly right-of-way line of Wilsonville Road (Assessor's Map 3 1W 13AA);
26. Thence along said easterly right-of-way line and the southerly right-of-way lines of Wilsonville Road, Southwesterly 5871 feet, more or less, to the easterly right-of-way line of Kolbe Lane (Assessor's Map 3 1W 24);
27. Thence along said easterly right-of-way line, Southerly 141 feet, more or less, to the most northerly corner of Document Number 92-076392 (Assessor's Map 3 1W 24);
28. Thence along the easterly lines of said Deed, Southerly 286 feet, more or less, to the northerly right-of-way line of said Kolbe Lane (Assessor's Map 3 1W 24);

29. Thence along said northerly right-of-way line, Easterly 407 feet, more or less, to the point of tangency of said right-of-way line (Assessor's Map 3 1W 24);
30. Thence Southerly 56 feet, more or less, to the southwesterly corner of Document Number 2017-023602, being on the southerly right-of-way line of said Kolbe Lane (Assessor's Map 3 1W 24A);
31. Thence along said southerly right-of-way line, Westerly 1089 feet, more or less, to the southerly right-of-way line of Wilsonville Road (Assessor's Map 3 1W 24);
32. Thence along said southerly right-of-way line, Westerly 580 feet, more or less, to the easterly right-of-way line of Memorial Drive (Assessor's Map 3 1W 24);
33. Thence along the easterly and southerly right-of-way lines of Memorial Drive, Southwesterly 3337 feet, more or less, to the northwesterly corner of Parcel 1 of Partition Plat Number 1999-017 (Assessor's Map 3 1W 24CB);
34. Thence Westerly 592 feet, more or less, to the intersection of the east line of the Thomas Bailey Donation Land Claim No. 45 and the southerly right-of-way line of 5th Street (Assessor's Map 3 1W 23AC);
35. Thence along said east Donation Land Claim line, Southerly 616 feet, more or less, to the southeast corner of Document Number 96-084506 (Assessor's Map 3 1W 23AC);
36. Thence along the southerly line of said Deed and the northerly line of Document Number 71-32182 and Document Number 93-64436, Westerly 592 feet, more or less, to the easterly right-of-way line of Magnolia Avenue (Assessor's Map 3 1W 23DB);
37. Thence along said easterly right-of-way line, Southerly 271 feet, more or less, to the northerly line of Document Number 2005-093982 (Assessor's Map 3 1W 23DB);
38. Thence along said northerly line, Easterly 110 feet, more or less, to the northeast corner of said Deed (Assessor's Map 3 1W 23DB);
39. Thence along the easterly line of said Deed, Southerly 333 feet, more or less, to the northerly right-of-way line of Tauchman Street (Assessor's Map 3 1W 23DB);
40. Thence along said northerly right-of-way line, Southeasterly 245 feet, more or less, to the westerly line of Document Number 71-32182 (Assessor's Map 3 1W 23DB);
41. Thence along said westerly line, Southerly 33 feet, more or less, to the southerly right-of-way line of said Tauchman Street (Assessor's Map 3 1W 23DB);
42. Thence along said southerly right-of-way line, Northwesterly 665 feet, more or less, to the easterly right-of-way line of Boones Ferry Road (Main Street, Market Road No. 27) (Assessor's Map 3 1W 23DB);
43. Thence along said easterly right-of-way line, Southeasterly 643 feet, more or less, to the Ordinary High Water Line of the Willamette River (Assessor's Map 3 1W 23DB);
44. Thence along said Ordinary High Water Line, Westerly 63 feet, more or less, to the westerly right-of-way line of said Boones Ferry Road (Assessor's Map 3 1W 23DB);
45. Thence along said westerly right-of-way line, Northwesterly 848 feet, more or less, to the southerly right-of-way line of 2nd Street (Assessor's Map 3 1W 23CA);
46. Thence along said southerly right-of-way line, Westerly 177 feet, more or less, to the northwest corner of Lot 2, Block J of the plat of "Wilsonville" (Assessor's Map 3 1W 23CA);
47. Thence Northerly 48 feet, more or less, to the intersection of northerly right-of-way line of said 2nd Street and the southerly extension of the westerly line of Lot 2, Block H of the plat of "Wilsonville" (Assessor's Map 3 1W 23BD);

48. Thence along said northerly right-of-way line, Easterly 181 feet, more or less, to the westerly right-of-way line of Boones Ferry Road (Assessor's Map 3 1W 23BD);
49. Thence along said westerly right-of-way line, Northerly 938 feet, more or less, to the southerly right-of-way line of 5th Street (Assessor's Map 3 1W 23BD);
50. Thence along said southerly right-of-way line and the westerly extension thereof, Westerly 954 feet, more or less, to the easterly line of Document Number 90-020013 (Assessor's Map 3 1W 23BD);
51. Thence along said easterly line, Northerly 60 feet, more or less, to the southerly line of Document Number 2016-063876 (Assessor's Map 3 1W 23BD);
52. Thence along said southerly line, Easterly 212 feet, more or less, to the southwesterly right-of-way line of the 5th Street extension (Assessor's Map 3 1W 23BD);
53. Thence along said southwesterly right-of-way line, Northwesterly 1181 feet, more or less, to the southerly line of an existing service road (Assessor's Map 3 1W 23B);
54. Thence along said southeasterly line, Southwesterly 91 feet, more or less, to a point which bears easterly 80 feet, more or less, from a service bridge (Assessor's Map 3 1W 23B);
55. Thence leaving said southerly line, Northerly 26 feet, more or less, to the northerly line of said service road (Assessor's Map 3 1W 23B);
56. Thence along said northerly line, Northeasterly 170 feet, more or less, to the northeasterly right-of-way line of the 5th Street extension (Assessor's Map 3 1W 23B);
57. Thence along said northeasterly right-of-way line, Easterly 201 feet, more or less, to the westerly right-of-way line of the Kinsman Road extension (Assessor's Map 3 1W 23B);
58. Thence along said westerly right-of-way line, Northeasterly 755 feet, more or less, to a line parallel with and 30.00 feet westerly of the most westerly line of Parcel 1 of Partition Plat Number 1990-092 (Assessor's Map 3 1W 23B);
59. Thence along said parallel line, Southerly 173 feet, more or less, to the easterly right-of-way line of the Kinsman Road extension (Assessor's Map 3 1W 23B);
60. Thence along said easterly right-of-way line, Southerly 541 feet, more or less to the northerly right-of-way line of the 5th Street extension (Assessor's Map 3 1W 23B);
61. Thence along said northerly right-of-way line, and the northerly right-of-way line of 5th Street, Easterly 1555 feet, more or less to the westerly right-of-way line of the Boones Ferry Road (Assessor's Map 3 1W 23B);
62. Thence along said westerly right-of-way line, Northerly 897 feet, more or less, to the southerly right-of-way line of Bailey Street (Assessor's Map 3 1W 23BD);
63. Thence along said southerly right-of-way line, Easterly 98 feet, more or less, to the easterly right-of-way line of Boones Ferry Road (Assessor's Map 3 1W 23AB);
64. Thence along said easterly right-of-way line, Southerly 295 feet, more or less to the north line of the plat of "Wilsonville" (Assessor's Map 3 1W 23AC);
65. Thence along said north line, Easterly 743 feet, more or less, to the westerly line of a 25 foot wide Public Road per Document Number 2003-04532 (Assessor's Map 3 1W 23AC);
66. Thence along the west line of said Public Road, Southerly 435 feet, more or less, to the northerly right-of-way line of 5th Street (Assessor's Map 3 1W 23AC);

67. Thence Southeasterly 43 feet, more or less, to the southwest corner of Parcel 2 of Partition Plat Number 2000-83 (Assessor's Map 3 1W 23AC);
68. Thence along the south line of said plat and the easterly extension thereof, Easterly 528 feet, more or less, to the easterly right-of-way line of Interstate 5 (Assessor's Map 3 1W 23A);
69. Thence along said easterly right-of-way line, Northerly 1312 feet, more or less, to the northwest corner of Document Number 96-027391 (Assessor's Map 3 1W 23AA);
70. Thence along the westerly extension of the northerly line of Document Number 96-027391, Westerly 339 feet, more or less, to the westerly right-of-way line of said Interstate 5 (Assessor's Map 3 1W 23AB);
71. Thence along said westerly right-of-way line, Northerly 529 feet, more or less, to the southerly right-of-way line of Wilsonville Road (Assessor's Map 3 1W 23AB);
72. Thence westerly along said southerly right-of-way line, Westerly 569 feet, more or less, to the easterly right-of-way line of Boones Ferry Road (Assessor's Map 3 1W 23AB);
73. Thence along said easterly right-of-way line, Southerly 1073 feet, more or less, to the northerly right-of-way line of Bailey Street (Assessor's Map 3 1W 23AB);
74. Thence along said northerly right-of-way line, Westerly 105 feet, more or less, to the westerly right-of-way line of Boones Ferry Road (Assessor's Map 3 1W 23AB);
75. Thence along said westerly right-of-way line, Northerly 1022 feet, more or less, to the southerly right-of-way line of SW Wilsonville Road (Assessor's Map 3 1W 23AB);
76. Thence along said southerly right-of-way line, Westerly 1235 feet, more or less, to the easterly right-of-way line of Kinsman Road (Assessor's Map 3 1W 23AB);
77. Thence along said easterly and southeasterly right-of-way line, Southwesterly 888 feet, more or less, to a line parallel with and 30.00 feet easterly of the most westerly line of Parcel 1 of Partition Plat Number 1990-092 (Assessor's Map 3 1W 23B);
78. Thence along said parallel line, Northerly 132 feet, more or less, to the northwesterly right-of-way line of the Kinsman Road extension (Assessor's Map 3 1W 23B);
79. Thence along said northwesterly right-of-way line, northeasterly 594 feet, more or less, to the intersection of the westerly right-of-way line of Kinsman Road and the southerly right-of-way line of SW Wilsonville Road (Assessor's Map 3 1W 23B);
80. Thence Northerly 99 feet, more or less, to the intersection of the northerly right-of-way line of said Wilsonville Road and the westerly right-of-way line of said Kinsman Road (Assessor's Map 3 1W 14C);
81. Thence along said northerly right-of-way line, Easterly 1043 feet, more or less, to the southwest corner of Document Number 2011-056296 (Assessor's Map 3 1W 14D);
82. Thence along the westerly line of said Deed, Northerly 131 feet, more or less, to the northwesterly corner of said Deed (Assessor's Map 3 1W 14D);
83. Thence along the northerly and easterly lines of said Deed, Easterly 200 feet, more or less, to the northwesterly corner of Document Number 2014-044714 (Assessor's Map 3 1W 14D);
84. Thence along the northerly and easterly lines of said Deed, Southeasterly 156 feet, more or less, to the northerly right-of-way line of said Wilsonville Road (Assessor's Map 3 1W 14D);

85. Thence along said northerly right-of-way line, Easterly 193 feet, more or less, to the westerly right-of-way line of Boones Ferry Road (Assessor's Map 3 1W 14D);
86. Thence along said westerly right-of-way line, Northeasterly 291 feet, more or less, to the easterly southeast corner of Parcel 2 of Partition Plat Number 2003-082 (Assessor's Map 3 1W 14D);
87. Thence along a line perpendicular to the said westerly right-of-way line, Southeasterly 82 feet, more or less, to the easterly right-of-way line of said Boones Ferry Road (Assessor's Map 3 1W 14D);
88. Thence along said easterly right-of-way line, Southerly 259 feet, more or less, to the northerly right-of-way line of Wilsonville Road (Assessor's Map 3 1W 14D);
89. Thence along said northerly right-of-way line, Easterly 125 feet, more or less, to the southeasterly corner of Document Number 96-020104 (Assessor's Map 3 1W 14D);
90. Thence along the southeasterly line of said Deed, Northeasterly 274 feet, more or less, to the southwesterly corner of Parcel 2 of Partition Plat Number 2007-121 (Assessor's Map 3 1W 14D);
91. Thence along the southerly line of said Parcel 2, Easterly 28 feet, more or less, to the westerly right-of-way line of Interstate 5 (Assessor's Map 3 1W 14D);
92. Thence Easterly 631 feet, more or less, to the easterly right-of-way line of said Interstate 5 and the southerly corner of Document Number 2013-033879, also being the northerly right-of-way line of Wilsonville Road (Assessor's Map 3 1W 14D);
93. Thence along said northerly right-of-way line, Easterly 543 feet, more or less, to the westerly right-of-way line of Town Center Loop Road West (Assessor's Map 3 1W 14D);
94. Thence along said westerly right-of-way line, Northwesterly 1227 feet, more or less, to the southerly line of Parcel 3 of Partition Plat Number 1991-202 (Assessor's Map 3 1W 14D);
95. Thence along said southerly line, Westerly 82 feet, more or less, to the easterly right-of-way line of said Interstate 5 (Assessor's Map 3 1W 14D);
96. Thence along said easterly right-of-way line, Northerly 1672 feet, more or less, to the southerly line of Partition Plat Number 2011-058 (Assessor's Map 3 1W 14A);
97. Thence along said southerly line, Easterly 1082 feet, more or less, to the westerly right-of-way line of Parkway Avenue (Assessor's Map 3 1W 14A);
98. Thence along said westerly right-of-way line, Northerly 3106 feet, more or less, to the southeast corner of Document Number 2017-004284 (Assessor's Map 3 1W 11);
99. Thence Easterly 72 feet, more or less, to the most westerly northwest corner of Parcel 1 of Partition Plat Number 2005-022, being on the easterly right-of-way line of Parkway Avenue (Assessor's Map 3 1W 12);
100. Thence along said easterly right-of-way line, Southerly 414 feet, more or less, to the northerly right-of-way line of Boeckman Road (Assessor's Map 3 1W 12);
101. Thence along said northerly right-of-way line, Easterly 2015 feet, more or less, to the westerly right-of-way line of Canyon Creek Road (Assessor's Map 3 1W 12);
102. Thence along said westerly right-of-way line, Northerly 2570 feet, more or less, to the intersection of the east-west centerline of Section 12 (Assessor's Map 3 1W 12);
103. Thence leaving said right-of-way line, along a line parallel with the west line of Parcel 4 of Document Number 2000-000158, North 01°30'22" East 1278 feet, more

- or less, to the southerly right-of-way line of Wiedemann Road (Assessor's Map 3 1W 12);
104. Thence along said southerly right-of-way line, Westerly 2810 feet, more or less, to the easterly right-of-way line of Parkway Avenue (Assessor's Map 3 1W 11);
 105. Thence along said easterly right-of-way line, Southerly 1371 feet, more or less, to the northerly line of Partition Plat Number 2002-047 (Assessor's Map 3 1W 11D);
 106. Thence along the northerly lines of Parcel 3 and Parcel 5 of said Partition Plat, Southeasterly 1965 feet, more or less, to the most easterly corner of said Parcel 5 (Assessor's Map 3 1W 11D);
 107. Thence along the southeasterly line of said Parcel 5, Southwesterly 433 feet, more or less, to the northeasterly corner of Parcel 2 of Partition Plat Number 2005-022 (Assessor's Map 3 1W 12);
 108. Thence along the easterly and southerly lines of said Parcel 2, Southwesterly 1243 feet, more or less, to the southeasterly corner of Document Number 2010-076176 (Assessor's Map 3 1W 11);
 109. Thence along the easterly line of said Deed, Northerly 378 feet, more or less, to the westerly south line of Parcel 2 of Partition Plat Number 2005-022 (Assessor's Map 3 1W 12);
 110. Thence along said southerly line and the westerly extension thereof, Westerly 455 feet, more or less, to the westerly right-of-way line of Parkway Avenue (Assessor's Map 3 1W 11D);
 111. Thence along said westerly right-of-way line, Northerly 3026 feet, more or less, to the westerly extension of the northerly right-of-way line of Wiedemann Road (Assessor's Map 3 1W 11);
 112. Thence along said northerly right-of-way line and the westerly extension thereof, Easterly 2156 feet, more or less, to the southwest corner of Parcel 1 of Partition Plat Number 1993-133 (Assessor's Map 3 1W 12);
 113. Thence along the west line of said Parcel 1 and the west line of Parcel 1 of Partition Plat Number 1991-159 and the northerly extension thereof, Northerly 1287 feet, more or less, to the True Point of Beginning.

Excepting the following parcels:

Parcel 1:

Beginning at the northwest corner of Lot 21 of the Plat of "Sundial" (Assessor's Map 3 1W 13BD):

150. Thence along the northerly line of said Plat, Easterly 656 feet, more or less, to the easterly right-of-way line of Canyon Creek Road South (Assessor's Map 3 1W 13BD);
151. Thence along said easterly right-of-way line, Northerly 1970 feet, more or less, to the southerly right-of-way line of Boeckman Road (Assessor's Map 3 1W 13B);
152. Thence along said southerly right-of-way line, Easterly 2932 feet, more or less, to the northwesterly corner of Lot 86 of the plat of "Landover No. 2" (Assessor's Map 3 1W 13AA);

153. Thence along the westerly line of said Lot 86, Southerly 28 feet, more or less, to a point on the westerly line of the vacated right-of-way line of Wilsonville Road per Document Number 96-012470 (Assessor's Map 3 1W 13AA);
154. Thence along said westerly line, Southerly 1103 feet, more or less to the south line of Lot 111 of said Plat (Assessor's Map 3 1W 13AA);
155. Thence along said southerly line, Southeasterly 5 feet, more or less, to the westerly right-of-way line of Wilsonville Road (Assessor's Map 3 1W 13AA);
156. Thence along said westerly right-of-way line, Southwesterly 5567 feet, more or less, to the southeasterly corner of Parcel 2 of Partition Plat Number 2009-072 (Assessor's Map 3 1W 13CD);
157. Thence along the easterly line of said Parcel 2, Northerly 426 feet, more or less, to the northeasterly corner of said Parcel 2 (Assessor's Map 3 1W 13CD);
158. Thence along the northerly line of said Parcel 2 and the northerly line of Parcel 1 of said Plat, Westerly 599 feet, more or less, to the easterly right-of-way line of Town Center Loop Road East (Assessor's Map 3 1W 13CD);
159. Thence along said easterly right-of-way line, Northerly 1291 feet, more or less, to the most southerly southwest corner of Partition Plat Number 1991-166 (Assessor's Map 3 1W 13CB);
160. Thence along the southerly and easterly line of said plat, Northeasterly 318 feet, more or less, to the northwesterly corner of Parcel 3 of Partition Plat Number 1990-114 (Assessor's Map 3 1W 13CB);
161. Thence along the northerly line of said Parcel 3, Easterly 185 feet, more or less, to the westerly line of the Plat of "Courtside Estates" (Assessor's Map 3 1W 13CB);
162. Thence along said westerly line and the northerly extension thereof, Northerly 556 feet, more less, to the northerly right-of-way line of Vlahos Drive (Assessor's Map 3 1W 13BD);
163. Thence along said northerly right-of-way line, Westerly 167 feet, more or less, to the southwest corner of Lot 21 of the plat of "Sundial" (Assessor's Map 3 1W 13BD);
164. Thence along the westerly line of said Lot 21, Northerly 633 feet, more or less, to the Point of Beginning.

Parcel 2:

Beginning at northeast corner of Lot 5 of the Plat of "Main Street Village," also being on the southerly right-of-way line of Wilsonville Road (Assessor's Map 3 1W 24):

175. Thence along said southerly right-of-way line, Easterly 383 feet, more or less, to the westerly right-of-way line of Memorial Drive (Assessor's Map 3 1W 24);
176. Thence along said westerly right-of-way line, Southwesterly 660 feet, more or less, to the northerly line of the Plat of "Village Estates Condominium Stage 2" (Assessor's Map 3 1W 23AD-2);
177. Thence along said northerly line, Northwesterly 125 feet, more or less, to the southerly extension of the easterly line of said Lot 5 (Assessor's Map 3 1W 23A);
178. Thence along the easterly line of said Lot 5 and the southerly extension thereof, Northerly 509 feet, more or less, to the Point of Beginning.

Parcel 3:

Beginning at the southeast corner of Parcel 1 of Partition Plat Number 1990-129 (Assessor’s Map 3 1W 23B):

- 180. Thence along the easterly line of said Parcel, and the northerly extension thereof, Northerly 883 feet, more or less, to the southerly right-of-way line of Town Center Loop Road East (Assessor’s map 3 1W 13CB);
- 181. Thence along the southerly right-of-way line and the southwesterly right-of-way line of Town Center Loop Road East, Southeasterly 1395 feet, more or less, to the southerly line of Document Number 2009-085920 (Assessor’s Map 3 1W 13CB);
- 182. Thence along said southerly line, Westerly 867 feet, more or less, to the Point of Beginning;

Parcel 4:

Beginning at the northeast corner of Parcel 2 of Partition Plat Number 2006-013, also being on the southerly right-of-way line of Boeckman Road (Assessor’s Map 3 1W 13B):

- 200. Thence along the easterly line of said Parcel 2, Southerly 577 feet, more or less, to the westerly right-of-way line of Canyon Creek Road (Assessor’s Map 3 1W 13B);
- 201. Thence along said westerly right-of-way line, Southerly 2635 feet, more or less, to the northerly right-of-way line of Town Center Loop Road East (Assessor’s Map 3 1W 13CB);
- 202. Thence along said northerly right-of-way line, Westerly 688 feet, more or less, to the easterly right-of-way line of Parkway Avenue (Assessor’s Map 3 1W 13CB);
- 203. Thence along said easterly right-of-way line, Northerly 2918 feet, more or less, to the southerly right-of-way line of Boeckman Road (Assessor’s Map 3 1W 13B);
- 204. Thence along said southerly right-of-way line, Easterly 1643 feet, more or less, to the Point of Beginning.

Parcel 5:

Beginning at the westerly southwest corner of Parcel 1 of Partition Plat Number 2009-072 (Assessor’s Map 3 1W 13CD);

- 210. Thence along the southwesterly, westerly and southerly lines of said Parcel, Southeasterly 475 feet, more or less, to the westerly line of Parcel 2 of said Partition Plat (Assessor’s Map 3 1W 13CD);
- 211. Thence along said westerly line, South 155 feet, more or less, to the northerly line of Wilsonville Road (Assessor’s Map 3 1W 13CD);
- 212. Thence along said northerly right-of-way line, Westerly 612 feet, more or less, to the easterly line of Town Center Loop Road East (Assessor’s Map 3 1W 13CD);
- 213. Thence along said easterly right-of-way line, Northerly 528 feet, more or less, to the Point of Beginning.

The above described tract of land contains 455 acres, more or less.

08/15/2018



Michael S. Kalina

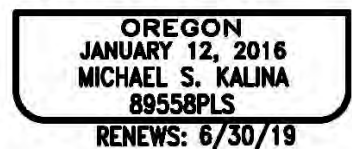
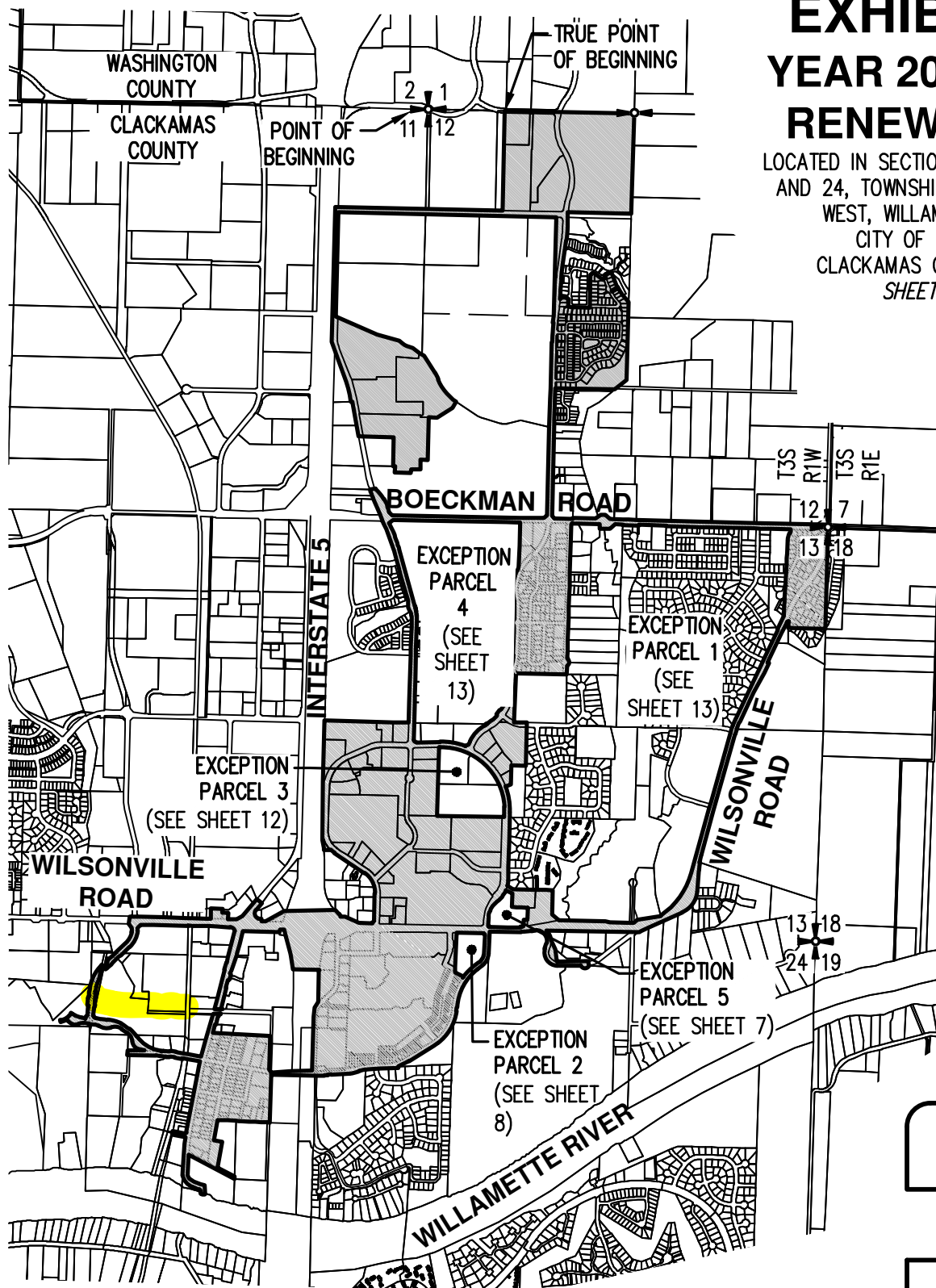

EXHIBIT MAP YEAR 2000 URBAN RENEWAL AREA

LOCATED IN SECTIONS 11, 12, 13, 14, 23,
AND 24, TOWNSHIP 3 SOUTH, RANGE 1
WEST, WILLAMETTE MERIDIAN,
CITY OF WILSONVILLE,
CLACKAMAS COUNTY, OREGON
SHEET 1 OF 14



8/16/2018

REGISTERED
PROFESSIONAL
LAND SURVEYOR

Michael S. Kalina

OREGON
JANUARY 12, 2016
MICHAEL S. KALINA
89558PLS

RENEWS: 6/30/19

LEGEND

- DN. DOCUMENT NUMBER
 - PP NO. PARTITION PLAT NUMBER
 - P. PARCEL NUMBER
 -  URBAN RENEWAL AREA
- SCALE 1" = 2000 FEET



AREA = 455 ACRES±

CITY OF WILSONVILLE
URBAN RENEWAL DISTRICTS

AKS ENGINEERING & FORESTRY, LLC
12965 SW HERMAN RD, STE 100
TUALATIN, OR 97062
P: 503.563.6151 F: 503.563.6152 aks-eng.com



EXHIBIT
B

DRWN: MSK
CHKD: NSW
AKS JOB:
4658

EXHIBIT MAP

YEAR 2000 URBAN RENEWAL AREA

LOCATED IN SECTIONS 11, 12, 13, 14, 23, AND 24,
TOWNSHIP 3 SOUTH, RANGE 1 WEST, WILLAMETTE MERIDIAN,
CITY OF WILSONVILLE, CLACKAMAS COUNTY, OREGON
SHEET 2 OF 14

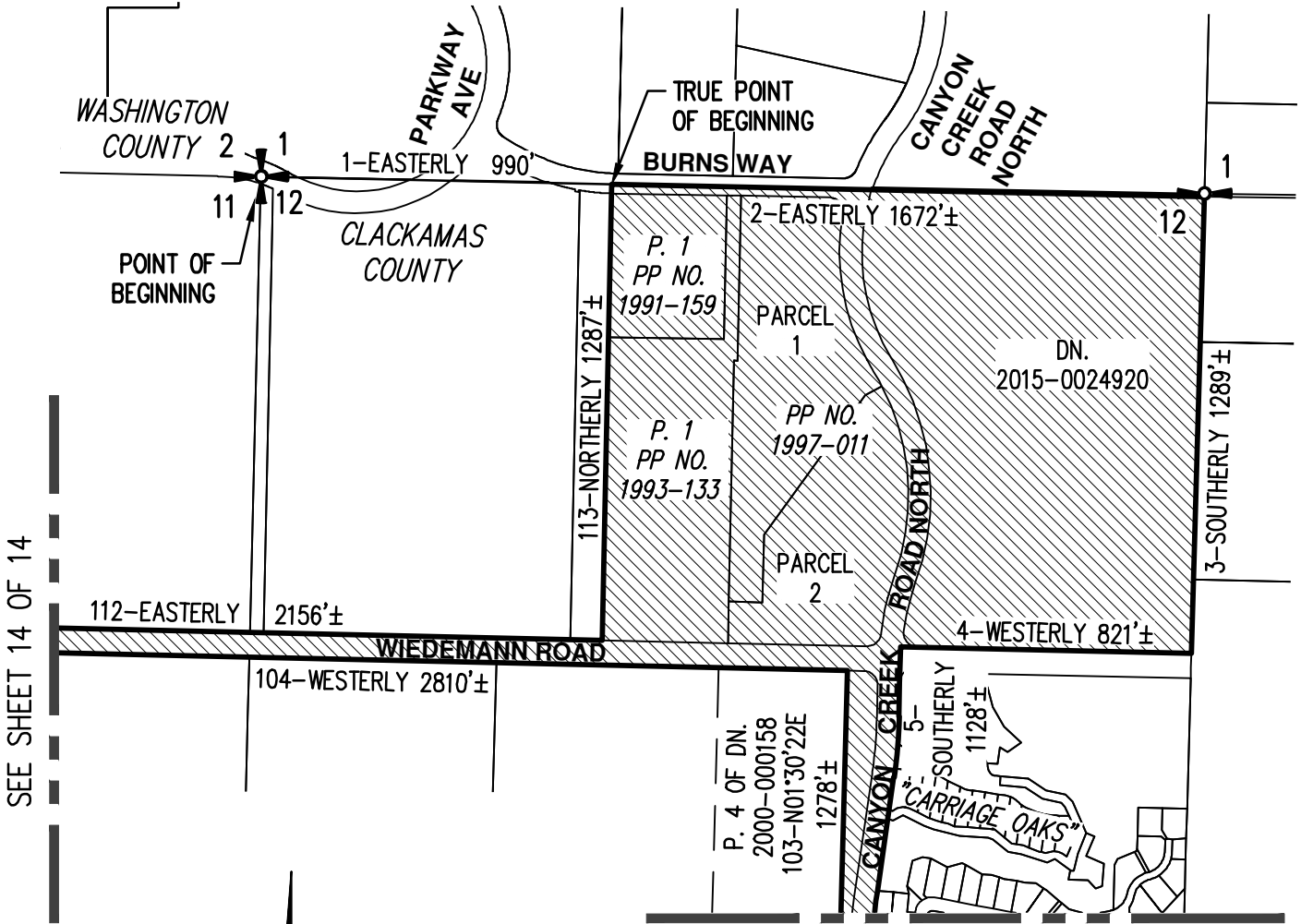

SEE SHEET 14 OF 14

SEE SHEET 3 OF 14

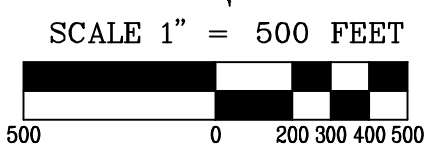

8/16/2018

**REGISTERED
PROFESSIONAL
LAND SURVEYOR**

Michael S. Kalina

OREGON
JANUARY 12, 2016
MICHAEL S. KALINA
89558PLS

RENEWS: 6/30/19

<p>CITY OF WILSONVILLE URBAN RENEWAL DISTRICTS</p> <p>AKS ENGINEERING & FORESTRY, LLC 12965 SW HERMAN RD, STE 100 TUALATIN, OR 97062 P: 503.563.6151 F: 503.563.6152 aks-eng.com</p>	<p>EXHIBIT B</p> <p>DRWN: MSK CHKD: NSW AKS JOB: 4658</p>
---	--

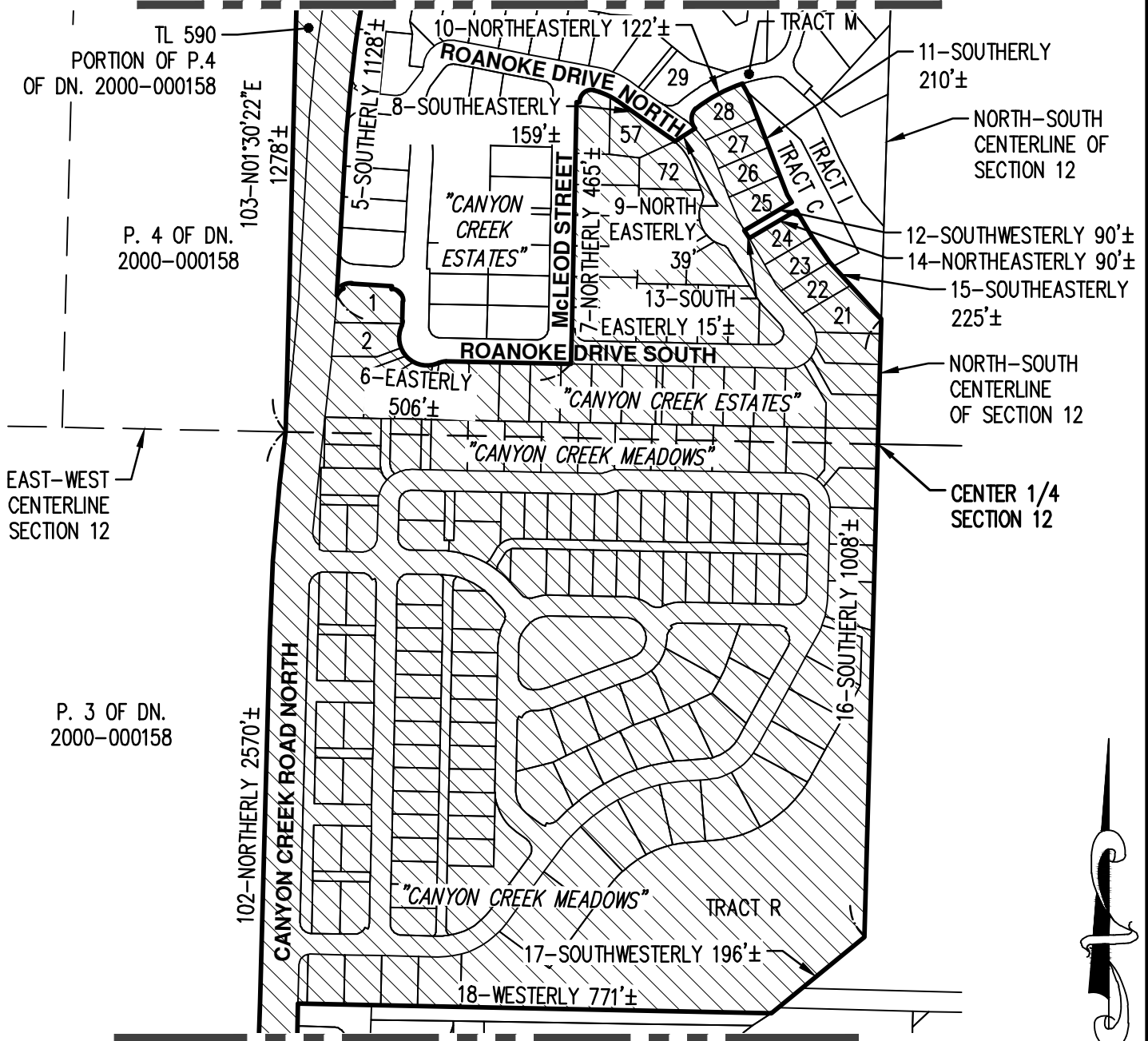

EXHIBIT MAP

YEAR 2000 URBAN RENEWAL AREA

LOCATED IN SECTIONS 11, 12, 13, 14, 23, AND 24, TOWNSHIP 3 SOUTH, RANGE 1 WEST, WILLAMETTE MERIDIAN, CITY OF WILSONVILLE, CLACKAMAS COUNTY, OREGON
SHEET 3 OF 14

MATCH LINE - SEE SHEET 2 OF 14



TL 590
PORTION OF P.4
OF DN. 2000-000158

P. 4 OF DN.
2000-000158

EAST-WEST
CENTERLINE
SECTION 12

P. 3 OF DN.
2000-000158

102-NORTHERLY 2570'±
CANYON CREEK ROAD NORTH

MATCH LINE - SEE SHEET 4 OF 14

8/16/2018

REGISTERED
PROFESSIONAL
LAND SURVEYOR

Michael S. Kalina

OREGON
JANUARY 12, 2016
MICHAEL S. KALINA
89558PLS

RENEWS: 6/30/19

SCALE 1" = 250 FEET



CITY OF WILSONVILLE
URBAN RENEWAL DISTRICTS

AKS ENGINEERING & FORESTRY, LLC
12965 SW HERMAN RD, STE 100
TUALATIN, OR 97062
P: 503.563.6151 F: 503.563.6152 aks-eng.com

AKS

EXHIBIT
B

DRWN: MSK
CHKD: NSW

AKS JOB:
4658

EXHIBIT MAP

YEAR 2000 URBAN RENEWAL AREA

LOCATED IN SECTIONS 11, 12, 13, 14, 23, AND 24, TOWNSHIP 3 SOUTH, RANGE 1 WEST, WILLAMETTE MERIDIAN, CITY OF WILSONVILLE, CLACKAMAS COUNTY, OREGON
SHEET 4 OF 14

SEE SHEET 3 OF 14

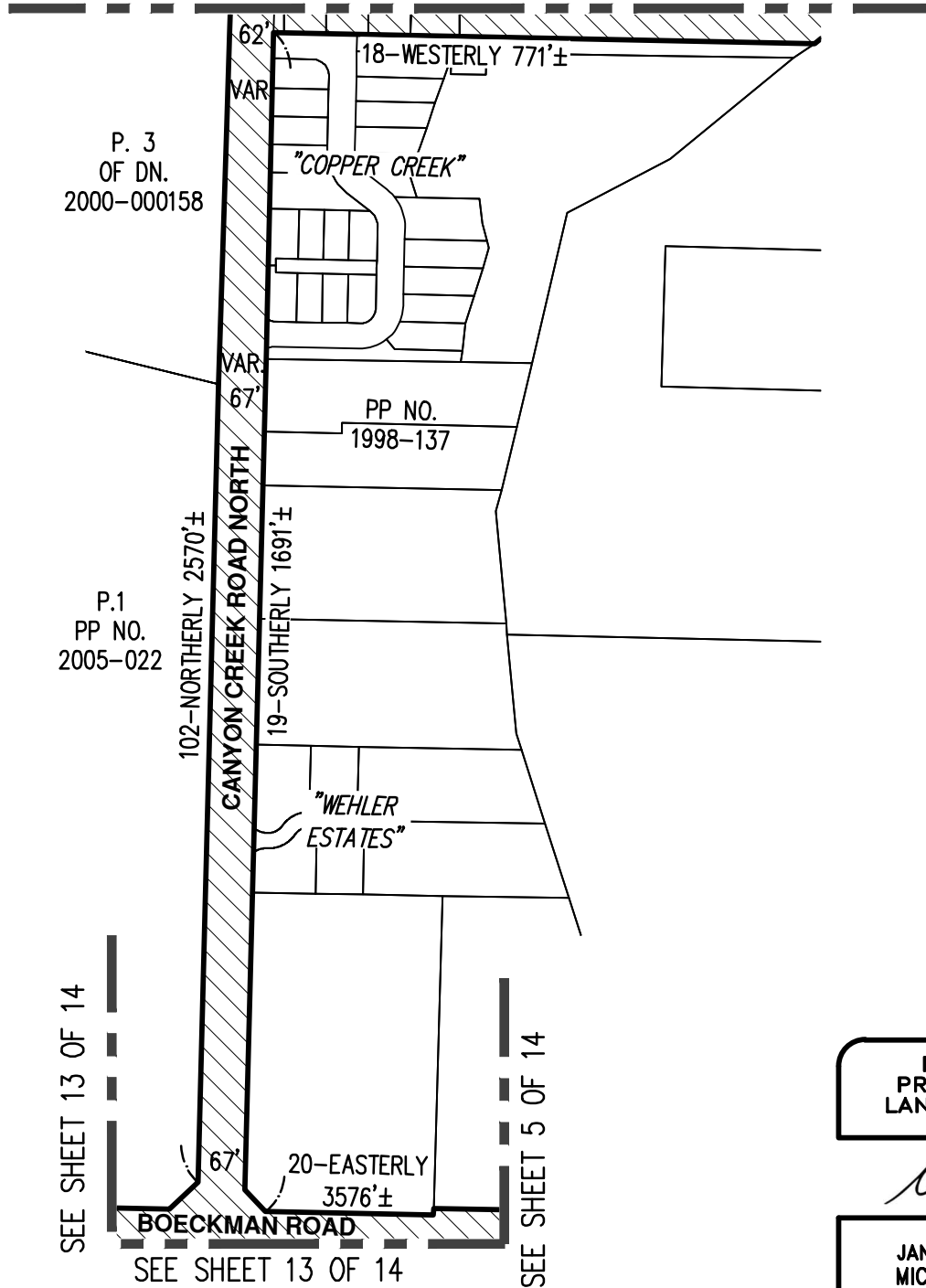

8/16/2018

REGISTERED
PROFESSIONAL
LAND SURVEYOR

Michael S. Kalina

OREGON
JANUARY 12, 2016
MICHAEL S. KALINA
89558PLS

RENEWS: 6/30/19

SCALE 1" = 250 FEET



CITY OF WILSONVILLE
URBAN RENEWAL DISTRICTS

AKS ENGINEERING & FORESTRY, LLC
12965 SW HERMAN RD, STE 100
TUALATIN, OR 97062
P: 503.563.6151 F: 503.563.6152 aks-eng.com



EXHIBIT
B

DRWN: MSK
CHKD: NSW

AKS JOB:
4658

EXHIBIT MAP

YEAR 2000 URBAN RENEWAL AREA

LOCATED IN SECTIONS 11, 12, 13, 14, 23, AND 24, TOWNSHIP 3 SOUTH, RANGE 1 WEST, WILLAMETTE MERIDIAN, CITY OF WILSONVILLE, CLACKAMAS COUNTY, OREGON

SHEET 5 OF 14

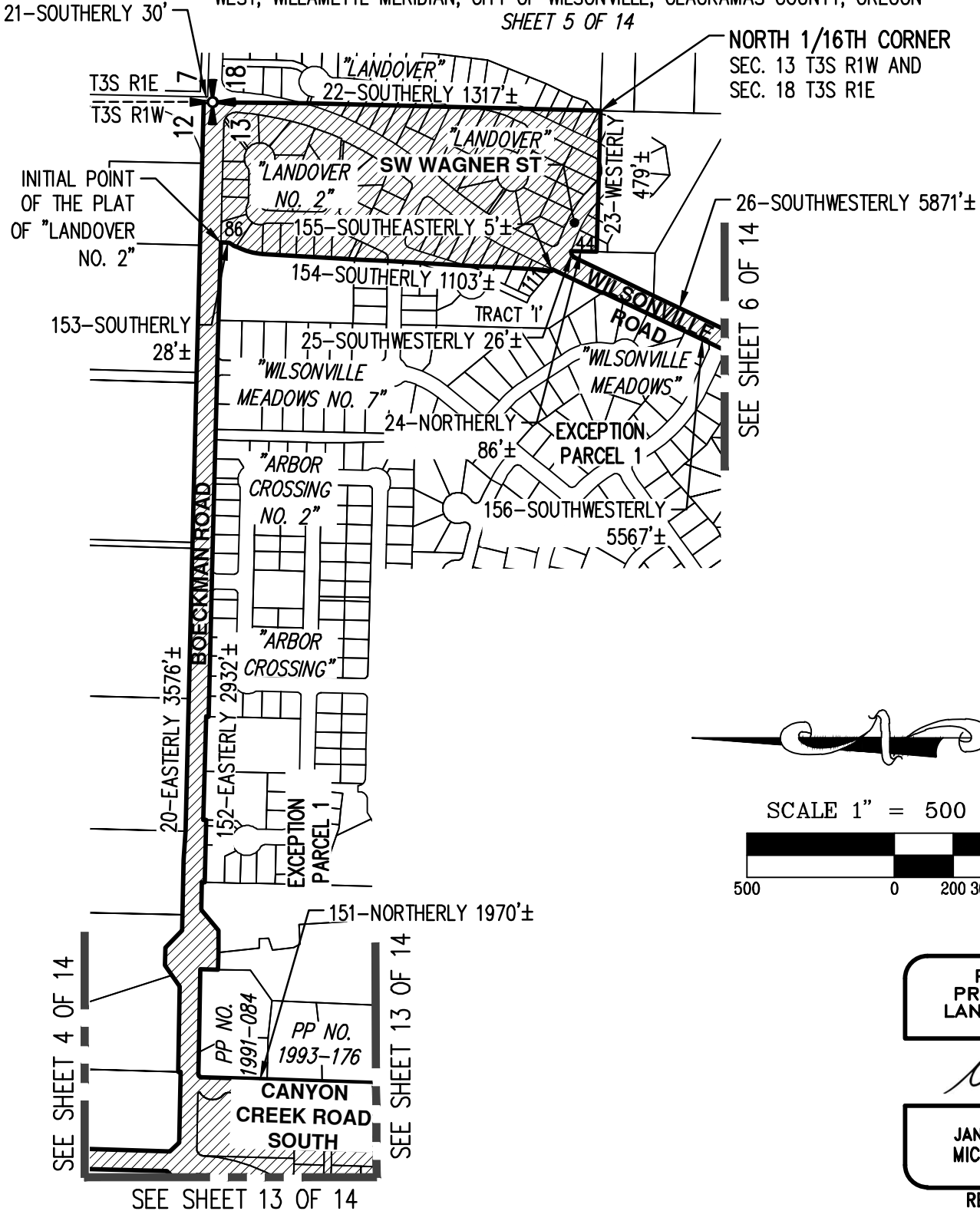

8/16/2018

REGISTERED
PROFESSIONAL
LAND SURVEYOR

Michael S. Kalina

OREGON
JANUARY 12, 2016
MICHAEL S. KALINA
89558PLS

RENEWS: 6/30/19

CITY OF WILSONVILLE
URBAN RENEWAL DISTRICTS

AKS ENGINEERING & FORESTRY, LLC
12965 SW HERMAN RD, STE 100
TUALATIN, OR 97062
P: 503.563.6151 F: 503.563.6152 aks-eng.com



EXHIBIT
B

DRWN: MSK
CHKD: NSW
AKS JOB:
4658

EXHIBIT MAP

YEAR 2000 URBAN RENEWAL AREA

LOCATED IN SECTIONS 11, 12, 13, 14, 23, AND 24, TOWNSHIP 3 SOUTH, RANGE 1 WEST, WILLAMETTE MERIDIAN, CITY OF WILSONVILLE, CLACKAMAS COUNTY, OREGON
SHEET 7 OF 14

SEE SHEET 13 OF 14

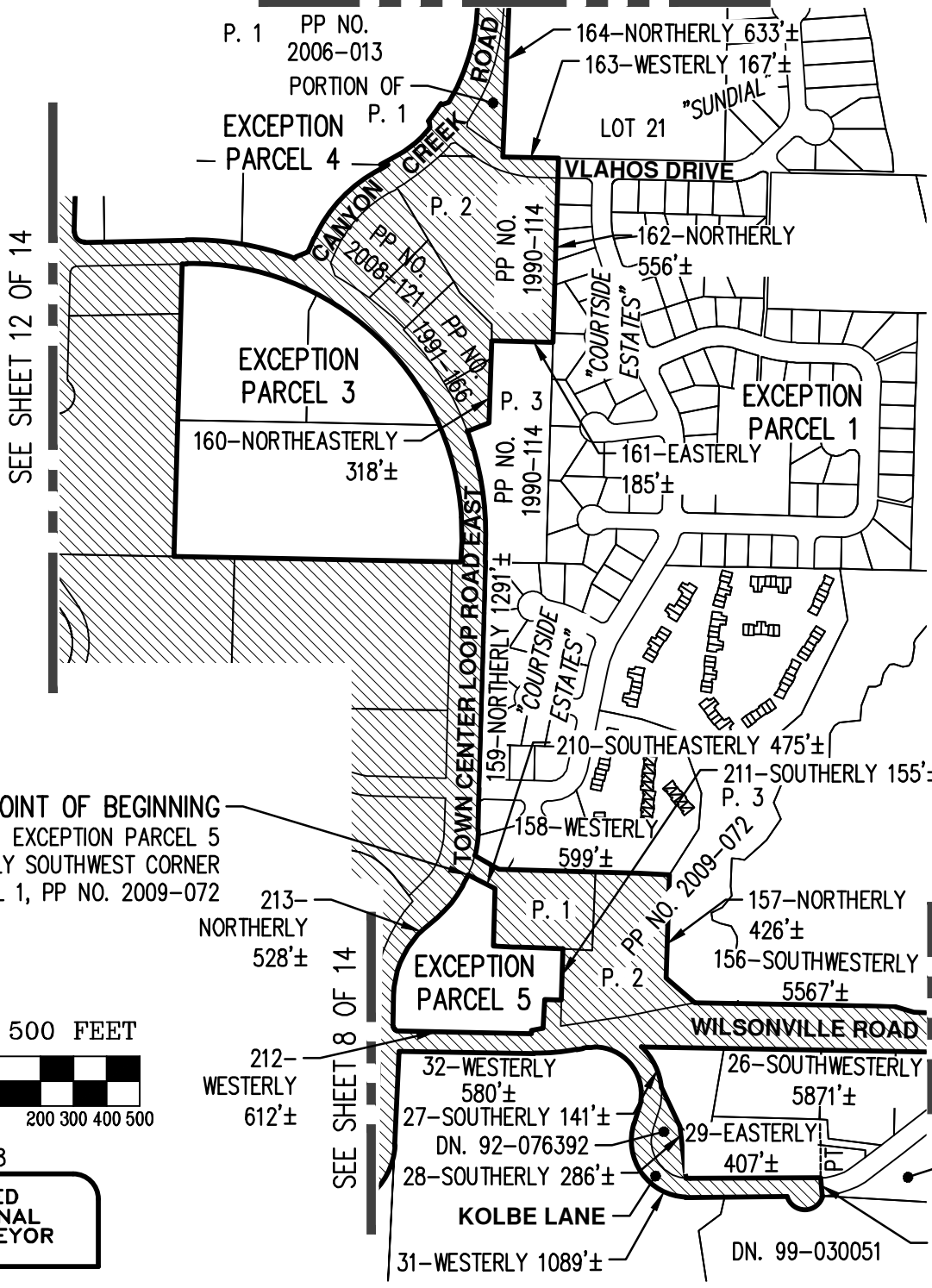

SEE SHEET 12 OF 14

POINT OF BEGINNING
EXCEPTION PARCEL 5
WESTERLY SOUTHWEST CORNER
PARCEL 1, PP NO. 2009-072

SCALE 1" = 500 FEET



8/16/2018

REGISTERED
PROFESSIONAL
LAND SURVEYOR

Michael S. Kalina

OREGON
JANUARY 12, 2016
MICHAEL S. KALINA
89558PLS
RENEWS: 6/30/19

SEE SHEET 8 OF 14

SEE SHEET 6 OF 14

CITY OF WILSONVILLE URBAN RENEWAL DISTRICTS		EXHIBIT B
AKS ENGINEERING & FORESTRY, LLC 12965 SW HERMAN RD, STE 100 TUALATIN, OR 97062 P: 503.563.6151 F: 503.563.6152 aks-eng.com		DRWN: MSK CHKD: NSW AKS JOB: 4658



EXHIBIT MAP

YEAR 2000 URBAN RENEWAL AREA

LOCATED IN SECTIONS 11, 12, 13, 14, 23, AND 24, TOWNSHIP 3 SOUTH, RANGE 1 WEST, WILLAMETTE MERIDIAN, CITY OF WILSONVILLE, CLACKAMAS COUNTY, OREGON
SHEET 8 OF 14

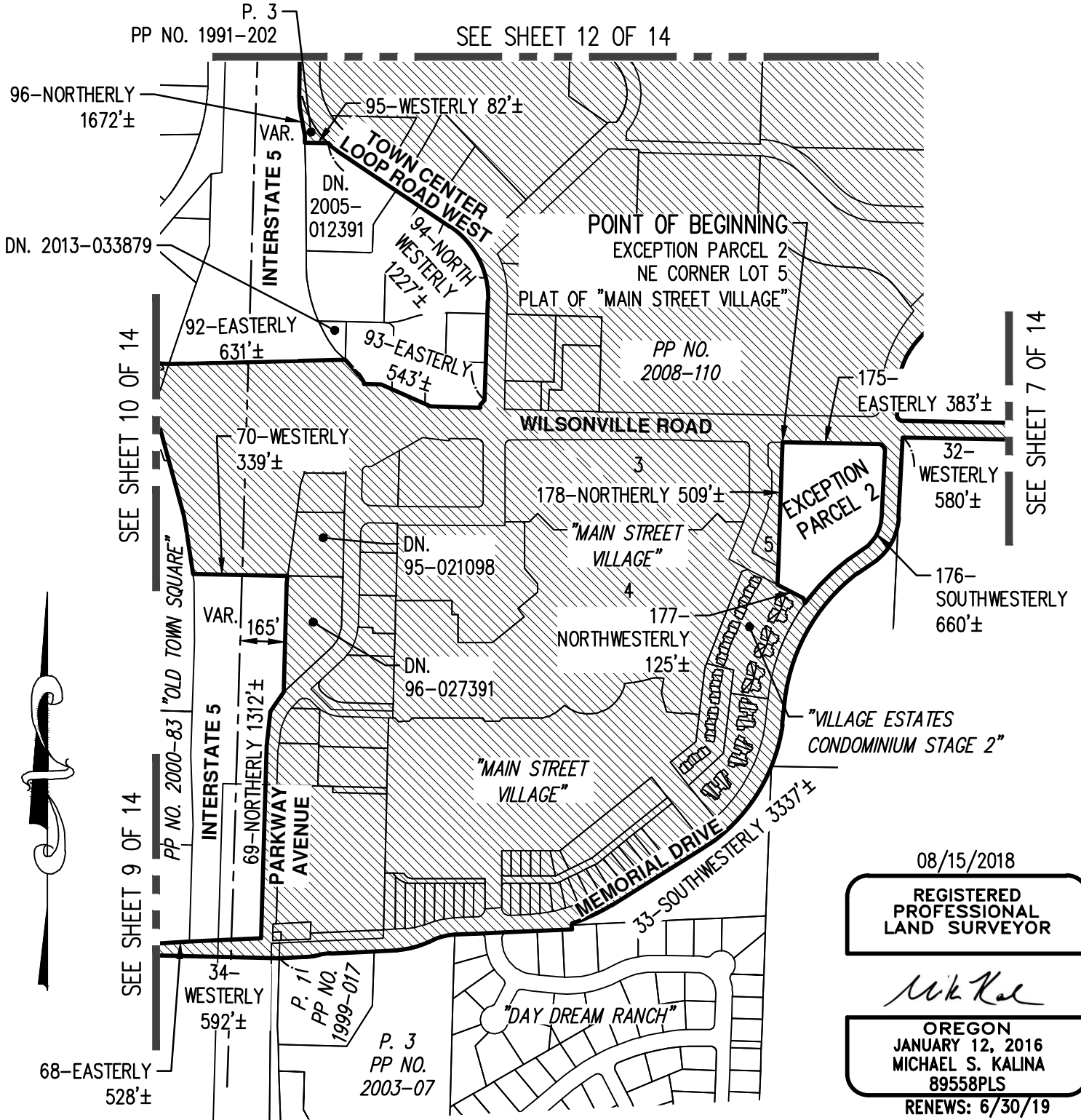

08/15/2018

REGISTERED
PROFESSIONAL
LAND SURVEYOR

Michael S. Kalina

OREGON
JANUARY 12, 2016
MICHAEL S. KALINA
89558PLS

RENEWS: 6/30/19

SCALE 1" = 500 FEET



CITY OF WILSONVILLE
URBAN RENEWAL DISTRICTS

AKS ENGINEERING & FORESTRY, LLC
12965 SW HERMAN RD, STE 100
TUALATIN, OR 97062
P: 503.563.6151 F: 503.563.6152 aks-eng.com

AKS

EXHIBIT
B

DRWN: MSK
CHKD: NSW
AKS JOB:
4658

EXHIBIT MAP

YEAR 2000 URBAN RENEWAL AREA

LOCATED IN SECTIONS 11, 12, 13, 14, 23, AND 24, TOWNSHIP 3 SOUTH, RANGE 1 WEST, WILLAMETTE MERIDIAN, CITY OF WILSONVILLE, CLACKAMAS COUNTY, OREGON
SHEET 9 OF 14

LINE TABLE	
LINE	DIRECTION AND LENGTH
38-L1	EASTERLY 110'±
39-L2	SOUTHERLY 333'±
40-L3	SOUTHEASTERLY 245'±
41-L4	SOUTHERLY 33'±
67-L5	SOUTHEASTERLY 43'±

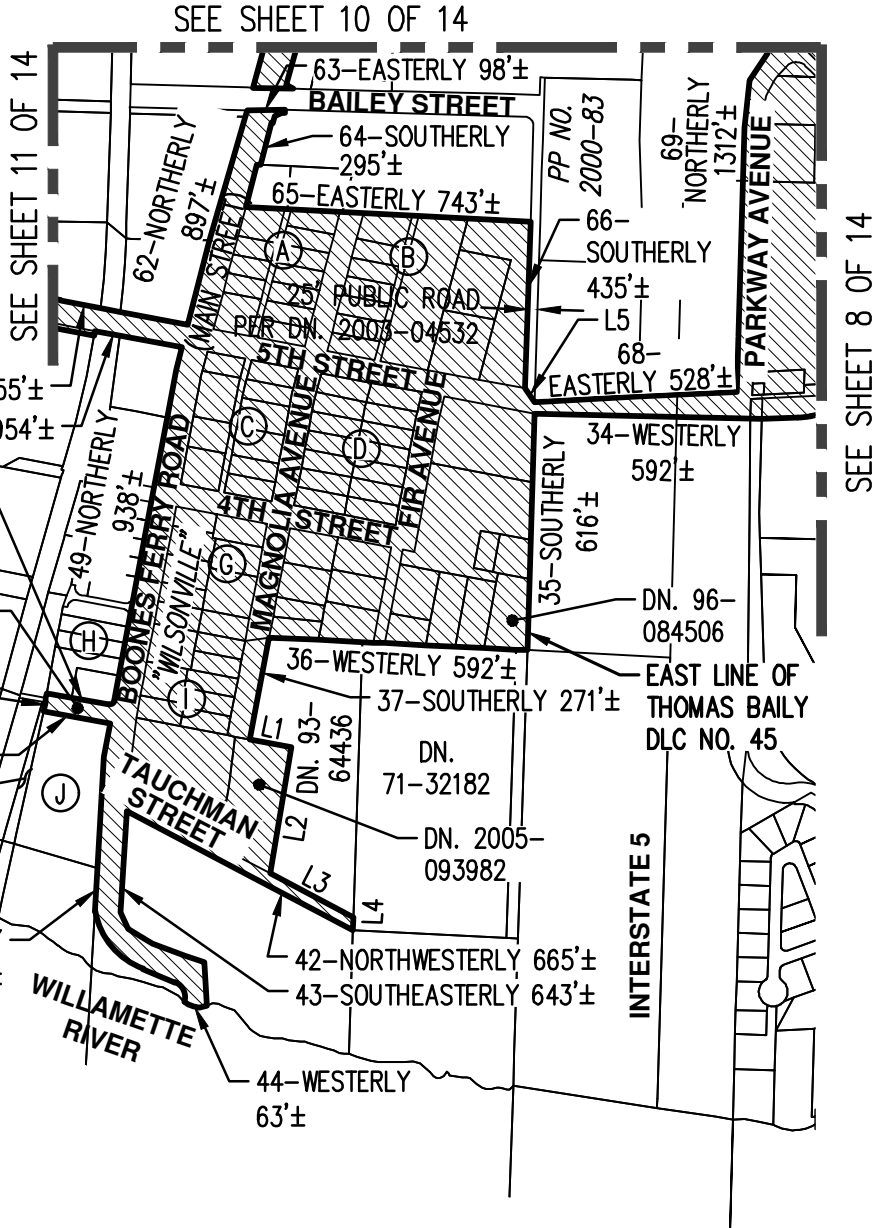

SCALE 1" = 500 FEET



08/15/2018

REGISTERED
PROFESSIONAL
LAND SURVEYOR

Michael S. Kalina

OREGON
JANUARY 12, 2016
MICHAEL S. KALINA
89558PLS
RENEWS: 6/30/19

CITY OF WILSONVILLE
URBAN RENEWAL DISTRICTS

AKS ENGINEERING & FORESTRY, LLC
12965 SW HERMAN RD, STE 100
TUALATIN, OR 97062
P: 503.563.6151 F: 503.563.6152 aks-eng.com



EXHIBIT
B

DRWN: MSK
CHKD: NSW
AKS JOB:
4658

EXHIBIT MAP

YEAR 2000 URBAN RENEWAL AREA

LOCATED IN SECTIONS 11, 12, 13, 14, 23, AND 24, TOWNSHIP 3 SOUTH, RANGE 1 WEST, WILLAMETTE MERIDIAN, CITY OF WILSONVILLE, CLACKAMAS COUNTY, OREGON
SHEET 10 OF 14

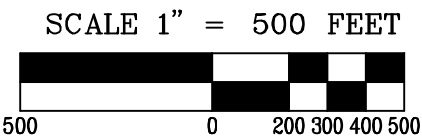
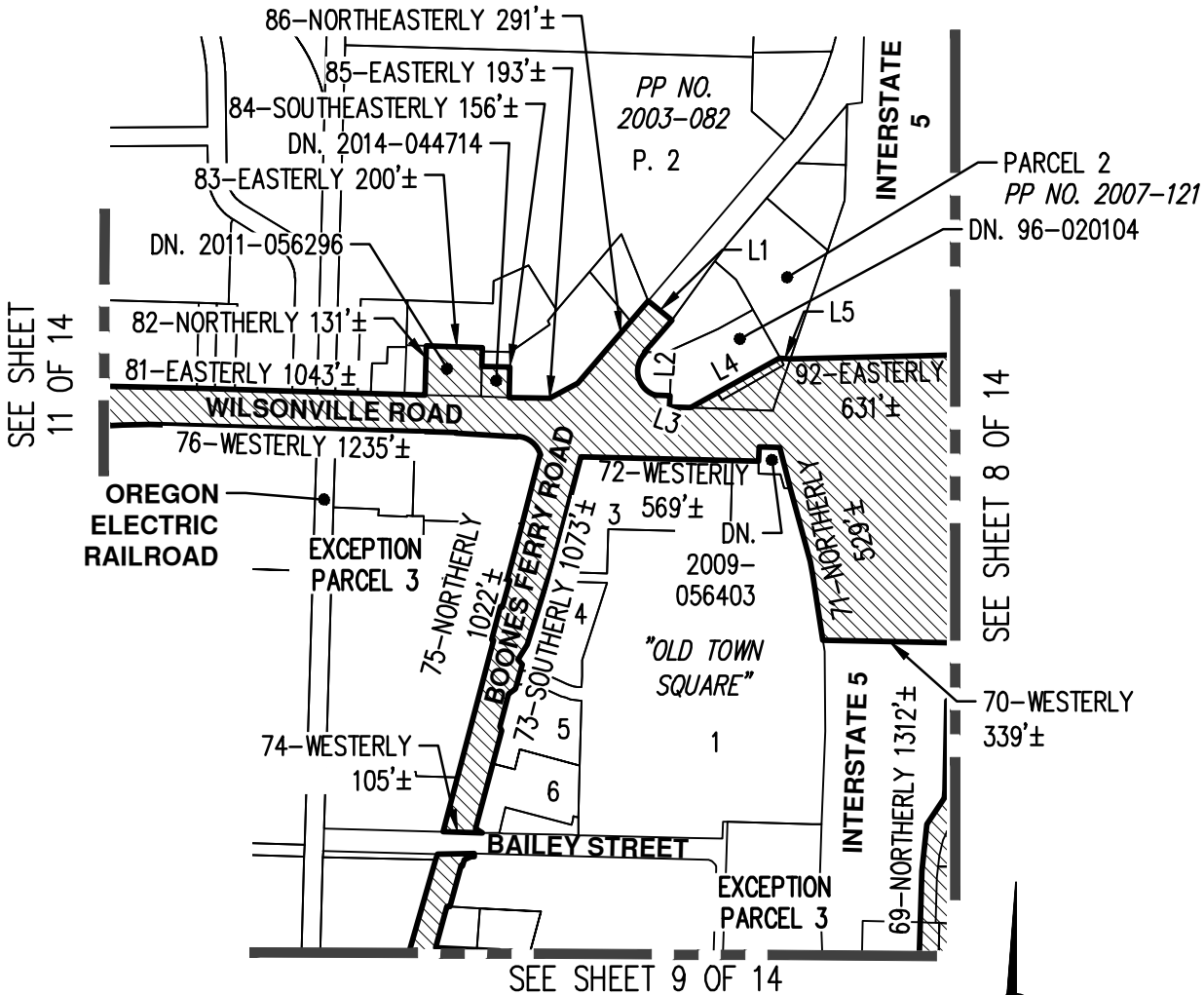

LINE TABLE	
LINE	DIRECTION AND LENGTH
87-L1	SOUTHEASTERLY 82'±
88-L2	SOUTHERLY 259'±
89-L3	EASTERLY 125'±
90-L4	NORTHEASTERLY 274'±
91-L5	EASTERLY 28'±

08/15/2018

REGISTERED
PROFESSIONAL
LAND SURVEYOR

Michael S. Kalina

OREGON
JANUARY 12, 2016
MICHAEL S. KALINA
89558PLS

RENEWS: 6/30/19

CITY OF WILSONVILLE
URBAN RENEWAL DISTRICTS

AKS ENGINEERING & FORESTRY, LLC
12965 SW HERMAN RD, STE 100
TUALATIN, OR 97062
P: 503.563.6151 F: 503.563.6152 aks-eng.com

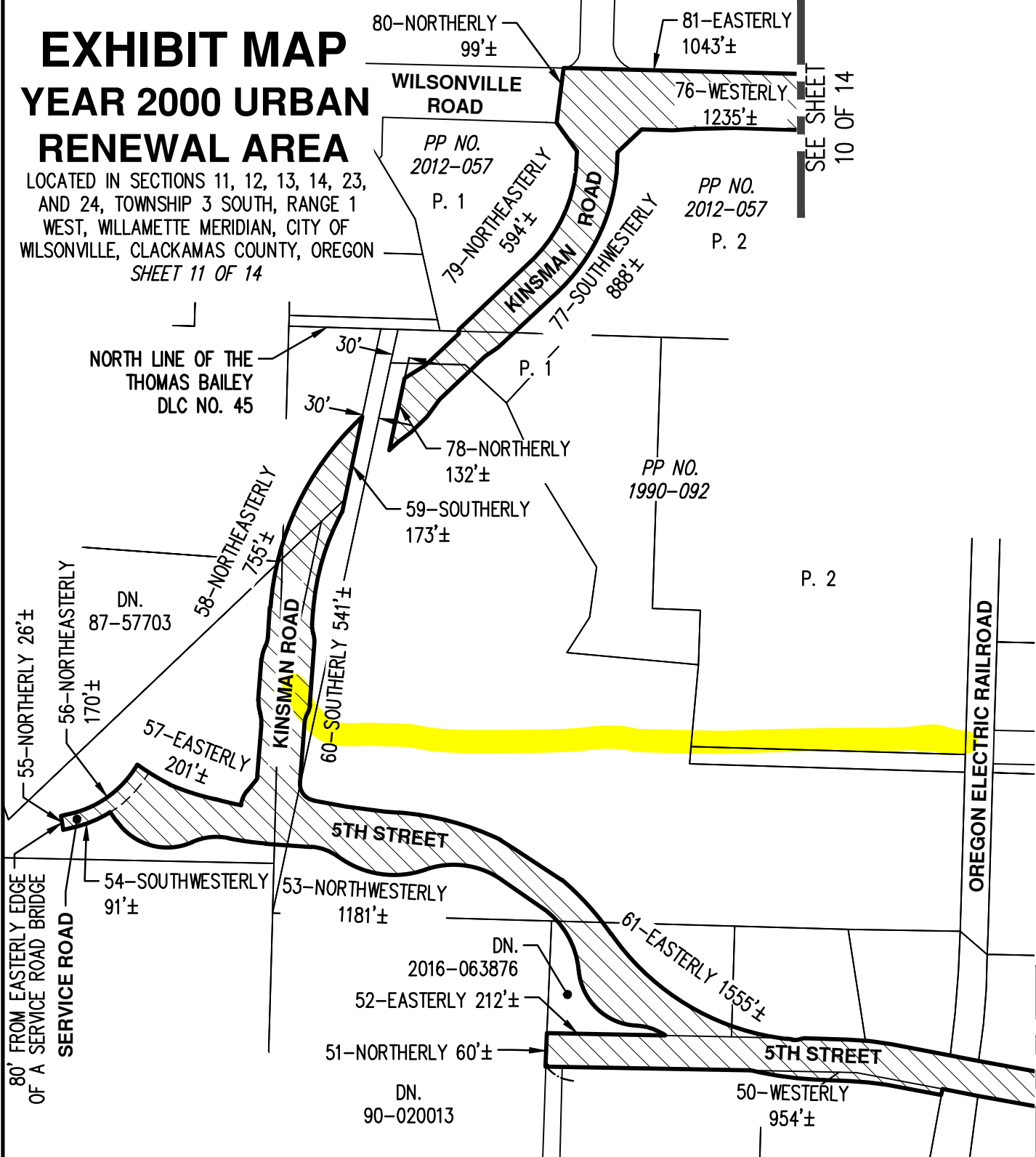

EXHIBIT
B

DRWN: MSK
CHKD: NSW
AKS JOB:
4658

EXHIBIT MAP YEAR 2000 URBAN RENEWAL AREA

LOCATED IN SECTIONS 11, 12, 13, 14, 23,
AND 24, TOWNSHIP 3 SOUTH, RANGE 1
WEST, WILLAMETTE MERIDIAN, CITY OF
WILSONVILLE, CLACKAMAS COUNTY, OREGON
SHEET 11 OF 14



SEE SHEET
10 OF 14



SEE SHEET 9 OF 14

08/15/2018

REGISTERED
PROFESSIONAL
LAND SURVEYOR

M. Kalina

OREGON
JANUARY 12, 2016
MICHAEL S. KALINA
89558PLS

RENEWS: 6/30/19

SCALE 1" = 250 FEET



CITY OF WILSONVILLE
URBAN RENEWAL DISTRICTS

AKS ENGINEERING & FORESTRY, LLC
12965 SW HERMAN RD, STE 100
TUALATIN, OR 97062
P: 503.563.6151 F: 503.563.6152 aks-eng.com



EXHIBIT
B

DRWN: MSK
CHKD: NSW

AKS JOB:
4658

EXHIBIT MAP

YEAR 2000 URBAN RENEWAL AREA

LOCATED IN SECTIONS 11, 12, 13, 14, 23, AND 24, TOWNSHIP 3 SOUTH, RANGE 1 WEST, WILLAMETTE MERIDIAN, CITY OF WILSONVILLE, CLACKAMAS COUNTY, OREGON
SHEET 12 OF 14

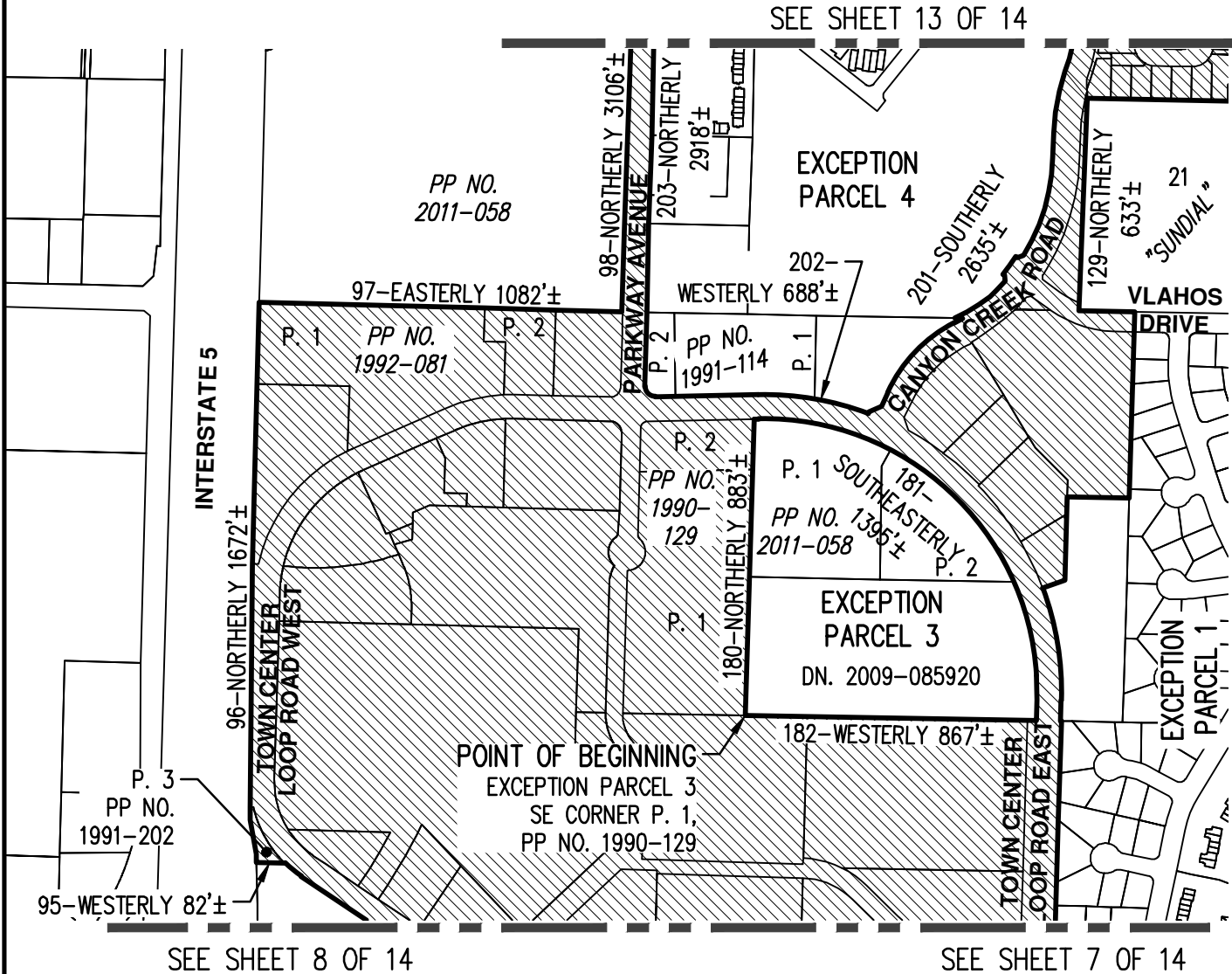

08/15/2018

REGISTERED
PROFESSIONAL
LAND SURVEYOR

M. Kal

OREGON
JANUARY 12, 2016
MICHAEL S. KALINA
89558PLS

RENEWS: 6/30/19

SCALE 1" = 500 FEET



500 0 200 300 400 500

CITY OF WILSONVILLE
URBAN RENEWAL DISTRICTS

AKS ENGINEERING & FORESTRY, LLC
12965 SW HERMAN RD, STE 100
TUALATIN, OR 97062

P: 503.563.6151 F: 503.563.6152 aks-eng.com

AKS

EXHIBIT
B

DRWN: MSK
CHKD: NSW

AKS JOB:
4658

EXHIBIT MAP

YEAR 2000 URBAN RENEWAL AREA

LOCATED IN SECTIONS 11, 12, 13, 14, 23, AND 24, TOWNSHIP 3 SOUTH, RANGE 1 WEST, WILLAMETTE MERIDIAN, CITY OF WILSONVILLE, CLACKAMAS COUNTY, OREGON
SHEET 13 OF 14

SEE SHEET 4 OF 14

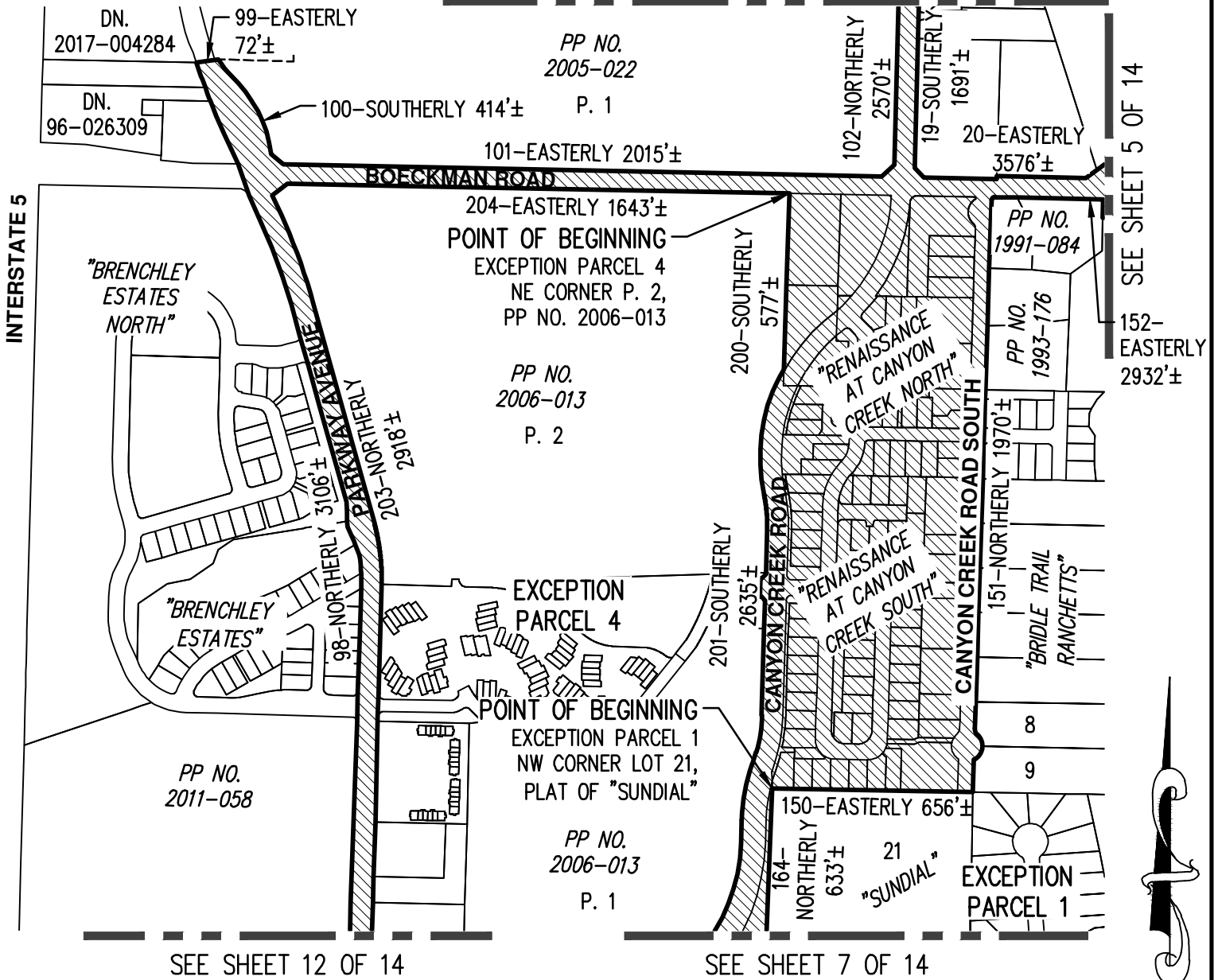

08/15/2018

REGISTERED
PROFESSIONAL
LAND SURVEYOR

Mike Kal

OREGON
JANUARY 12, 2016
MICHAEL S. KALINA
89558PLS

RENEWS: 6/30/19

SCALE 1" = 500 FEET



500 0 200 300 400 500

CITY OF WILSONVILLE
URBAN RENEWAL DISTRICTS

AKS ENGINEERING & FORESTRY, LLC
12965 SW HERMAN RD, STE 100
TUALATIN, OR 97062
P: 503.563.6151 F: 503.563.6152 aks-eng.com

AKS

EXHIBIT
B

DRWN: MSK
CHKD: NSW
AKS JOB:
4658

EXHIBIT MAP

YEAR 2000 URBAN RENEWAL AREA

LOCATED IN SECTIONS 11, 12, 13, 14, 23, AND 24,
TOWNSHIP 3 SOUTH, RANGE 1 WEST, WILLAMETTE MERIDIAN,
CITY OF WILSONVILLE, CLACKAMAS COUNTY, OREGON
SHEET 14 OF 14

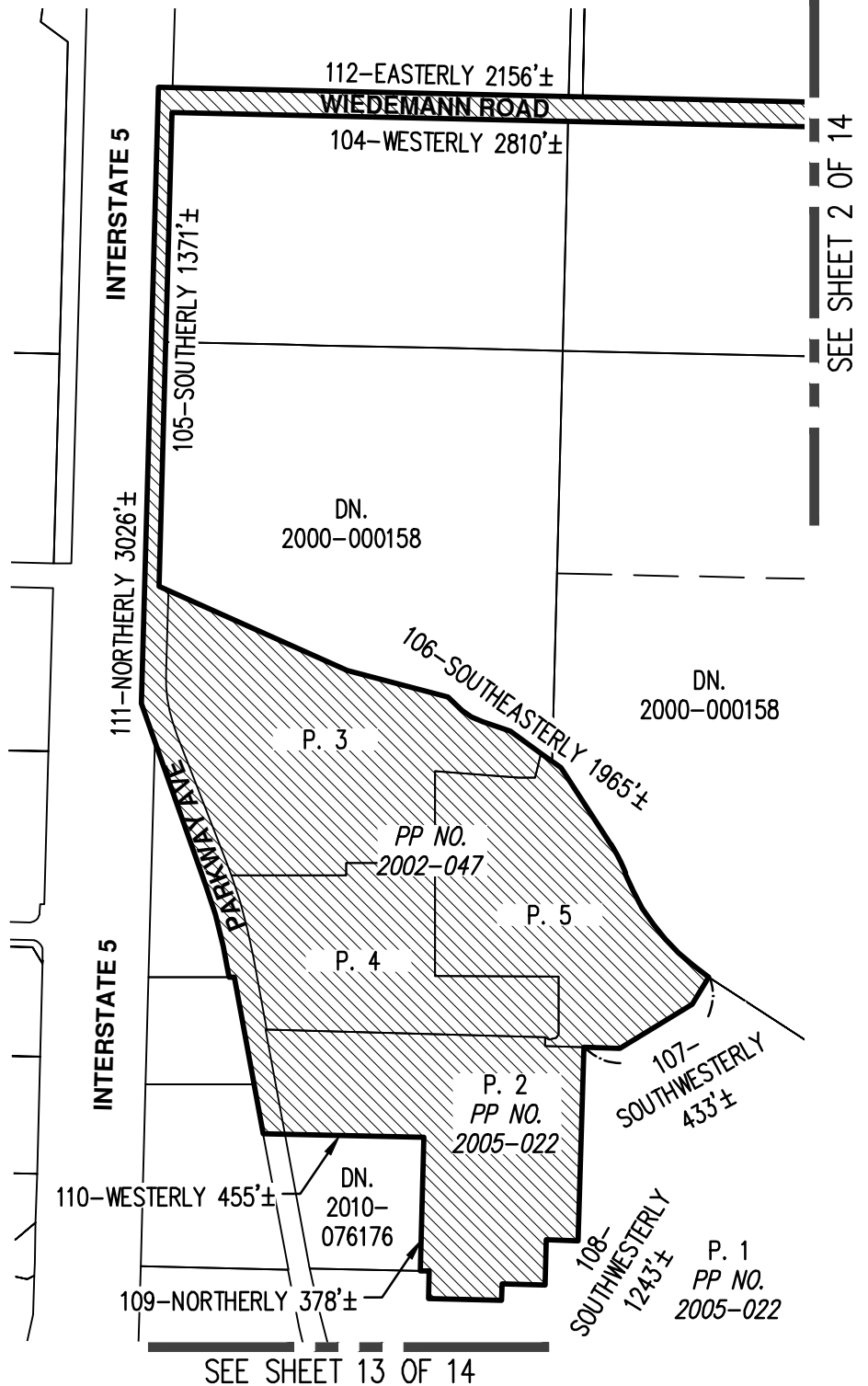
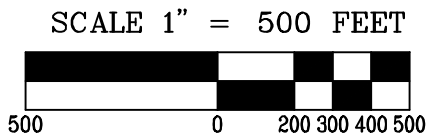

08/15/2018

REGISTERED
PROFESSIONAL
LAND SURVEYOR

M. S. Kalina

OREGON
JANUARY 12, 2016
MICHAEL S. KALINA
89558PLS

RENEWS: 6/30/19

CITY OF WILSONVILLE
URBAN RENEWAL DISTRICTS

AKS ENGINEERING & FORESTRY, LLC
12965 SW HERMAN RD, STE 100
TUALATIN, OR 97062
P: 503.563.6151 F: 503.563.6152 aks-eng.com



EXHIBIT
B

DRWN: MSK
CHKD: NSW
AKS JOB:
4658

Report Accompanying the Year 2000 Urban Renewal Plan 12th Amendment – A Minor Amendment

This amendment is a Minor Amendment per Section 1200 of the Y2000 Urban Renewal Plan. Since this is not a substantial amendment, a full Report accompanying the Plan amendment is not required. However, to aid in understanding the additions, a partial report is included with this amendment.

I. Existing Physical, Social and Economic Conditions

The limited acreage to be added is approximately 1 acre of partially-developed land. The boundary change clarifies the designed alignment for the 5th Street/ Kinsman Road Extension, the first phase of the Old Town Escape project and corrects the previous boundary that provided only an estimated alignment. There is limited public infrastructure serving the parcels and limited urban development on the parcels. The county assessor will determine the assessed value of the parcels upon adoption of the amendment and transmission to the assessor's office. The new boundary is provided in the Year 2000 Urban Renewal Plan 12th Amendment - Exhibit A.

The focus area for the boundary change is shown in Figure 1. This boundary includes two potential routes for the new east-west connector that parallels Wilsonville Road to the south (between Old Town (Boones Ferry Road) and Kinsman which then connects to Wilsonville Road). A final location for the connector had not been determined - two potential routes included a Bailey Street extension and a 5th Street extension to the west.

Figure 1 – Boundary Change Area – Before 12th Amendment

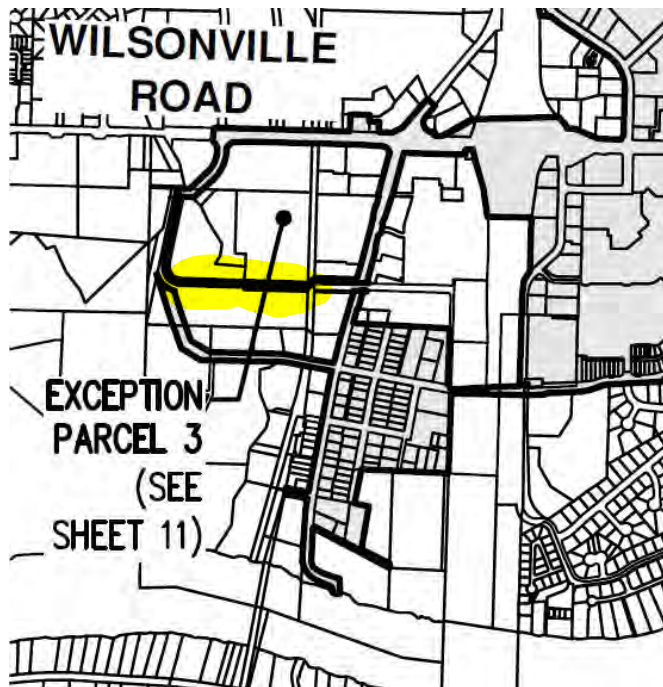

The 10th Amendment to the Year 2000 Plan boundary change clarifies the location of the new east-west connector based on the City Council decision that it be a 5th Street extension (see Figure 2 below). The new boundary description (see Year 2000 Urban Renewal Plan 12th Amendment - Exhibit A) incorporates the most recent design for the road and Ice Age Tonquin Trail.

Figure 2 – Boundary Change Area – After 12th Amendment

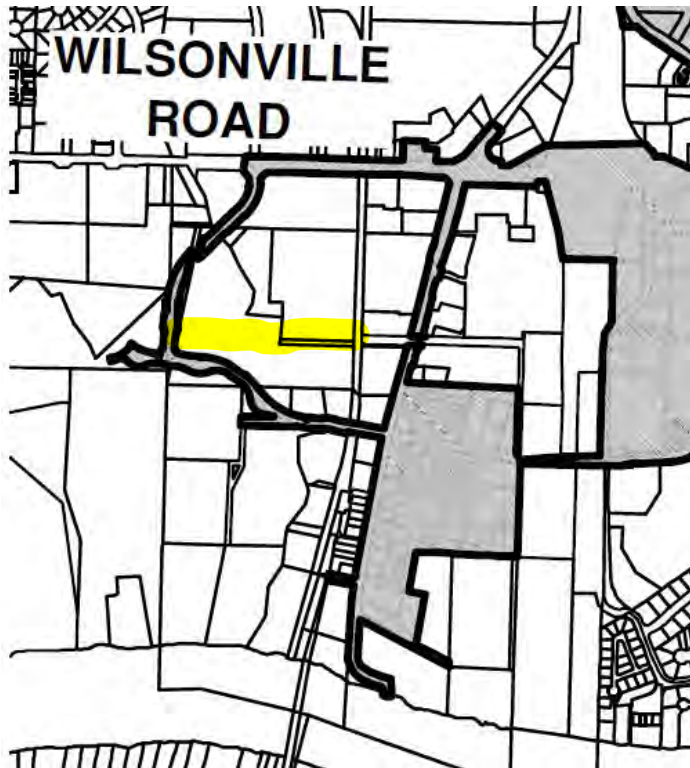

The boundary change results in a 1-acre increase in the overall acreage of the Year 2000 Urban Renewal Area (details presented in Year 2000 Urban Renewal Plan 12th Amendment - Exhibit A).

II. Reasons for Selection of Each Urban Renewal Area

The acreage to be added was selected to correct the previous boundary that was based on potential project alignments. The new acreage is blighted and will allow for the future construction of the 5th Street / Kinsman Road Extension transportation project.

III. The Relationship Between the Urban Renewal Projects and the Existing Conditions in the Urban Renewal Area.

No changes

IV. The Estimated Total Cost of Each Project and the Sources of Money to pay for Such Costs

Based on the 90% design plans, the cost estimate is \$16.6 million for the 5th Street / Kinsman Road Extension (aka Old Town Escape and Old Town Streets). The urban renewal participation is budgeted at \$12,745,551. Other City funds, such as System Development Charges be used to fully fund the project.

V. The Anticipated Completion Date for Each Project

The alignment for the Old Town Escape was adopted by the City of Wilsonville City Council in 2016. The first construction phase of the project is expected to occur between 2018 and 2020.

VI. Financial Analysis

No increased maximum indebtedness is planned. There is sufficient maximum indebtedness capacity to fund the \$12,745,551 budgeted for the 5th Street / Kinsman Road Extension (aka Old Town Escape and Old Town Streets). The project does not change the life of the district beyond the currently anticipated closure in FY 2023/24 and will not impact the Agency’s ability to continue to under-levy tax increment revenue in the district.

VII. Impact of the Tax Increment Financing

No changes

VIII. Compliance with Statutory Limits on Assessed Value and Size of Urban Renewal Area

State law limits the percentage of both a municipality’s total assessed value and the total land area that can be contained in an urban renewal area at the time of its establishment to 25% for municipalities under 50,000 in population. The Area complies with both the acreage and assessed value limitations. These estimates are based on changes after both the West Side and Year 2000 Amendments are adopted.

Table 2 - Urban Renewal Area Conformance with Assessed Value and Area Limits

Urban Renewal Area	Frozen Base/AV	Acres
West Side URA	\$16,526,288*	415
Year 2000 URA	\$44,087,806*	455
Coffee Creek URA	\$90,000,000*	258
TIF Zones		
277255 SW 95 th Ave	\$17,938,434	26.07
26440 SW Parkway	\$12,582,201	24.98
26755 SW 95 th Ave	\$7,675,439	9.76
Total in URAs	\$198,743,491	1,189
City of Wilsonville – 06-30-2017	\$3,403,012,022*	4,975
Percent of Total	5.8%	23.9%

Source: City of Wilsonville, Actual Audited FY16-17 Budget for Washington and Clackamas Counties



First American Title Insurance Company

National Commercial Services

200 SW Market Street Suite 250

Portland, OR 97201

(503)795-7600 - Fax (866)678-0591

Title Officer: Steve Manome
(503)219-8742
smanome@firstam.com
(866)678-0591

LOT BOOK SERVICE

Elliott, Ostrander & Preston, PC
707 Sw Washington St, Suite 1500
Portland, OR 97205-3518

Order No.: NCS-1196609-OR1

Attn: Jerry Elliott
Phone No.: (503)224-7112 - Fax No.: (503)224-7818
Email: jerry@eoplaw.com

Re: Inland Empire Investments LLC

We have searched our Tract Indices as to the following described property:

The land referred to in this report is described in Exhibit A attached hereto.

and as of October 16, 2023 at 8:00 a.m.

We find that the last deed of record runs to

[Inland Empire Investments, LLC, an Oregon limited liability company](#)

We also find the following apparent encumbrances prior to the effective date hereof:

1. Easement, including terms and provisions contained therein:
Recording Date: August 19, 1870
Recording Information: [Book H, page 184](#)
In Favor of: Railroad Parkway
For: Railroad
Affects: Parcel I
2. Easement, including terms and provisions contained therein:
Recording Date: August 28, 1941
Recording Information: [Book 284, page 428](#)
In Favor of: United States of America

For: Transmission line and incidental purposes
Affects: Parcel II

3. Easement, including terms and provisions contained therein:
Recording Date: February 14, 1956
Recording Information: [Book 522, page 40](#)
In Favor of: United States of America
For: Transmission line and incidental purposes
Affects: Parcel I

The above document was re-recorded February 21, 1956 in/as [Book 522, page 280](#) of Official Records.

4. Easement, including terms and provisions contained therein:
Recording Date: February 14, 1973
Recording Information: [73004469](#)
In Favor of: The Wickes Corporation, a Delaware corporation
For: Right-of-way
Affects: as described therein.
5. The terms and provisions contained in the document entitled "Access Agreement" recorded February 14, 1973 as Recording No. [73004470](#) of Official Records.
6. Easement, including terms and provisions contained therein:
Recording Date: March 29, 1973
Recording Information: [73009249](#)
In Favor of: The City of Wilsonville
For: Sewer
Affects: as described therein.
7. Easement, including terms and provisions contained therein:
Recording Date: February 16, 1982
Recording Information: [82004556](#)
In Favor of: The City of Wilsonville
For: Drainage
Affects: Parcel I
8. Restrictions, conditions, dedications, notes, easements and provisions, if any, as contained and/or delineated on the face of the Partition Plat No. [1990-92](#) recorded September 27, 1990 as Recording No. [90048424](#), in Clackamas County, Oregon.
9. Easement, including terms and provisions contained therein:
Recording Date: October 18, 1990
Recording Information: [90051985](#)
In Favor of: Inland Empire Investments, an Oregon general partnership
For: Driveway
Affects: as described therein.
10. The terms and provisions contained in the document entitled "Easement for Ingress and Egress Agreement" recorded October 18, 1990 as [90051989](#) of Official Records.

11. The terms and provisions contained in the document entitled "Easement for Sewer and Water Agreement" recorded October 18, 1990 as [90051990](#) of Official Records.

12. Easement, including terms and provisions contained therein:
Recording Date: January 25, 2007
Recording Information: [2007-006606](#)
In Favor of: The City of Wilsonville
For: Sanitary sewer, storm drain or water pipelines and appurtenances
Affects: Parcel II

13. Easement, including terms and provisions contained therein:
Recording Date: January 25, 2007
Recording Information: [2007-006607](#)
In Favor of: The City of Wilsonville
For: Sanitary sewer, storm drain or water pipelines and appurtenances
Affects: Parcel I

14. A Deed of Trust to secure an original indebtedness of \$16,600,000.00 recorded March 13, 2020 as Recording No. [2020-018451](#) of Official Records.
Dated: March 5, 2020
Trustor: [Inland Empire Investments, LLC, an Oregon limited liability company](#)
Trustee: Wells Fargo National Bank West
Beneficiary: Wells Fargo Bank, National Association

The terms and provisions contained in the document entitled "Consent and Subordination" recorded March 8, 2021 as Recording No. [2021-023376](#) of Official Records.

A document recorded March 11, 2021 as Recording No. [2021-025116](#) of Official Records provides that First American Title Insurance Company was substituted as trustee under the deed of trust.

The Deed of Trust/Mortgage was Partially reconveyed as to that portion conveyed for street purposes by instrument recorded March 11, 2021 under Recording No. [2021-025117](#).

A document recorded August 23, 2022 as Recording No. [2022-046735](#), of Official Records provides that the Deed of Trust/Mortgage or the obligation secured thereby has been modified.

15. Terms and provisions of an unrecorded lease dated December 1, 2006, by and between Inland Empire Investments, LLC as lessor and OREPAC Holding Company, an Oregon corporation as lessee, as disclosed by a Memorandum of Lease recorded March 13, 2020 as Recording No. [2020-018452](#) of Official Records.

A document recorded March 13, 2020 as Recording No. [2020-018453](#) of Official Records provides that the above document was subordinated to the document recorded March 13, 2020 as Recording No. [2020-018451](#) of Official Records.

16. Terms and provisions of an unrecorded lease dated December 1, 2006, by and between Inland Empire Investments, LLC as lessor and Oregon Pacific Building Products, Inc. as lessee, as disclosed by a Memorandum of Lease recorded March 13, 2020 as Recording No. [2020-018454](#) of Official Records.

A document recorded March 13, 2020 as Recording No. [2020-018455](#) of Official Records provides that the above document was subordinated to the document recorded March 13, 2020 as Recording No. [2020-018451](#) of Official Records.

- 17. Easement, including terms and provisions contained therein:
 Recording Date: March 8, 2021
 Recording Information: [2021-023348](#)
 In Favor of: The City of Wilsonville
 For: Public utility and slope
 Affects: Parcel I

- 18. Easement, including terms and provisions contained therein:
 Recording Date: March 8, 2021
 Recording Information: [2021-023349](#)
 In Favor of: The City of Wilsonville
 For: Public utility and slope
 Affects: Parcel I

- 19. Unrecorded leases or periodic tenancies, if any.

We have also searched our General Index for Judgments and State and Federal Liens against the Grantee(s) named above and find:

NONE

We also find the following unpaid taxes and city liens:

- 1. Taxes for the year 2023-2024
 Tax Amount: \$23,027.95
 Unpaid Balance: \$23,027.95, plus interest, if any
 Code No.: 003-023
 Map & Tax Lot No.: 31W23B 00700
 Property ID/Key No.: 00818761

 (Affects a portion of Parcel I)

- 2. Taxes for the year 2023-2024
 Tax Amount: \$377.91
 Unpaid Balance: \$377.91, plus interest, if any
 Code No.: 003-023
 Map & Tax Lot No.: 31W23B 00780
 Property ID/Key No.: 05031602

 (Affects a portion of Parcel I)

- 3. Taxes for the year 2023-2024
 Tax Amount: \$145,898.15
 Unpaid Balance: \$145,898.15, plus interest, if any
 Code No.: 003-023
 Map & Tax Lot No.: 31W23B 00701
 Property ID/Key No.: 01449007

(Affects a portion of Parcel II)

4. Taxes for the year 2023-2024
- | | |
|----------------------|-----------------------------------|
| Tax Amount: | \$1,121.24 |
| Unpaid Balance: | \$1,121.24, plus interest, if any |
| Code No.: | 003-023 |
| Map & Tax Lot No.: | 31W23B 00791 |
| Property ID/Key No.: | 05031601 |

(Affects a portion of Parcel II)

5. Taxes for the year 2023-2024
- | | |
|----------------------|-----------------------------------|
| Tax Amount: | \$9,628.16 |
| Unpaid Balance: | \$9,628.16, plus interest, if any |
| Code No.: | 003-023 |
| Map & Tax Lot No.: | 31W23B 00701MA1 |
| Property ID/Key No.: | 05020852 |

(Affects a portion of Parcel II - Machinery and equipment)

6. City liens, if any, for the city of Wilsonville.

Note: An inquiry has NOT been made concerning the actual status of such liens. A fee of \$25.00 will be charged per tax account each time an inquiry request is made.

THIS IS NOT a title report since no examination has been made of the title to the above described property. Our search for apparent encumbrances was limited to our Tract Indices, and therefore above listings do not include additional matters which might have been disclosed by an examination of the record title. We assume no liability in connection with this Lot Book Service and will not be responsible for errors or omissions therein. The charge for this service will not include supplemental reports, rechecks or other services.

Exhibit "A"

Real property in the County of Clackamas , State of Oregon, described as follows:

PARCEL I:

PARCEL 1, PARTITION PLAT NO. [1990-92](#), IN THE CITY OF WILSONVILLE, COUNTY OF CLACKAMAS AND STATE OF OREGON.

EXCEPTING THEREFROM THAT PORTION CONVEYED TO THE CITY OF WILSONVILLE BY STREET DEDICATION DEED RECORDED MARCH 8, 2021 AS RECORDING NO. [2021-023346](#).

ALSO EXCEPTING THEREFROM THAT PORTION CONVEYED TO THE CITY OF WILSONVILLE BY STATUTORY WARRANTY DEED RECORDED MARCH 8, 2021 AS RECORDING NO. [2021-023347](#).

PARCEL II:

PARCEL 2, PARTITION PLAT NO. [1990-92](#), IN THE CITY OF WILSONVILLE, COUNTY OF CLACKAMAS AND STATE OF OREGON.

PARCEL II-A:

A PERPETUAL EASEMENT FOR ROAD PURPOSES ALONG AND OVER A STRIP 16.00 FEET IN WIDTH ACROSS THE ENTIRE SOUTH END OF THE FOLLOWING DESCRIBED REAL PROPERTY:

PART OF THE THOMAS BAILEY DONATION LAND CLAIM NO. 45 IN TOWNSHIP 3 SOUTH, RANGE 1 WEST, OF THE WILLAMETTE MERIDIAN, IN THE COUNTY OF CLACKAMAS AND STATE OF OREGON, MORE PARTICULARLY DESCRIBED AS FOLLOWS:

BEGINNING AT THE NORTHWEST CORNER OF SAID CLAIM NO. 45;
THENCE EAST 27.91 CHAINS TO WHAT WAS FORMERLY HENRY D. HARMS NORTHWEST CORNER;
THENCE SOUTH 13°15' WEST, 3.17 CHAINS TO THE SOUTHEAST CORNER OF A TRACT CONVEYED TO SCHOOL DISTRICT NO. 23, BY DEED RECORDED IN [BOOK "H", PAGE 164](#), DEED RECORDS, WHICH POINT IS THE TRUE PLACE OF BEGINNING OF THE TRACT TO BE DESCRIBED;
THENCE CONTINUING SOUTH 13°15' WEST, TO THE NORTHEAST CORNER OF TRACT CONVEYED TO HENRY SWARTZ TO SECURITY SAVINGS AND TRUST COMPANY BY DEED RECORDED JANUARY 9, 1907, IN [BOOK 97, PAGE 616](#), DEED RECORDS;
THENCE WEST TRACING THE NORTH LINE OF SAID TRACT CONVEYED TO SECURITY SAVINGS AND TRUST COMPANY BY HENRY SWARTZ TO THE RIGHT OF WAY OF OREGON ELECTRIC RAILWAY;
THENCE NORTHERLY TRACING THE EASTERLY BOUNDARY LINE OF SAID RIGHT OF WAY TO THE SOUTHWEST CORNER OF THAT CERTAIN TRACT CONVEYED TO MILLARD CRISSWELL BY DEED RECORDED IN [BOOK 98, PAGE 503](#), DEED RECORDS;
THENCE EAST TRACING THE SOUTH LINES OF THE CRISSWELL TRACT AND TRACT CONVEYED TO SCHOOL DISTRICT NO. 23, TO THE TRUE PLACE OF BEGINNING.



Todd Prager & Associates_{LLC}

MEMORANDUM

DATE: July 18, 2024

TO: David Adams (Walen Construction)

FROM: Rick Till, ISA Board Certified Master Arborist® PN-8730A

RE: Tree Protection Plan for Development at 30160 OrePac Avenue, Wilsonville

Summary

A parking lot, driveway, storm water systems, and grading of a spoils pile are proposed at 30160 OrePac Avenue in Wilsonville, Oregon. This memorandum summarizes the tree inventory and protection plan for the project. One-hundred and three (103) trees were inventoried near proposed development activity. Seven (7) trees are proposed for removal. This report addresses tree removal and tree protection requirements outlined in the City of Wilsonville Code, Chapter 4, Section 4.600.

Background

A parking lot and access driveways were previously installed without permits. The current proposal includes review of the existing parking lot, installation of new stormwater systems, construction of a new access driveway, and grading of an on-site spoils pile.

The subject property includes multiple tax lots over 10-acres in size. The development area is zoned Future Development Agricultural-Holding (“FDAHI”) with portions of work extending into the Planned Development-Industrial zone (“PDI”). There is a stream and a corresponding Significant Resource Overlay Zone (“SROZ”) running along the western portion of the property, but no development is proposed in that zone.

Assignment

The assignment asked of our firm was:

1. Assess up to 90 trees at the 30160 SW OrePac Avenue Development site. Assessment to include tree species, sizes, physical and structural conditions of the trees, treatment (remove/retain), and any additional necessary comments.
2. In coordination with the project team, identify the trees to be retained and removed.
3. Develop tree removal/protection recommendations in accordance with the City of Wilsonville Code.

Type C Permit (Section 4.610.40)

Type C Permits require a tree survey and site map depicting existing trees on the property, trees to be removed, and tree protection measures. A site map depicting existing trees, trees to be

removed, and protection measures is included as Attachment 1. An inventory of the trees to be removed and the trees to be retained near the proposed development is included as Attachment 2. The following information demonstrates compliance with Type C Permit requirements.

Tree Survey (Section 4.610.40.02(2))

I completed the inventory on March 9, 2024 and July 10, 2024. One hundred sixteen (116) trees were assessed in the vicinity of the proposed development. The following information was collected for each tree: tree tag, common name, scientific name, trunk diameter (DBH), single DBH, approximate canopy radius, health condition rating, structural condition rating, property status (on or off the subject property), pertinent comments, and treatment (remove or retain).

The tree numbers listed on the map in Attachment 1 correspond with the tree numbers listed on the inventory spreadsheet in Attachment 2. Onsite trees were tagged with aluminum tags if accessible. No Oregon white oak (*Quercus garryana*) or Pacific yew (*Taxus brevifolia*) were found on the development site.

Standards for Tree Removal, Relocation, and Replacement (Section 4.610.10)

The proposed new driveway would allow access to the OrePac lumber yard from 5th Street to the south of the project area. The driveway would run along the east property line to avoid a forested swale. The driveway alignment requires removal of seven trees, including four sweet cherries (*Prunus avium*) (trees 132, 133, 134, and 135) and three Douglas-firs (*Pseudotsuga menziesii*) (trees 229, 230, 231). The proposed access drive would run either directly through the trunks of the trees (132, 133, 229, 230, and 231) or within the critical root zone (134 and 135), which is typically 0.5 feet per inch of DBH. Removal of the seven trees is necessary for construction and consistent with Section 4.610.10(H)(1).

Alternative designs that would avoid removal of these trees are not feasible. The cherries, a non-native, naturalized species, are located at a pinch-point between a forested swale in the middle of the property and the railroad to the east. The Douglas-firs are located in the only location to access the existing lumber yard along the eastern edge of the property. Alternative access points would require the removal of other trees.

Tree Protection During Construction (Section 4.620.10)

A typical minimum root protection zone allows encroachments no closer than a radius from a tree of 0.5 feet per inch of DBH if no more than 25 percent of the root protection zone area (estimated at one foot radius per inch of DBH) is impacted. Figure 1 illustrates this concept. This standard may need to be adjusted on a case-by-case basis due to tree health, species, root distribution, whether the tree will be impacted on multiple sides, the specific development proposed, and other factors.

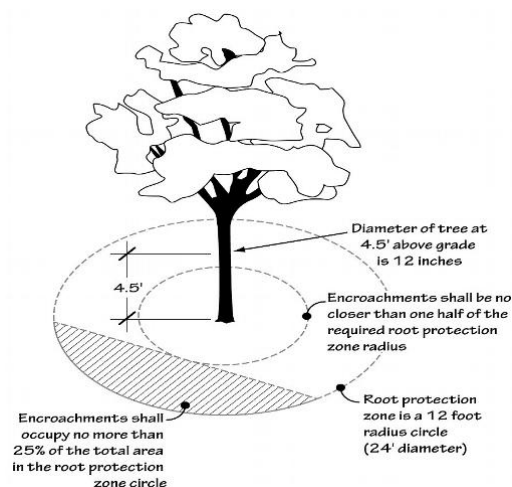

Figure 1: Typical minimum protection zone

For the majority of trees, new ground disturbance will not occur within the typical minimum tree protection zone radius of 0.5 foot per inch of DBH, as shown on the attached tree protection plan (Attachment 2).

For improvements to the existing parking and driveway areas, such as installation of curbs and re-striping, tree protection fencing should be placed along the edge of the asphalt to protect adjacent trees. Any excavation below the existing asphalt surface within the minimum tree protection zone should be supervised by the project arborist.

For tree 209, a 25-inch DBH bigleaf maple (*Acer macrophyllum*), located immediately adjacent to the parking area, it may be beneficial to relocate one of the proposed “landscape areas” to the stall immediately to the south of the tree. This would avoid future conflicts with the trunk and retain a valuable shade tree. Alternatively, curb installation near that tree should leave space for trunk expansion. If excavation is required adjacent to this tree, an arborist should be on-site to supervise the work.

For tree 119, a 92-inch DBH Douglas-fir, a new stormwater detention pond will be installed within approximately 25 feet of the trunk of the tree. Arborist oversight should be required during excavation along the edge of the proposed pond to ensure unnecessary impacts to tree roots are avoided. The final footprint of the stormwater detention pond may be modified to avoid significant structural roots if recommended by the project arborist.

1. **Tree protection fencing.** Tree protection fencing will act as a physical, protective barrier between protected trees and construction.
 - a. *Height:* Provide a minimum 3.5-foot-high hi-visibility fence.
 - b. *Posts & Spacing:* Secure fencing with metal t-stakes no more than 10 feet apart so as not to be moved.
 - c. *Existing Grade:* Install fencing flush to the ground.
 - d. *Locations:* Install fencing as shown in Attachment 2.
 - e. Tree protection fencing shall not be moved without written approval from the project arborist.
 - f. A tree protection fencing detail is on the tree protection plan (Attachment 2).

2. Tree protection signage.

- a. Weatherproof tree protection signage shall be placed on tree protection fencing.
- b. Signage should be placed at intervals of every 30 feet.
- c. See Attachment 3 for an example tree protection sign.

3. Tree protection fencing maintenance and removal.

- a. *Maintenance:* Maintain protection fencing in good effective condition at the approved and inspected location. Fencing that is damaged during site work shall be repaired and placed in the approved location prior to resuming work in the area.
- b. *Removal:* Tree protection fencing may be removed when all work is complete, and the final inspection has occurred.

4. Prevent protection zone impacts. The following activities can cause significant harm to trees and should be prevented.

- a. Dumping of harmful chemicals and materials, such as paints, thinners, cleaning solutions, petroleum products, concrete or dry wall excess, construction debris, or run-off;
- b. Storage of materials such as building supplies, soil, rocks, or waste items;
- c. Placement of portable toilets, drop-boxes, or similar temporary items;
- d. Parking of vehicles or equipment; and,
- e. Excavation, trenching, grading, root pruning, or similar activities unless directed by an arborist present on site.

5. Project arborist oversight. The project arborist should be on-site during excavation of the stormwater pond near tree 119 and if excavation occurs adjacent to tree 209.

6. Erosion control. Any required sediment fencing shall be routed outside of tree protection fencing to protect the root systems of the trees to be retained.

7. Additional tree protection measures. Additional tree protection measures consistent with industry standards and best management practices are in Attachment 4.

8. Report sharing. Share this report in its entirety with the project team and construction staff.

////

////

////

////

/////

Conclusion

The proposed development at OrePac facility can be constructed in compliance with the City of Wilsonville development code. Seven trees are proposed for removal as needed for the proposed development. Tree protection fencing and arborist oversight will protect the remaining on-site trees from impacts.

Please contact me if you have any questions, concerns, or need additional information.

Sincerely,



Rick Till

ISA Board Certified Master Arborist® PN-8358B
ISA Qualified Tree Risk Assessor
Member, American Society of Consulting Arborists
rick@toddparger.com | 503-750-6599

Enclosures: Attachment 1 – Tree Inventory
 Attachment 2 – Tree Inventory Map and Protection Plan
 Attachment 3 – Tree Protection Signage
 Attachment 4 – Tree Protection Recommendations
 Attachment 5 – Assumptions and Limiting Conditions



Attachment 2
Tree Inventory - June 17, 2024
OrePac Parking Lot

Tree Tag	Survey	Common Name	Scientific Name	DBH ¹ (in)	Single DBH ² (in)	C-Rad ³ (ft)	Health Condition ⁴	Structural Condition ⁴	Property Status ⁵	Comments	Treatment
117	27"FIR	Douglas-fir	<i>Pseudotsuga menziesii</i>	27	27	20	good	good	on		retain
118	7"DEC	English hawthorn	<i>Crataegus monogyna</i>	8	8	12	good	fair	on	non-native, naturalized	retain
119	92"FIR	Douglas-fir	<i>Pseudotsuga menziesii</i>	92	92	40	good	fair	on	8 stems originating at 5' to 8' height	retain
122	58"MAPLE	bigleaf maple	<i>Acer macrophyllum</i>	51	51	40	fair	fair	on	Measured at 2', ganoderma conk on west sinus, unknown fungi near trunk to east, some top dieback, internal decay, tree can be managed as asset, but requires maintenance and monitoring	retain
124	22"PINE	Douglas-fir	<i>Pseudotsuga menziesii</i>	24	24	24	good	fair	on	one-sided	retain
125	28"PINE	Douglas-fir	<i>Pseudotsuga menziesii</i>	30	30	24	good	fair	on	one-sided	retain
126	26"PINE	Douglas-fir	<i>Pseudotsuga menziesii</i>	28	28	21	fair	fair	on	thin, one-sided, bend in trunk	retain
127	25"PINE	Douglas-fir	<i>Pseudotsuga menziesii</i>	26	26	21	fair	fair	on	thin, one-sided, hangers	retain
128	20"PINE	Douglas-fir	<i>Pseudotsuga menziesii</i>	20	20	9	fair	fair	on	suppressed, narrow crown	retain
129	39"PINE	Douglas-fir	<i>Pseudotsuga menziesii</i>	39	39	24	good	fair	on	one-sided	retain
130	32"PINE	Douglas-fir	<i>Pseudotsuga menziesii</i>	34	34	24	good	fair	on	part shaded	retain
131	33"DEC	black walnut	<i>Juglans nigra</i>	37	37	40	fair	fair	on	deadwood, codominant stems	retain
132	13"DEC	sweet cherry	<i>Prunus avium</i>	13	13	20	fair	fair	on	top dieback, non-native naturalized	remove
133	10"DEC	sweet cherry	<i>Prunus avium</i>	9	9	18	fair	fair	on	one-sided, trunk damage, non-native naturalized	remove
134	16"DEC	sweet cherry	<i>Prunus avium</i>	16	16	25	fair	poor	on	heavy phototropic lean, non-native naturalized	remove
135	17"DEC	sweet cherry	<i>Prunus avium</i>	15	15	24	fair	fair	on	part suppressed, one-sided, non-native naturalized	remove
136	20"MAPLE	bigleaf maple	<i>Acer macrophyllum</i>	26	26	36	good	fair	on	one-sided	retain
137	35"MAPLE	bigleaf maple	<i>Acer macrophyllum</i>	31	31	25	fair	fair	on	historic codominant stem failure at base, good wound wood, low live crown ratio	retain
138	56"PINE	Douglas-fir	<i>Pseudotsuga menziesii</i>	56	56	25	good	fair	on	dia estimated, historic shading to north	retain
139	14"MAPLE	bigleaf maple	<i>Acer macrophyllum</i>	14	14	25	good	fair	on	one-sided	retain
140	14"MAPLE	bigleaf maple	<i>Acer macrophyllum</i>	15	15	30	good	fair	on	heavy phototropic lean	retain
141	10"DEC	sweet cherry	<i>Prunus avium</i>	11	11	5	poor	poor	on	ivy, shade suppressed, thin, non-native naturalized	retain
142	6"DEC	sweet cherry	<i>Prunus avium</i>	6	6	9	fair	fair	on	ivy, non-native naturalized	retain
143	15"19"MAPLE	bigleaf maple	<i>Acer macrophyllum</i>	19, 15	24	40	fair	poor	on	codominant at base, 19" stem runs horizontal to ground for 15', interesting specimen value	retain
144	30"DEC	Oregon ash	<i>Fraxinus latifolia</i>	30	30	24	fair	poor	on	dieback, phototropic lean (no obvious EAB)	retain
145	15"DEC	sweet cherry	<i>Prunus avium</i>	13	13	20	poor	poor	on	ivy, heavy lean	retain
146	18"MAPLE	bigleaf maple	<i>Acer macrophyllum</i>	18	18	30	good	fair	on	one-sided	retain
147	18"MAPLE	bigleaf maple	<i>Acer macrophyllum</i>	20	20	30	good	fair	on	codominant at 10'	retain
148	12"MAPLE	bigleaf maple	<i>Acer macrophyllum</i>	13	13	20	good	fair	on	one-sided	retain
149	24"MAPLE	bigleaf maple	<i>Acer macrophyllum</i>	24	24	25	good	fair	on	dia estimated, ivy, broken limbs	retain
150	18"MAPLE	bigleaf maple	<i>Acer macrophyllum</i>	17	17	18	poor	poor	on	significant trunk wound w/ response growth, heavy lean into/on tree 151, habitat tree	retain
151	14"MAPLE	Douglas-fir	<i>Pseudotsuga menziesii</i>	15	15	12	fair	poor	on	heavily suppressed, supporting tree 150	retain
152	25"PINE	Douglas-fir	<i>Pseudotsuga menziesii</i>	25	25	21	good	good	on		retain
153	7"DEC	English hawthorn	<i>Crataegus monogyna</i>	7	7	15	poor	poor	on	one-sided, lean, non-native naturalized	retain
154	12"DEC	English hawthorn	<i>Crataegus monogyna</i>	14	14	18	poor	poor	on	codominant, one-sided, lean, non-native naturalized	retain
155	14"DEC	sweet cherry	<i>Prunus avium</i>	14	14	18	poor	poor	on	one-sided, low live crown ratio, non-native naturalized	retain
156	7"DEC	sweet cherry	<i>Prunus avium</i>	7	7	20	poor	poor	on	heavy lean, low live crown ratio, non-native naturalized	retain
157	12"DEC	sweet cherry	<i>Prunus avium</i>	12	12	15	fair	fair	on	dia estimated, one-sided, non-native naturalized	retain



Attachment 2
Tree Inventory - June 17, 2024
OrePac Parking Lot

Tree Tag	Survey	Common Name	Scientific Name	DBH ¹ (in)	Single DBH ² (in)	C-Rad ³ (ft)	Health Condition ⁴	Structural Condition ⁴	Property Status ⁵	Comments	Treatment
158	15"DEC	sweet cherry	<i>Prunus avium</i>	14	14	15	fair	good	on	thin, non-native naturalized	retain
159	(2)9"DEC	sweet cherry	<i>Prunus avium</i>	9	9	30	poor	very poor	on	codominant at base, one stem dead, heavy lean, non-native naturalized	retain
160	15"DEC	sweet cherry	<i>Prunus avium</i>	15	15	15	fair	fair	on	one-sided, lean, non-native naturalized	retain
161	12"DEC	sweet cherry	<i>Prunus avium</i>	12	12	30	poor	poor	on	tip dieback, heavy lean, non-native naturalized	retain
162	9"DEC	sweet cherry	<i>Prunus avium</i>	9	9	21	poor	very poor	on	heavy lean, tip dieback, non-native naturalized	retain
163	12"DEC	sweet cherry	<i>Prunus avium</i>	12	12	15	poor	very poor	on	dia estimated, leaning, dieback, non-native naturalized	retain
164	12"DEC	sweet cherry	<i>Prunus avium</i>	12	12	15	poor	very poor	on	dia estimated, leaning, dieback, non-native naturalized	retain
165	10"12"DEC	sweet cherry	<i>Prunus avium</i>	11, 11	16	18	very poor	very poor	on	codominant at base, 1 failed at 10', non-native naturalized	retain
200	arborist estimated	Douglas-fir	<i>Pseudotsuga menziesii</i>	28, 31	42	30	good	fair	on	codominant stems at base	retain
201	arborist estimated	Douglas-fir	<i>Pseudotsuga menziesii</i>	34	34	21	good	fair	on	one-sided	retain
202	arborist estimated	Western red-cedar	<i>Thuja plicata</i>	23	23	15	good	fair	on	part shaded	retain
203	arborist estimated	white oak	<i>Quercus alba</i>	>40	40	48	good	good	on	dia estimated	retain
204	arborist estimated	bigleaf maple	<i>Acer macrophyllum</i>	18	18	30	good	fair	on	one-sided	retain
205	arborist estimated	Douglas-fir	<i>Pseudotsuga menziesii</i>	30	30	24	good	fair	on	dia estimated, one-sided	retain
206	arborist estimated	Douglas-fir	<i>Pseudotsuga menziesii</i>	22	22	21	good	fair	on	dia estimated, one-sided	retain
207	arborist estimated	Douglas-fir	<i>Pseudotsuga menziesii</i>	20	20	21	good	fair	on	dia estimated, one-sided	retain
208	arborist estimated	Douglas-fir	<i>Pseudotsuga menziesii</i>	24	24	24	good	fair	on	dia estimated, one-sided	retain
209	arborist estimated	bigleaf maple	<i>Acer macrophyllum</i>	25	25	30	fair	fair	on	one-sided, old chain-link embedded, new fence constructed around tree, root flair within 1' of asphalt, decay pocked at 6'	retain
210	arborist estimated	Douglas-fir	<i>Pseudotsuga menziesii</i>	20	20	21	good	fair	on	dia estimated, one-sided	retain
211	arborist estimated	Douglas-fir	<i>Pseudotsuga menziesii</i>	20	20	20	good	fair	on	dia estimated, one-sided	retain
212	arborist estimated	Douglas-fir	<i>Pseudotsuga menziesii</i>	25	25	24	good	fair	on	dia estimated, one-sided	retain
213	arborist estimated	Douglas-fir	<i>Pseudotsuga menziesii</i>	18	18	21	good	fair	on	dia estimated, one-sided	retain
214	arborist estimated	Douglas-fir	<i>Pseudotsuga menziesii</i>	30	30	18	good	fair	on	one-sided	retain
215	arborist estimated	Douglas-fir	<i>Pseudotsuga menziesii</i>	17	17	15	poor	fair	on	significant dieback	retain
216	arborist estimated	shore/lodgepole pine	<i>Pinus contorta</i>	22	22	20	good	good	on		retain
217	arborist estimated	shore/lodgepole pine	<i>Pinus contorta</i>	18	18	18	good	fair	on	one-sided	retain
218	arborist estimated	shore/lodgepole pine	<i>Pinus contorta</i>	26	26	18	good	fair	on	one-sided	retain



Attachment 2
Tree Inventory - June 17, 2024
OrePac Parking Lot

Tree Tag	Survey	Common Name	Scientific Name	DBH ¹ (in)	Single DBH ² (in)	C-Rad ³ (ft)	Health Condition ⁴	Structural Condition ⁴	Property Status ⁵	Comments	Treatment
219	arborist estimated	Douglas-fir	<i>Pseudotsuga menziesii</i>	29	29	20	fair	fair	on	dead branches	retain
220	arborist estimated	Douglas-fir	<i>Pseudotsuga menziesii</i>	22	22	18	fair	fair	on	thin foliage	retain
221	arborist estimated	Douglas-fir	<i>Pseudotsuga menziesii</i>	26	26	18	very poor	poor	on	dead top, thin	retain
222	arborist estimated	Douglas-fir	<i>Pseudotsuga menziesii</i>	30	30	24	good	good	on		retain
223	arborist estimated	Douglas-fir	<i>Pseudotsuga menziesii</i>	26	26	21	fair	fair	on	thin foliage	retain
224	arborist estimated	Douglas-fir	<i>Pseudotsuga menziesii</i>	24	24	15	fair	fair	on	thin foliage	retain
225	arborist estimated	shore/lodgepole pine	<i>Pinus contorta</i>	16	16	21	good	fair	on	one-sided	retain
226	arborist estimated	shore/lodgepole pine	<i>Pinus contorta</i>	15	15	18	poor	fair	on	thin branching	retain
227	arborist estimated	shore/lodgepole pine	<i>Pinus contorta</i>	25	25	21	good	good	on		retain
228	arborist estimated	English hawthorn	<i>Crataegus monogyna</i>	10, 9	13	10	good	fair	on	codominant stems, non-native naturalized	retain
229	arborist estimated	Douglas-fir	<i>Pseudotsuga menziesii</i>	36	36	24	good	good	on		remove
230	arborist estimated	Douglas-fir	<i>Pseudotsuga menziesii</i>	30	30	18	good	fair	on	codominant at 20'	remove
231	arborist estimated	Douglas-fir	<i>Pseudotsuga menziesii</i>	30	30	20	good	fair	on	one-sided	remove
232	arborist estimated	bigleaf maple	<i>Acer macrophyllum</i>	14	14	21	very poor	very poor	on	1/2 dead, one-sided	retain
233	arborist estimated	bigleaf maple	<i>Acer macrophyllum</i>	12	12	18	fair	fair	on	small leaves	retain
234	arborist estimated	bigleaf maple	<i>Acer macrophyllum</i>	8	8	12	poor	poor	on	dead strip on trunk	retain
235	arborist estimated	bigleaf maple	<i>Acer macrophyllum</i>	16	16	18	poor	poor	on	dieback, dead strip	retain
236	arborist estimated	bigleaf maple	<i>Acer macrophyllum</i>	24	24	21	poor	poor	on	tip dieback	retain
237	arborist estimated	bigleaf maple	<i>Acer macrophyllum</i>	20	20	24	fair	fair	on	codominant at 3'	retain
238	arborist estimated	bigleaf maple	<i>Acer macrophyllum</i>	10	10	15	fair	fair	on	narrow, suppressed	retain
239	arborist estimated	bigleaf maple	<i>Acer macrophyllum</i>	16	16	18	fair	fair	on	one-sided	retain
240	arborist estimated	Douglas-fir	<i>Pseudotsuga menziesii</i>	21	21	18	good	fair	on	one-sided	retain
241	arborist estimated	Douglas-fir	<i>Pseudotsuga menziesii</i>	16	16	18	good	fair	on	one-sided	retain
242	arborist estimated	Douglas-fir	<i>Pseudotsuga menziesii</i>	20	20	21	good	fair	on	one-sided	retain
243	arborist estimated	Douglas-fir	<i>Pseudotsuga menziesii</i>	15	15	15	fair	fair	on	suppressed	retain
244	arborist estimated	Douglas-fir	<i>Pseudotsuga menziesii</i>	15	15	18	fair	fair	on	suppressed	retain



Attachment 2
Tree Inventory - June 17, 2024
OrePac Parking Lot

Tree Tag	Survey	Common Name	Scientific Name	DBH ¹ (in)	Single DBH ² (in)	C-Rad ³ (ft)	Health Condition ⁴	Structural Condition ⁴	Property Status ⁵	Comments	Treatment
245	arborist estimated	Douglas-fir	<i>Pseudotsuga menziesii</i>	19	19	18	fair	fair	on	one-sided	retain
246	arborist estimated	Douglas-fir	<i>Pseudotsuga menziesii</i>	18	18	18	good	fair	on	one-sided	retain
247	arborist estimated	shore/lodgepole pine	<i>Pinus contorta</i>	12	12	15	good	fair	on	one-sided	retain
248	arborist estimated	Douglas-fir	<i>Pseudotsuga menziesii</i>	15	15	15	poor	fair	on	thin, dead tips	retain
249	arborist estimated	Douglas-fir	<i>Pseudotsuga menziesii</i>	7	7	9	fair	fair	on	suppressed	retain
250	arborist estimated	Douglas-fir	<i>Pseudotsuga menziesii</i>	15	15	21	fair	fair	on	one-sided	retain
251	arborist estimated	Douglas-fir	<i>Pseudotsuga menziesii</i>	18	18	15	good	fair	on	one-sided	retain
252	arborist estimated	Douglas-fir	<i>Pseudotsuga menziesii</i>	23	23	24	good	good	on		retain
253	arborist estimated	bigleaf maple	<i>Acer macrophyllum</i>	8	8	24	good	fair	on	one-sided, phototropic lean	retain
254	arborist estimated	bigleaf maple	<i>Acer macrophyllum</i>	11	11	24	good	fair	on	one-sided, phototropic lean	retain
255	arborist estimated	bigleaf maple	<i>Acer macrophyllum</i>	14	14	18	good	fair	on	one-sided	retain
256	arborist estimated	bigleaf maple	<i>Acer macrophyllum</i>	17, 22, 23	36	30	good	fair	on	codominant at 3'	retain

¹DBH is the trunk diameter in inches measured per International Society of Arboriculture (ISA) standards.

²Single DBH is the trunk diameter of a multi-stem tree converted to a single number according to the following formula: square root of the sum of the squared diameter of each trunk at 4½ feet above mean ground

³C-Rad is the approximate crown radius in feet.

⁴Condition and Structure ratings range from dead, very poor, poor, fair, to good.

⁵Property status categorizes trees as on the property, off the property, or on the boundary between two properties. Boundary trees proposed for removal will require approval from the neighboring property.

STOP!
DO NOT MOVE THIS FENCE.

TREE PROTECTION ZONE

Inside the fencing is a tree protection zone, not to be disturbed unless prior approval has been obtained from the project arborist.

For questions regarding tree protection please call the project arborist:
Todd Prager & Associates, LLC
todd@toddprager.com
971.295.4835

Attachment 4

Tree Protection Recommendations

The following recommendations will help to ensure that the trees to be retained are adequately protected:

Before Construction Begins

1. **Notify all contractors of the tree protection procedures.** For successful tree protection on a construction site, all contractors must know and understand the goals of tree protection.
 - a. Hold a tree protection meeting with all contractors to explain the goals of tree protection.
 - b. Have all contractors sign memoranda of understanding regarding the goals of tree protection. The memoranda should include a penalty for violating the tree protection plan. The penalty should equal the appraised value of the tree(s) within the violated tree protection zone per the current Trunk Formula Method as outlined in the current edition of the *Guide for Plant Appraisal* plus any resulting fines by government agencies.
 - c. The penalty should be paid to the owner of the property.
2. **Fencing.**
 - a. Establish fencing around each tree or group of trees to be retained.
 - b. The fencing should be put in place before the ground is cleared to protect the trees and the soil around the trees from disturbance.
 - c. Fencing should be established by the project arborist based on the needs of the trees to be protected and to facilitate construction.
 - d. Fencing should consist of 3.5-foot-high hi-visibility mesh fencing secured to metal posts to prevent it from being moved by contractors, sagging, or falling down.
 - e. Fencing should remain in the position that is established by the project arborist and not be moved without approval from the project arborist until final project approval.
3. **Signage.**
 - a. All tree protection fencing should be provided with signage so that all contractors understand the purpose of the fencing.
 - b. Signage should be placed every 30 feet.
 - c. Signage should be weathered and secured to fencing.
 - d. Signage has been included in Attachment 3.

During Construction

1. Protection Guidelines Within the Tree Protection Zones.

- a. No traffic should be allowed within the tree protection zones. This includes but is not limited to vehicle, heavy equipment, or even repeated foot traffic.
 - b. No storage of materials including but not limiting to soil, construction material, or waste from the site should be permitted within the tree protection zones. Waste includes but is not limited to concrete wash out, gasoline, diesel, paint, cleaner, thinners, etc.
 - c. Construction trailers should not to be parked/placed within the tree protection zones.
 - d. No vehicles should be allowed to park within the tree protection zones.
 - e. No activity should be allowed that will cause soil compaction within the tree protection zones.
2. The trees should be protected from any cutting, skinning or breaking of branches, trunks, or woody roots.
 3. The project arborist should be notified prior to the cutting of woody roots from trees that are to be retained to evaluate and oversee the proper cutting of roots with sharp cutting tools. Cut roots should be immediately covered with soil or mulch to prevent them from drying out.
 4. No grade changes should be allowed within the tree protection zones.
 5. Trees that have woody roots cut should be provided supplemental water during the summer months.
 6. Any necessary passage of utilities through the tree protection zones should be by means of tunneling under woody roots by hand digging or boring with oversight by the project arborist.
 7. Any deviation from the recommendations in this section should receive prior approval from the project arborist.

After Construction

1. **Carefully landscape the areas within the tree protection zones.** Do not allow trenching for irrigation or other utilities within the tree protection zones.
2. **Carefully plant new plants within the tree protection zones.** Avoid cutting the woody roots of trees that are retained.
3. **Irrigation.** Do not install permanent irrigation within the tree protection zones unless it is drip irrigation to support a specific planting, or the irrigation is approved by the project arborist.
4. **Drainage.** Provide adequate drainage within the tree protection zones and do not alter soil hydrology significantly from existing conditions for the trees to be retained.
5. **Inspect the landscape for pests and disease.** Provide for the ongoing inspection and treatment of insect and disease populations that can damage the retained trees and plants.
6. **Fertilization.** The retained trees may need to be fertilized if recommended by the project arborist.
7. Any deviation from the recommendations in this section should receive prior approval from the project arborist.

Attachment 5

Assumptions and Limiting Conditions

1. Any legal description provided to the consultant is assumed to be correct. The site plans and construction information provided by Walen Construction and its consultants were the basis of the information provided in this report.
2. It is assumed that this property is not in violation of any codes, statutes, ordinances, or other governmental regulations.
3. The consultant is not responsible for information gathered from others involved in various activities pertaining to this project. Care has been taken to obtain information from reliable sources.
4. Loss or alteration of any part of this delivered report invalidates the entire report.
5. Drawings and information contained in this report may not be to scale and are intended to be used as display points of reference only.
6. The consultant's role is only to make recommendations. Inaction on the part of those receiving the report is not the responsibility of the consultant.
7. The purpose of this report is to:
 - a. Assess up to 90 trees at the 30160 SW OrePac Avenue Development site. Assessment to include tree species, sizes, physical and structural conditions of the trees, treatment (remove/retain), and any additional necessary comments.
 - b. In coordination with project team, identify the trees to be retained and removed.
 - c. Develop tree removal/protection recommendations in accordance with the City of Wilsonville Code.

Griffin Land Surveying Inc.

6107 SW Murray Blvd. #409 – Beaverton, OR. 97008

Office: (503) 201-3116

OrePac PLA

Project: 0864

Transfer Tract
Assessors Maps 31W23B
City of Wilsonville, Clackamas County, OR.

A tract of land situated in the N.W. 1/4 of Section 23, T.3S., R.1W., W.M. in the City of Wilsonville, Clackamas County, Oregon, being more particularly described as follows:

Beginning at the Southeast corner of Parcel 1, Partition Plat No. 1990-92, Clackamas County Plat Records; thence N 84°56'57" W along the South line of said Parcel 1, 236.40; thence S 29°14'31" W, 85.42 feet; thence S 23°17'05" W, 54.13 feet; thence S 14°59'27" W, 55.38 feet; thence S 8°41'10" W, 45.49 feet; thence S 14°29'48" E, 48.74 feet; thence S 7°23'26" E, 74.27 feet; thence S 8°49'39" W, 10.40 feet to the North right of way line of 5th Street; thence Easterly along said North right of way line to the North line of Parcel 2 of that tract described by Deed to Meadows148, LLC, recorded in Document No. 2016-063876, Clackamas County Records; thence S 88°28'09" E along said North line and its Easterly extension, 642.10 feet to the West right of way line of the Oregon Electric Railroad; thence Northerly along said West right of way line to the Southeast corner of Tract 'A' of said Partition Plat No. 1990-92; thence N 88°26'57" W along the South line of said Tract 'A', 494.00 feet; thence N 5°03'02" E along the West line of said Tract 'A' and the West line of Parcel 2 of said Partition Plat No. 1990-92, 178.47 feet to the point of beginning.

Contains 6.2638 acres.

The courses above are derived from a Record of Survey by Griffin Land Surveying Inc, filed in the Clackamas County Survey Records.



Griffin Land Surveying Inc.

6107 SW Murray Blvd. #409 – Beaverton, OR. 97008

Office: (503) 201-3116

OrePac PLA
Project: 0864

Tract 1 (adjusted)
Assessors Map 31W23B
City of Wilsonville, Clackamas County, OR.

A tract of land situated in the N.W. 1/4 of Section 23, T.3S., R.1W., W.M. in the City of Wilsonville, Clackamas County, Oregon, being more particularly described as follows:

Commencing at the Southeast corner of Parcel 1, Partition Plat No. 1990-92, Clackamas County Plat Records; thence N 84°56'57" W along the South line of said Parcel 1, 236.40 feet to the TRUE POINT OF BEGINNING; thence S 29°14'31" W, 85.42 feet; thence S 23°17'05" W, 54.13 feet; thence S 14°59'27" W, 55.38 feet; thence S 8°41'10" W, 45.49 feet; thence S 14°29'48" E, 48.74 feet; thence S 7°23'26" E, 74.27 feet; thence S 8°49'39" W, 10.40 feet to the North right of way line of 5th Street; thence Westerly along said North right of way line to the East right of way line of Industrial Way as recorded in Deed Document 2021-025394, Clackamas County Records; thence Northerly along said East right of way line and the East right of way line of Kinsman Road to the West line of said Parcel 1; thence Southerly along the West lines of said Parcel 1 to the point of beginning.

Contains 6.4768 acres.

The courses above are derived from a Record of Survey by Griffin Land Surveying Inc, filed in the Clackamas County Survey Records.



Griffin Land Surveying Inc.

6107 SW Murray Blvd. #409 – Beaverton, OR. 97008

Office: (503) 201-3116

OrePac PLA
Project: 0864

Tract 2 (adjusted)
Assessors Maps 31W23B, 31W23BD
City of Wilsonville, Clackamas County, OR.

A tract of land situated in the N.W. 1/4 of Section 23, T.3S., R.1W., W.M. in the City of Wilsonville, Clackamas County, Oregon, being more particularly described as follows:

Beginning at the Southeast corner of Parcel 1, Partition Plat No. 1990-92, Clackamas County Plat Records; thence N 84°56'57" W along the South line of said Parcel 1, 236.40; thence S 29°14'31" W, 85.42 feet; thence S 23°17'05" W, 54.13 feet; thence S 14°59'27" W, 55.38 feet; thence S 8°41'10" W, 45.49 feet; thence S 14°29'48" E, 48.74 feet; thence S 7°23'26" E, 74.27 feet; thence S 8°49'39" W, 10.40 feet to the North right of way line of 5th Street; thence Easterly along said North right of way line to the North line of Parcel 2 of that tract described by Deed to Meadows148, LLC, recorded in Document No. 2016-063876, Clackamas County Records; thence S 88°28'09" E along said North line and the North line of that tract described by Deed to Meadows148, LLC, recorded in Document No. 2017-018340, Clackamas County Records, 442.12 feet to the Northeast corner of said tract described in Document No. 2017-018340; thence S 8°54'35" E along the East line of said tract, 197.38 feet to the North right of way line of said 5th Street; thence Easterly along said North right of way line to the West right of way line of the Oregon Electric Railroad; thence Northerly along said West right of way line to the Southeast corner of Tract 'A' of said Partition Plat No. 1990-92; thence N 88°26'57" W along the South line of said Tract 'A', 494.00 feet; thence N 5°03'02" E along the West line of said Tract 'A' and the West line of Parcel 2 of said Partition Plat No. 1990-92, 178.47 feet to the point of beginning.

Contains 7.0868 acres.

The courses above are derived from a Record of Survey by Griffin Land Surveying Inc, filed in the Clackamas County Survey Records.



RECEIVED: _____

ACCEPTED FOR FILING: _____

SURVEY NUMBER: _____

Record of Survey

PROPERTY LINE ADJUSTMENT
WITHIN THE THOMAS BAILEY DLC 45
IN THE N.W. 1/4 OF SECTION 23, T.3S., R.1W., W.M.
CITY OF WILSONVILLE, CLACKAMAS COUNTY, OREGON,

JULY 8, 2024

FOR: INLAND PACIFIC PROPERTIES, LLLC

NARRATIVE:

THE BASIS OF BEARINGS IS THE WEST LINE OF THE THOMAS BAILEY DLC 45 PER SN 2017-241. THIS SURVEY WAS PERFORMED TO SET OUT THE BOUNDARIES OF A PROPERTY LINE ADJUSTMENT PER CITY OF WILSONVILLE PLANNING FILE NO: DB24-0001 OREPAC SITE IMPROVEMENTS.

MONUMENTS WERE HELD ALONG THE CENTERLINES OF 5TH STREET AND KINSMAN ROAD, ALONG WITH CONTROL POINTS SHOWN ON SN 2017-241 AND 2024-004 TO ESTABLISH SAID ROADS AND RIGHT OF WAY LINES. DATA WAS USED PER SAID SURVEYS, FOR THE POSITION OF MONUMENTS DESTROYED BY CONSTRUCTION.

THE SOUTH AND WEST LINES OF PARTITION PLAT NO. 1990-92 WAS ESTABLISHED BY HOLDING PLAT DATA AND THE THREE MONUMENTS ALONG SAID LINES AS SHOWN.

DATA WAS HELD PER SN 2017-241 TO ESTABLISH THE CENTERLINE AND RIGHT OF WAY LINE OF OREGON ELECTRIC RAILROAD.

ALL OF THE PROPERTIES BOUNDED BY 5TH STREET, INDUSTRIAL WAY, KINSMAN STREET, PARTITION PLAT NO. 1990-92 AND THE RAILROAD ARE OWNED BY THE SAME ENTITY. THE LINE COMMON TO PARCEL 1 (D1) AND (D2) HAVE THE SAME DIRECTION CALL (SOUTH 10'16" EAST). THE NORTH CORNER OF THE WEST LINE OF PARCEL 1 (D1) (DESCRIBED FROM THE EAST) AND EAST LINE OF (D2) (DESCRIBED FROM THE WEST) ARE IN CONFLICT. FOR THE PURPOSE OF COMPUTING AREAS FOR THIS ADJUSTMENT I HAVE HELD THE MONUMENTS AND DATA FROM THE 1990 SURVEY SN 3258 TO ESTABLISH THE LINE. FOR THE NORTH LINE I HELD THE IRON PIPE NEAR THE DLC LINE AND THE IR NEAR THE RAILROAD RIGHT OF WAY PER SN 10773 AND THE IR NEAR THE NW CORNER OF (D2). THE NE CORNER OF (D2) WAS ESTABLISHED AT DEED DISTANCE (203.30') PER THE DEED AND SN 3258. THE EAST LINE OF (D2) WAS ESTABLISHED BY HOLDING THE RRS IN 5TH STREET PER SN 3258.

THE NEW PROPERTY LINE WAS SET OUT AT THE DIRECTION OF THE CLIENT AS SHOWN. THE ADJUSTMENT DEED IS RECORDED AS DOCUMENT NO. _____, CLACKAMAS COUNTY RECORDS.

APPROVAL:

CITY OF WILSONVILLE PLANNING FILE NO:
DB24-0001 OREPAC SITE IMPROVEMENTS.

BY: _____ DATE: _____

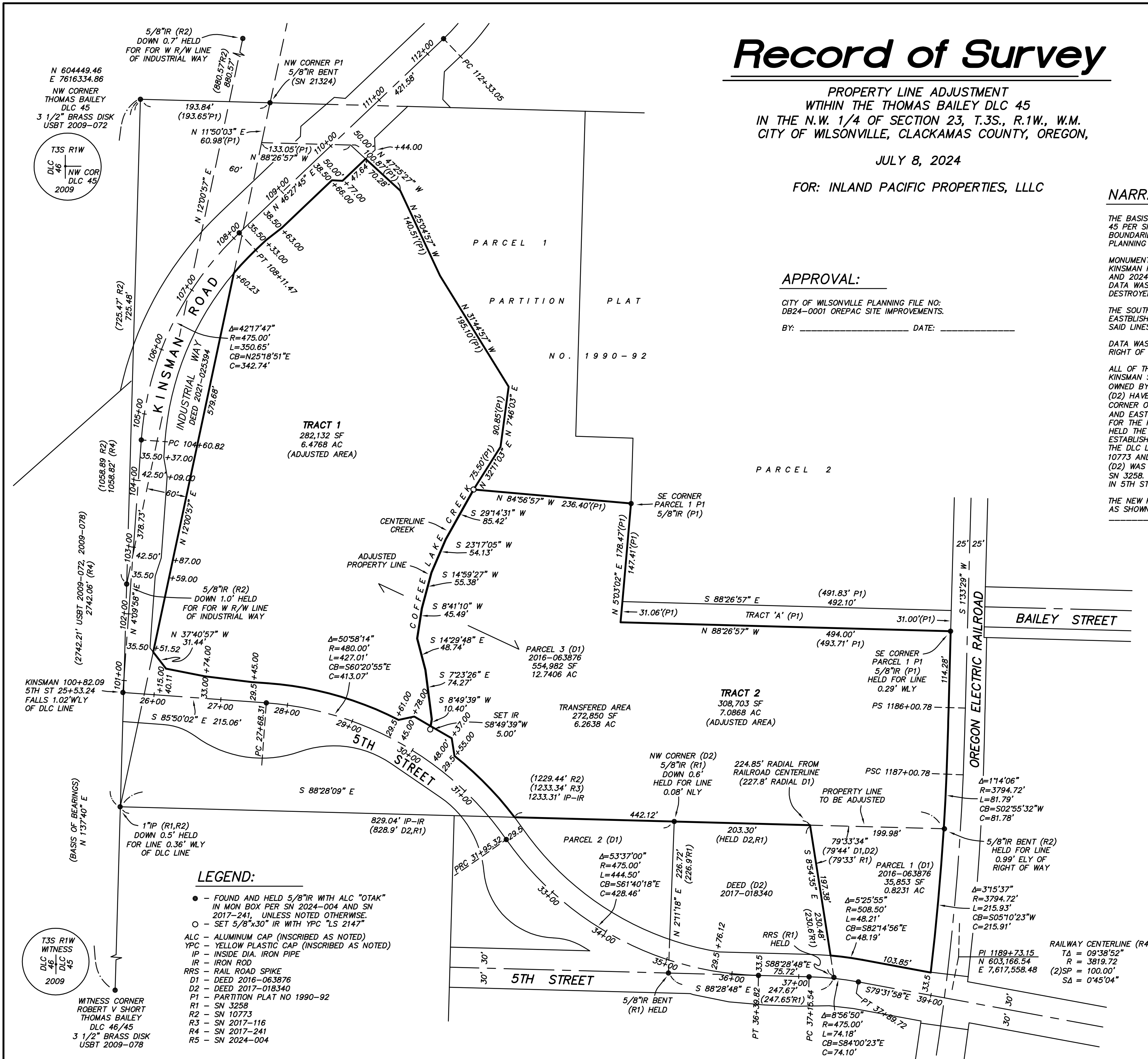

LEGEND:

- - FOUND AND HELD 5/8" IR WITH ALC "OTAK" IN MON BOX PER SN 2024-004 AND SN 2017-241, UNLESS NOTED OTHERWISE.
- - SET 5/8"x30" IR WITH YPC "LS 2147"
- ALC - ALUMINUM CAP (INSCRIBED AS NOTED)
- YPC - YELLOW PLASTIC CAP (INSCRIBED AS NOTED)
- IP - INSIDE DIA. IRON PIPE
- IR - IRON ROD
- RRS - RAIL ROAD SPIKE
- D1 - DEED 2016-063876
- D2 - DEED 2017-018340
- P1 - PARTITION PLAT NO 1990-92
- R1 - SN 3258
- R2 - SN 10773
- R3 - SN 2017-116
- R4 - SN 2017-241
- R5 - SN 2024-004

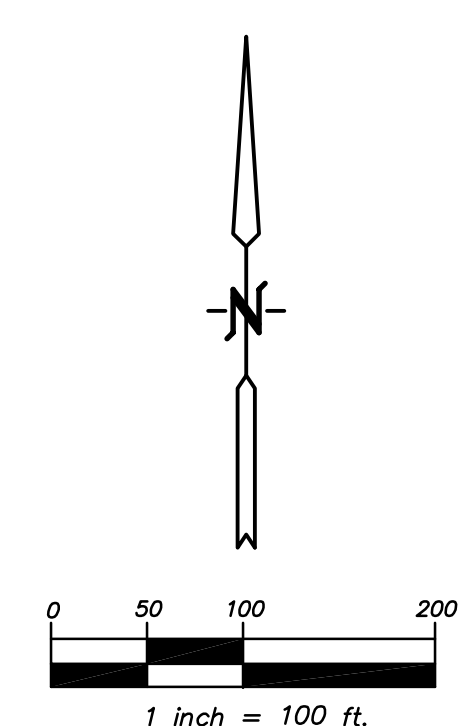

REGISTERED
PROFESSIONAL
LAND SURVEYOR

Kenneth D. Griffin

OREGON
JULY 26, 1985
KENNETH D. GRIFFIN
2147
RENEWS: 6/30/25
0864 OREPAC PLA

GRIFFIN LAND SURVEYING INC.
6107 SW MURRAY BLVD. #409
BEAVERTON, OR. 97008
PHONE: (503)201-3116

N 604449.46
E 7616334.86
NW CORNER
THOMAS BAILEY
DLC 45
3 1/2" BRASS DISK
USBT 2009-072

T3S R1W
DLC 46
NW COR
DLC 45
2009

T3S R1W
DLC 46
DLC 45
2009

WITNESS CORNER
ROBERT V SHORT
THOMAS BAILEY
DLC 46/45
3 1/2" BRASS DISK
USBT 2009-078

Griffin Land Surveying Inc.

6107 SW Murray Blvd. #409 – Beaverton, OR. 97008

Office: (503) 201-3116

OrePac PLA
Project: 0864

**Zone Map Amendment Subject Area
Assessors Maps 31W23B, 31W23BD
City of Wilsonville, Clackamas County, OR.**

A tract of land situated in the N.W. 1/4 of Section 23, T.3S., R.1W., W.M. in the City of Wilsonville, Clackamas County, Oregon, being more particularly described as follows:

Beginning at the Southeast corner of Parcel 1, Partition Plat No. 1990-92, Clackamas County Plat Records; thence N 84°56'57" W along the South line of said Parcel 1, 236.40; thence S 29°14'31" W, 85.42 feet; thence S 23°17'05" W, 54.13 feet; thence S 14°59'27" W, 55.38 feet; thence S 8°41'10" W, 45.49 feet; thence S 14°29'48" E, 48.74 feet; thence S 7°23'26" E, 74.27 feet; thence S 8°49'39" W, 10.40 feet to the North right of way line of 5th Street; thence Easterly along said North right of way line to the West right of way line of the Oregon Electric Railroad; thence Northerly along said West right of way line to the Southeast corner of Tract 'A' of said Partition Plat No. 1990-92; thence N 88°26'57" W along the South line of said Tract 'A', 494.00 feet; thence N 5°03'02" E along the West line of said Tract 'A' and the West line of Parcel 2 of said Partition Plat No. 1990-92, 178.47 feet to the point of beginning.

Contains 8.6556 acres.

The courses above are derived from a Record of Survey by Griffin Land Surveying Inc, filed in the Clackamas County Survey Records.



ZONE MAP AMMENDMENT AREA

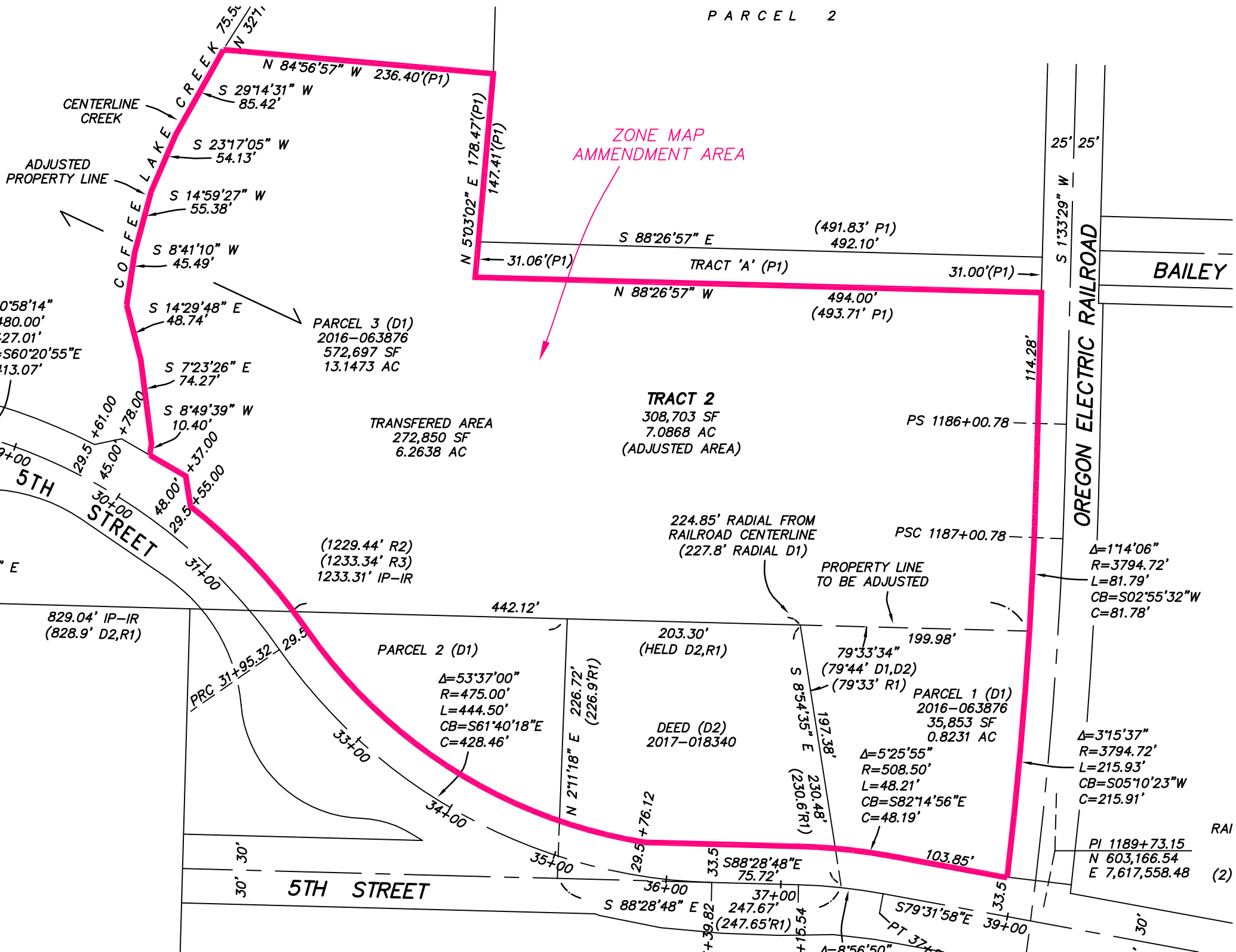

RECEIVED: _____

ACCEPTED FOR FILING: _____

SURVEY NUMBER: _____

Record of Survey

PROPERTY LINE ADJUSTMENT
WITHIN THE THOMAS BAILEY DLC 45
IN THE N.W. 1/4 OF SECTION 23, T.3S., R.1W., W.M.
CITY OF WILSONVILLE, CLACKAMAS COUNTY, OREGON,

JULY 8, 2024

FOR: INLAND PACIFIC PROPERTIES, LLLC

NARRATIVE:

THE BASIS OF BEARINGS IS THE WEST LINE OF THE THOMAS BAILEY DLC 45 PER SN 2017-241. THIS SURVEY WAS PERFORMED TO SET OUT THE BOUNDARIES OF A PROPERTY LINE ADJUSTMENT PER CITY OF WILSONVILLE PLANNING FILE NO: DB24-0001 OREPAC SITE IMPROVEMENTS.

MONUMENTS WERE HELD ALONG THE CENTERLINES OF 5TH STREET AND KINSMAN ROAD, ALONG WITH CONTROL POINTS SHOWN ON SN 2017-241 AND 2024-004 TO ESTABLISH SAID ROADS AND RIGHT OF WAY LINES. DATA WAS USED PER SAID SURVEYS, FOR THE POSITION OF MONUMENTS DESTROYED BY CONSTRUCTION.

THE SOUTH AND WEST LINES OF PARTITION PLAT NO. 1990-92 WAS ESTABLISHED BY HOLDING PLAT DATA AND THE THREE MONUMENTS ALONG SAID LINES AS SHOWN.

DATA WAS HELD PER SN 2017-241 TO ESTABLISH THE CENTERLINE AND RIGHT OF WAY LINE OF OREGON ELECTRIC RAILROAD.

ALL OF THE PROPERTIES BOUNDED BY 5TH STREET, INDUSTRIAL WAY, KINSMAN STREET, PARTITION PLAT NO. 1990-92 AND THE RAILROAD ARE OWNED BY THE SAME ENTITY. THE LINE COMMON TO PARCEL 1 (D1) AND (D2) HAVE THE SAME DIRECTION CALL (SOUTH 10°16' EAST). THE NORTH CORNER OF THE WEST LINE OF PARCEL 1 (D1) (DESCRIBED FROM THE EAST) AND EAST LINE OF (D2) (DESCRIBED FROM THE WEST) ARE IN CONFLICT. FOR THE PURPOSE OF COMPUTING AREAS FOR THIS ADJUSTMENT I HAVE HELD THE MONUMENTS AND DATA FROM THE 1960 SURVEY SN 3258 TO ESTABLISH THE LINE. FOR THE NORTH LINE I HELD THE IRON PIPE NEAR THE DLC LINE AND THE IR NEAR THE RAILROAD RIGHT OF WAY PER SN 10773 AND THE IR NEAR THE NW CORNER OF (D2). THE NE CORNER OF (D2) WAS ESTABLISHED AT DEED DISTANCE (203.30') PER THE DEED AND SN 3258. THE EAST LINE OF (D2) WAS ESTABLISHED BY HOLDING THE RRS IN 5TH STREET PER SN 3258.

THE NEW PROPERTY LINE WAS SET OUT AT THE DIRECTION OF THE CLIENT AS SHOWN. THE ADJUSTMENT DEED IS RECORDED AS DOCUMENT NO. _____, CLACKAMAS COUNTY RECORDS.

APPROVAL:

CITY OF WILSONVILLE PLANNING FILE NO:
DB24-0001 OREPAC SITE IMPROVEMENTS.

BY: _____ DATE: _____

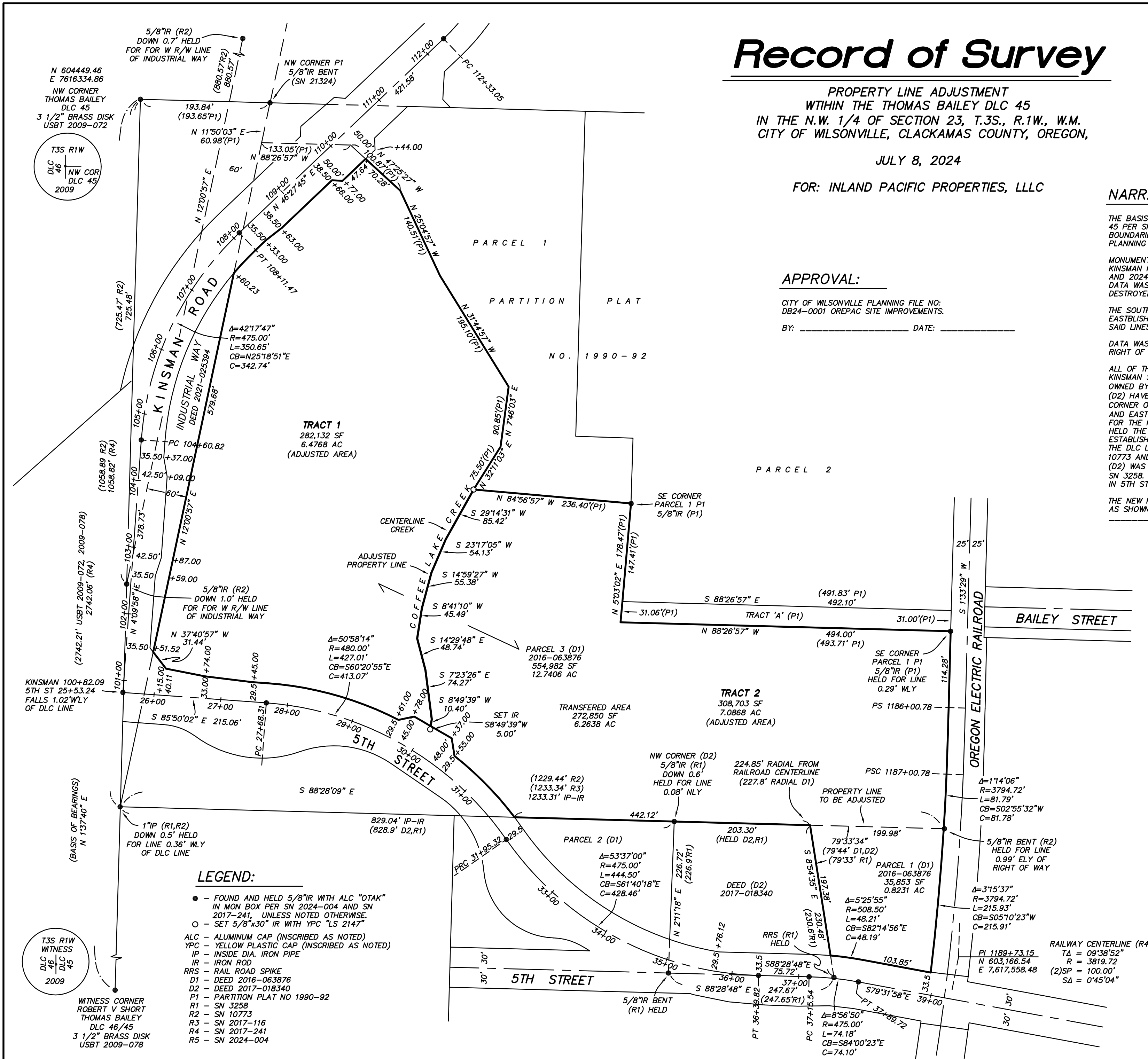

LEGEND:

- - FOUND AND HELD 5/8" IR WITH ALC "OTAK" IN MON BOX PER SN 2024-004 AND SN 2017-241, UNLESS NOTED OTHERWISE.
- - SET 5/8"x30" IR WITH YPC "LS 2147"
- ALC - ALUMINUM CAP (INSCRIBED AS NOTED)
- YPC - YELLOW PLASTIC CAP (INSCRIBED AS NOTED)
- IP - INSIDE DIA. IRON PIPE
- IR - IRON ROD
- RRS - RAIL ROAD SPIKE
- D1 - DEED 2016-063876
- D2 - DEED 2017-018340
- P1 - PARTITION PLAT NO 1990-92
- R1 - SN 3258
- R2 - SN 10773
- R3 - SN 2017-116
- R4 - SN 2017-241
- R5 - SN 2024-004

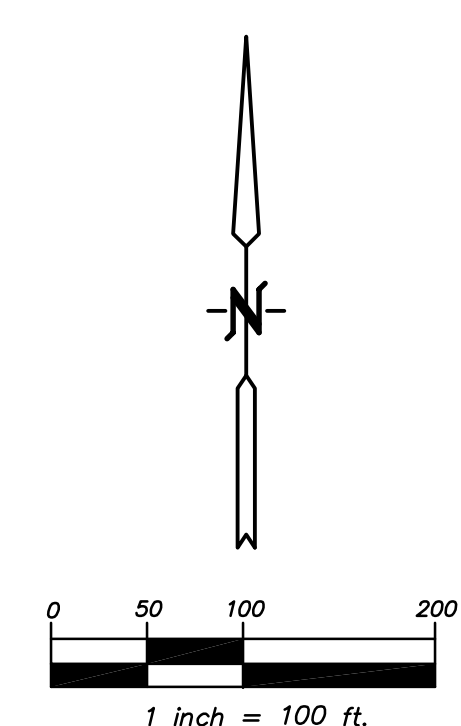

REGISTERED
PROFESSIONAL
LAND SURVEYOR

Kenneth D. Griffin

OREGON
JULY 26, 1985
KENNETH D. GRIFFIN
2147

RENEWS: 6/30/25
0864 OREPAC PLA

GRIFFIN LAND SURVEYING INC.
6107 SW MURRAY BLVD. #409
BEAVERTON, OR. 97008
PHONE: (503)201-3116

N 604449.46
E 7616334.86
NW CORNER
THOMAS BAILEY
DLC 45
3 1/2" BRASS DISK
USBT 2009-072

T3S R1W
DLC 46
NW COR
DLC 45
2009

T3S R1W
DLC 46
DLC 45
2009

WITNESS CORNER
ROBERT V SHORT
THOMAS BAILEY
DLC 46/45
3 1/2" BRASS DISK
USBT 2009-078

Exhibit 'A'

Griffin Land Surveying Inc.

6107 SW Murray Blvd. #409 – Beaverton, OR. 97008

Office: (503) 201-3116

OrePac PLA
Project: 0864

**Right of Way Vacation
Assessors Maps 31W23B
City of Wilsonville, Clackamas County, OR.**

Tract 'A', Partition Plat No. 1990-92, Clackamas County Plat Records, situated in the N.W. 1/4 of Section 23, T.3S., R.1W., W.M. in the City of Wilsonville, Clackamas County, Oregon.

Contains 15,275 square feet, more or less.



EXHIBIT B

SKETCH TO ACCOMPANY LEGAL DESCRIPTION RIGHT OF WAY VACATION MAP 3S123B CITY OF WILSONVILLE, CLACKAMAS COUNTY, OREGON

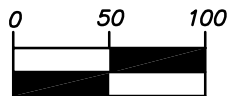
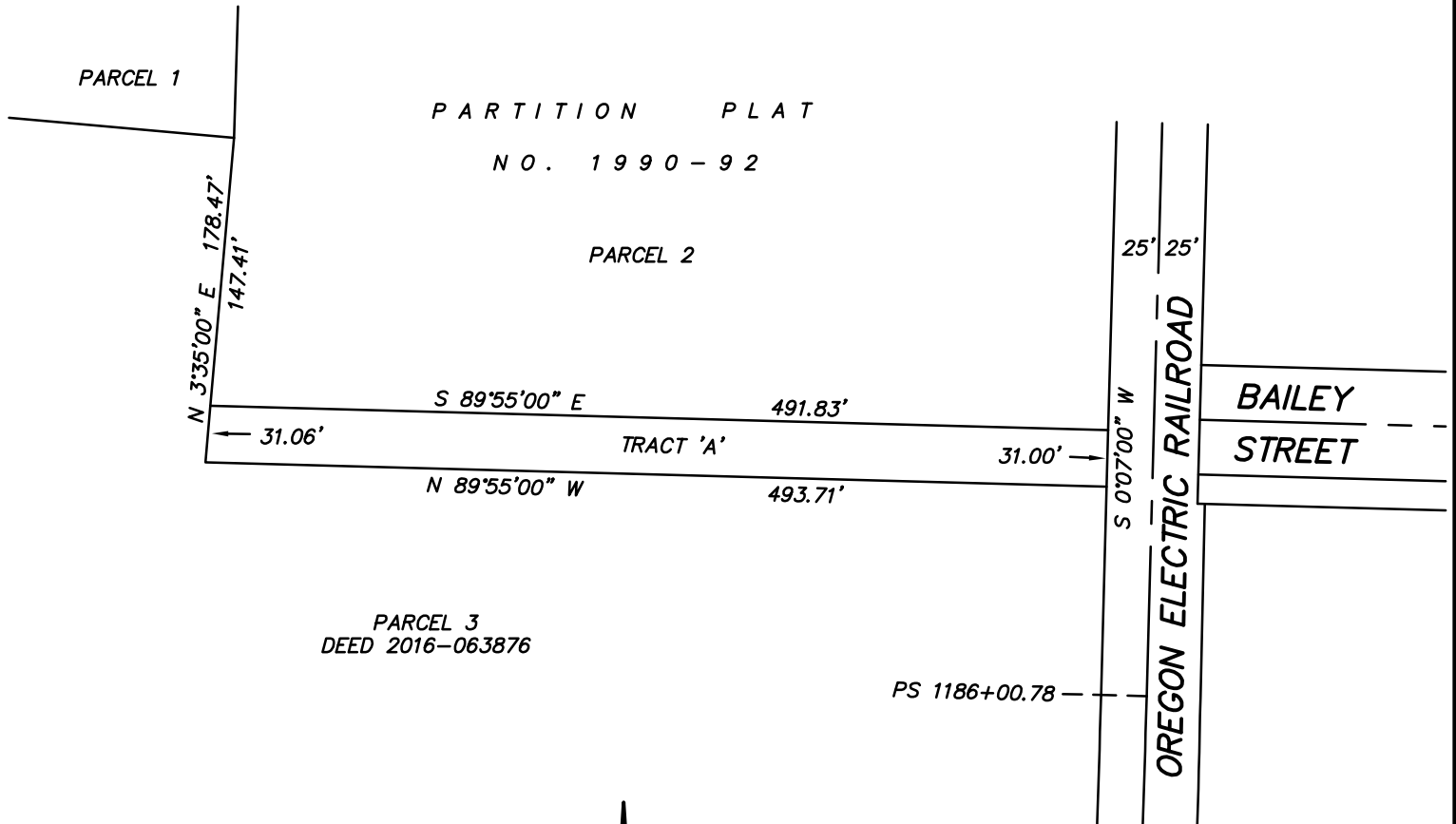

1 inch = 100 ft.

REGISTERED
PROFESSIONAL
LAND SURVEYOR

OREGON
JULY 26, 1985
KENNETH D. GRIFFIN
2147

RENEWS: 6/30/25
0864 OREPAC PLA

GRIFFIN LAND SURVEYING INC.
6107 SW MURRAY BLVD. #409
BEAVERTON, OR. 97008
(503) 201-3116

Street Vacation Petition

This petition must be signed by all abutting property owners, and the owners of not less than 2/3 of the area of the real property "affected thereby," as defined in ORS 271.080(2) and shown on the attached Street Vacation Map, attached hereto as Exhibit A. All signatures must be **in ink**. A listing of the names and addresses of all abutting and affected area property owners, as shown on the attached Street Vacation Map, was obtained from the Clackamas County real property tax roll records, and is attached hereto as Exhibit B.

REQUIRED SIGNATURES:

We, the owner in fee simple of the following described real properties consent to the vacation of Tract 'A', Partition Plat No. 1990-92, Clackamas County Plat Records, situated in the N.W. ¼ of Section 23, T.3S, R.1W., W.M. in the City of Wilsonville, Clackamas County, Oregon, as shown on the attached Street Vacation Map.

Property Owner:

Inland Pacific Properties, LLC

By: 
Bradley Hart, Manager

Property Street Address and Legal Description:

30445 SW Boones Ferry Road, Wilsonville, OR
Tax Account Nos: 31W23B 00600; 31W23B 00680; 31W23B 00690.

8-13-24
Date



TractNum	ParcelId	OwnerNameLabelFormat	OwnerNmLast	SiteAddr	SiteCity	SiteState	SiteZIP	OwnerAddr	OwnerCityNm	OwnerState	OwnerZIP
31W23B 00600	00818762	Inland Pacific Properties LLC	Inland Pacific Properties LLC	30445 SW Boonas Ferry Rd	Wilsonville	OR	97070	30170 SW Orpac Ave	Wilsonville	OR	97070
31W23B 00600	00818998	Inland Pacific Properties LLC	Inland Pacific Properties LLC		Wilsonville	OR	97070	30170 SW Orpac Ave	Wilsonville	OR	97070
31W23B 00600	00831597	Inland Pacific Properties LLC	Inland Pacific Properties LLC		Wilsonville	OR	97070	30170 SW Orpac Ave	Wilsonville	OR	97070
31W23B 00700	00818761	Inland Empire Investments LLC	Inland Empire Investments LLC	30160 SW Orpac Ave	Wilsonville	OR	97070	30170 SW Orpac Ave	Wilsonville	OR	97070
31W23B 00701	01448007	Inland Empire Investments LLC	Inland Empire Investments LLC	30170 SW Orpac Ave	Wilsonville	OR	97070	30170 SW Orpac Ave	Wilsonville	OR	97070
31W23AB01700	00818996	Proctor Driggers LLC	Proctor Driggers LLC	30289 SW Boonas Ferry Rd	Wilsonville	OR	97070	PO Box 890	Minneapolis	MIN	55440
31W23AB01701	00807200	Oregon Charter Academy	Oregon Charter Academy	30485 SW Boonas Ferry Rd	Wilsonville	OR	97070	30485 SW Boonas Ferry Rd Ste 202	Wilsonville	OR	97070
31W23AB01791	00831594	Oregon Charter Academy	Oregon Charter Academy		Wilsonville	OR	97070	30485 SW Boonas Ferry Rd Ste 202	Wilsonville	OR	97070
31W23AB01800	00819403	D Young & Lahan Dorothy	Young		Wilsonville	OR	97070	PO Box 7	Wilsonville	OR	97070
31W23AB01900	00818412	Add LLC	Add LLC	30535 SW Boonas Ferry Rd	Wilsonville	OR	97070	13282 Rogers Rd	Lake Oswego	OR	97035

STREET VACATION PETITION

This petition must be signed by all abutting property owners, and the owners of not less than 2/3 of the area of the real property "affected thereby," as defined in ORS 271.080(2) and shown on the attached Street Vacation Map, attached hereto as Exhibit A. All signatures must be **in ink**. A listing of the names and addresses of all abutting and affected area property owners, as shown on the attached Street Vacation Map, was obtained from the Clackamas County real property tax roll records, and is attached hereto as Exhibit B.

REQUIRED SIGNATURES:

We, the owner in fee simple of the following described real properties consent to the vacation of Tract 'A', Partition Plat No. 1990-92, Clackamas County Plat Records, situated in the N.W. ¼ of Section 23, T.3S, R.1W., W.M. in the City of Wilsonville, Clackamas County, Oregon, as shown on the attached Street Vacation Map.

Property Owner:

Inland Empire Investments, LLC

By: Bradley Hart
Bradley Hart, Manager

Property Street Address and Legal Description:

30160 SW Orepac Ave, Wilsonville, OR
30170 SW Orepac Ave, Wilsonville, OR
Tax Account Nos: 31W23B 00700; 31W23B 00701.
Parcel IDs: 00818761; 01449007.

8-13-24
Date

TaxAcctNum	ParcelId	OwnerNameLabelFormat	OwnerNmLast	SiteAddr	SiteCity	SiteState	SiteZIP	OwnerAddr	OwnerCityNm	OwnerState	OwnerZIP
31W238 00600	00818792	Inland Pacific Properties LLC	Inland Pacific Properties LLC	30448 SW Boones Ferry Rd	Wilsonville	OR	97070	30170 SW Crepac Ave	Wilsonville	OR	97070
31W238 00680	05031898	Inland Pacific Properties LLC	Inland Pacific Properties LLC		Wilsonville	OR	97070	30170 SW Crepac Ave	Wilsonville	OR	97070
31W238 00690	05031597	Inland Pacific Properties LLC	Inland Pacific Properties LLC		Wilsonville	OR	97070	30170 SW Crepac Ave	Wilsonville	OR	97070
31W238 00700	00818781	Inland Empire Investments LLC	Inland Empire Investments LLC	30180 SW Crepac Ave	Wilsonville	OR	97070	30170 SW Crepac Ave	Wilsonville	OR	97070
31W238 00701	01449007	Inland Empire Investments LLC	Inland Empire Investments LLC	30170 SW Crepac Ave	Wilsonville	OR	97070	30170 SW Crepac Ave	Wilsonville	OR	97070
31W238A01700	00819386	Proctor Driggers LLC	Proctor Driggers LLC	30298 SW Boones Ferry Rd	Wilsonville	OR	97070	PO Box 950	Minneapolis	MIN	55440
31W238A01701	05007300	Oregon Charter Academy	Oregon Charter Academy	30485 SW Boones Ferry Rd	Wilsonville	OR	97070	30485 SW Boones Ferry Rd Ste 202	Wilsonville	OR	97070
31W238A01791	05031894	Oregon Charter Academy	Oregon Charter Academy		Wilsonville	OR	97070	30485 SW Boones Ferry Rd Ste 202	Wilsonville	OR	97070
31W238A01800	00819403	O Young & Lohan Dorothy	Young		Wilsonville	OR	97070	PO Box 7	Wilsonville	OR	97070
31W238A01900	00819412	ADD LLC	ADD LLC	30535 SW Boones Ferry Rd	Wilsonville	OR	97070	13292 Rogers Rd	Lake Oswego	OR	97035



STREET VACATION PETITION

This petition must be signed by all abutting property owners, and the owners of not less than 2/3 of the area of the real property "affected thereby," as defined in ORS 271.080(2) and shown on the attached Street Vacation Map, attached hereto as Exhibit A. All signatures must be **in ink**. A listing of the names and addresses of all abutting and affected area property owners, as shown on the attached Street Vacation Map, was obtained from the Clackamas County real property tax roll records, and is attached hereto as Exhibit B.

REQUIRED SIGNATURES:

We, the owner in fee simple of the following described real properties consent to the vacation of Tract 'A', Partition Plat No. 1990-92, Clackamas County Plat Records, situated in the N.W. ¼ of Section 23, T.3S, R.1W., W.M. in the City of Wilsonville, Clackamas County, Oregon, as shown on the attached Street Vacation Map.

Property Owner:

Oregon Electric Railroad

By: 

By: Jennifer Sellers (Aug 15, 2024 22:46 CDT)

Print Name: Jennifer Sellers

Print Title: Multimodal and Rail Services Unit Manager - Oregon Department of Transportation

Property Address and Legal Description:

Oregon Electric Railroad

08/15/2024

Date

TaxAcctNum	ParcelId	OwnerNameLabelFormat	OwnerNmLast	SiteAddr	SiteCity	SiteState	SiteZIP	OwnerAddr	OwnerCityNm	OwnerState	OwnerZIP
31W23B 00600	00818752	Inland Pacific Properties LLC	Inland Pacific Properties LLC	30445 SW Boones Ferry Rd	Wilsonville	OR	97070	30170 SW Orepac Ave	Wilsonville	OR	97070
31W23B 00680	05031598	Inland Pacific Properties LLC	Inland Pacific Properties LLC		Wilsonville	OR	97070	30170 SW Orepac Ave	Wilsonville	OR	97070
31W23B 00690	05031597	Inland Pacific Properties LLC	Inland Pacific Properties LLC		Wilsonville	OR	97070	30170 SW Orepac Ave	Wilsonville	OR	97070
31W23B 00700	00818751	Inland Empire Investments LLC	Inland Empire Investments LLC	30160 SW Orepac Ave	Wilsonville	OR	97070	30170 SW Orepac Ave	Wilsonville	OR	97070
31W23B 00701	01449007	Inland Empire Investments LLC	Inland Empire Investments LLC	30170 SW Orepac Ave	Wilsonville	OR	97070	30170 SW Orepac Ave	Wilsonville	OR	97070
31W23AB01700	00819396	Proctor Driggers LLC	Proctor Driggers LLC	30299 SW Boones Ferry Rd	Wilsonville	OR	97070	PO Box 950	Minneapolis	MN	55440
31W23AB01701	05007200	Oregon Charter Academy	Oregon Charter Academy	30485 SW Boones Ferry Rd	Wilsonville	OR	97070	30485 SW Boones Ferry Rd Ste 202	Wilsonville	OR	97070
31W23AB01791	05031594	Oregon Charter Academy	Oregon Charter Academy		Wilsonville	OR	97070	30485 SW Boones Ferry Rd Ste 202	Wilsonville	OR	97070
31W23AB01800	00819403	D Young & Lehan Dorothy	Young		Wilsonville	OR	97070	PO Box 7	Wilsonville	OR	97070
31W23AB01900	00819412	Ado LLC	Ado LLC	30535 SW Boones Ferry Rd	Wilsonville	OR	97070	13292 Rogers Rd	Lake Oswego	OR	97035





**Department of Energy
Bonneville Power Administration
2715 Tepper Lane NE
Keizer, OR 97303**

July 8, 2024

In reply refer to: TERR

BPA Case No.: 20240269
Tract No(s): OC-S-33-A-14 & V-E-31-A-500
Line Name(s): Vancouver-Eugene (Operating as Oregon City-Chemawa No. 2)
ADNO(s): 7254
Location: Str. No(s): 3/6-3/10

LAND USE AGREEMENT
Consent to Use of BPA's Easement Area

This Land Use Agreement ("Agreement") is entered into by and between the United States of America, Department of Energy, Bonneville Power Administration ("BPA") and Inland Pacific Properties, LLC ("Holder").

BPA holds easement rights ("BPA Easement") over the following described property ("BPA Easement Area"):

A portion of the Thomas Bailey DLC No. 45 in Section 23, Township 3 South, Range 1 West, Willamette Meridian, Clackamas County, State of Oregon, as shown on the attached segment of BPA Drawing No. 12605, marked as Exhibit A.

Holder has requested BPA's permission to use portions of the real property subject to the BPA Easement Area to install an asphalt driveway/roadway, create a swale and run a 23 inch storm water pvc pipe which will be buried 18 inches. ("Holder's Facility").

Subject to the terms and conditions set forth in this Agreement, BPA consents to Holder's use of the BPA Easement Area for the purpose proposed by Holder, and concurs that such use will not interfere with the current operation and maintenance of BPA's transmission facilities, if constructed in the manner and at the location shown on Exhibit A, attached hereto and made a part hereof.

In consideration of BPA's concurrence, Holder agrees to the following:



1. This Agreement does not grant any right, privilege, or interest in land, and does not modify, change, or otherwise alter the rights BPA acquired by deed. Loss of the privileges granted by this Agreement is not compensable to Holder.
2. Holder is responsible for obtaining from the underlying landowner ("Landowner"), by good and sufficient legal instrument, all rights, interests and privileges for land use necessary and incident to the ownership and maintenance of Holder's Facility.

3. There may be other uses of the property located within the same area as Holder's Facility. This Agreement is subject to such superior rights.
4. This Agreement is valid only if Holder's Facility is constructed, operated, and maintained in conformance with the terms of this Agreement and all attached Exhibits. Relocations, changes or upgrades require BPA's prior written approval. Failure to obtain the written approval of BPA prior to making alterations to Holder's Facility shall result in the termination of this Agreement.
5. Holder acknowledges and agrees that Holder's use of the property is subordinate to BPA's easement rights. BPA reserves the right to trim or remove trees, brush or shrubs or to remove any other encroachment within the BPA Easement Area which might interfere with the operation, maintenance, construction, removal or relocation of BPA's facilities. Holder agrees to alter, relocate or remove Holder's Facility, at no cost to BPA, to correct an interference with BPA's easement rights or to accommodate future modifications of BPA's facilities.
6. Holder agrees to abide by and comply with all applicable Federal, State and local laws and regulations, including, but not limited to building and safety codes, rules issued by utility commissions, the National Electric Safety Code, entities that regulate Holder, and all applicable environmental regulations.
7. Induced voltages and currents may occur on structures or other items constructed or placed under or near high voltage transmission lines. BPA has no duty to inspect Holder's Facility or to warn of hazards. Holder shall have the continuing responsibility for the protection of personnel and equipment in the design, construction, operation and maintenance of Holder's Facility.
8. Holder shall notify BPA at least ten (10) business days prior to commencing installation of Holder's Facility. Contact: Darin Smith, phone: 503-304-5906 or by email: dxsmith@bpa.gov.
9. This Agreement is entered into with the express understanding that it is not assignable or transferable to other parties without the prior written consent of BPA.
10. BPA may terminate this Agreement upon 30 days written notice. Holder shall, within 30 days of receiving such notice of termination, and at Holder's sole expense, vacate and restore the BPA Easement Area to a condition satisfactory to BPA. Upon Holder's failure to vacate and restore the BPA Easement Area within the above stated time period, BPA may remove Holder's Facility and restore the BPA Easement Area at Holder's expense.
11. A copy of this Agreement shall be physically located at Holder's project site during construction activities. Holder's employees, contractors and representatives shall adhere to all conditions and requirements listed herein.
12. Additional terms and conditions specific to Holder's Facility may be included as part of this Agreement as Exhibit B, attached hereto and made a part hereof.
13. Holder agrees to assume risk of loss, damage, or injury which may result from Holder's use of the BPA Easement Area, except for such loss, damage, or injury for which BPA may be responsible under the provisions of the Federal Tort Claims Act, 62 Stat. 982, as amended.

14. Any damage to BPA's property caused by or resulting from Holder's use of the BPA Easement Area may be repaired by BPA, and the actual cost of such repair shall be charged against and be paid by Holder.

15. Holder's contact information:

NAME: Inland Pacific Properties, LLC
ADDRESS: 30170 SW Orepac Avenue
Wilsonville, OR 97070

PHONE: 
EMAIL: 

Holder agrees to notify BPA in writing of any changes to the above listed contact information.

This Agreement becomes effective upon the signature of all parties.

Holder

Date

Print Name

Title (if applicable)

THIS AGREEMENT IS HEREBY AUTHORIZED:

Darin Smith
Realty Specialist
Bonneville Power Administration

Date

NOTE: Execution in Counterparts; Electronic Signature; Electronic Transmittal. This Land Use Agreement may be executed in counterparts, each of which will be deemed an original, but all of which constitute one and the same instrument. Electronic or digital signatures shall be deemed original signatures for purposes of this Land Use Agreement. Said counterparts may also be transmitted by one Party to the other by facsimile or electronic mail.

BPA seeks help maintaining the integrity of the electrical transmission system. Please report any vandalism or theft to the BPA Crime Witness program at 1-800-437-2744. Cash rewards of up to \$25,000 will be paid should information lead to the arrest and conviction of persons committing a crime.

If you have any questions or concerns, please notify a BPA Realty Office. You may contact Darin Smith (“BPA Representative”) by telephone at 503-304-5906 or send written correspondence to the address listed at the top of this Agreement.

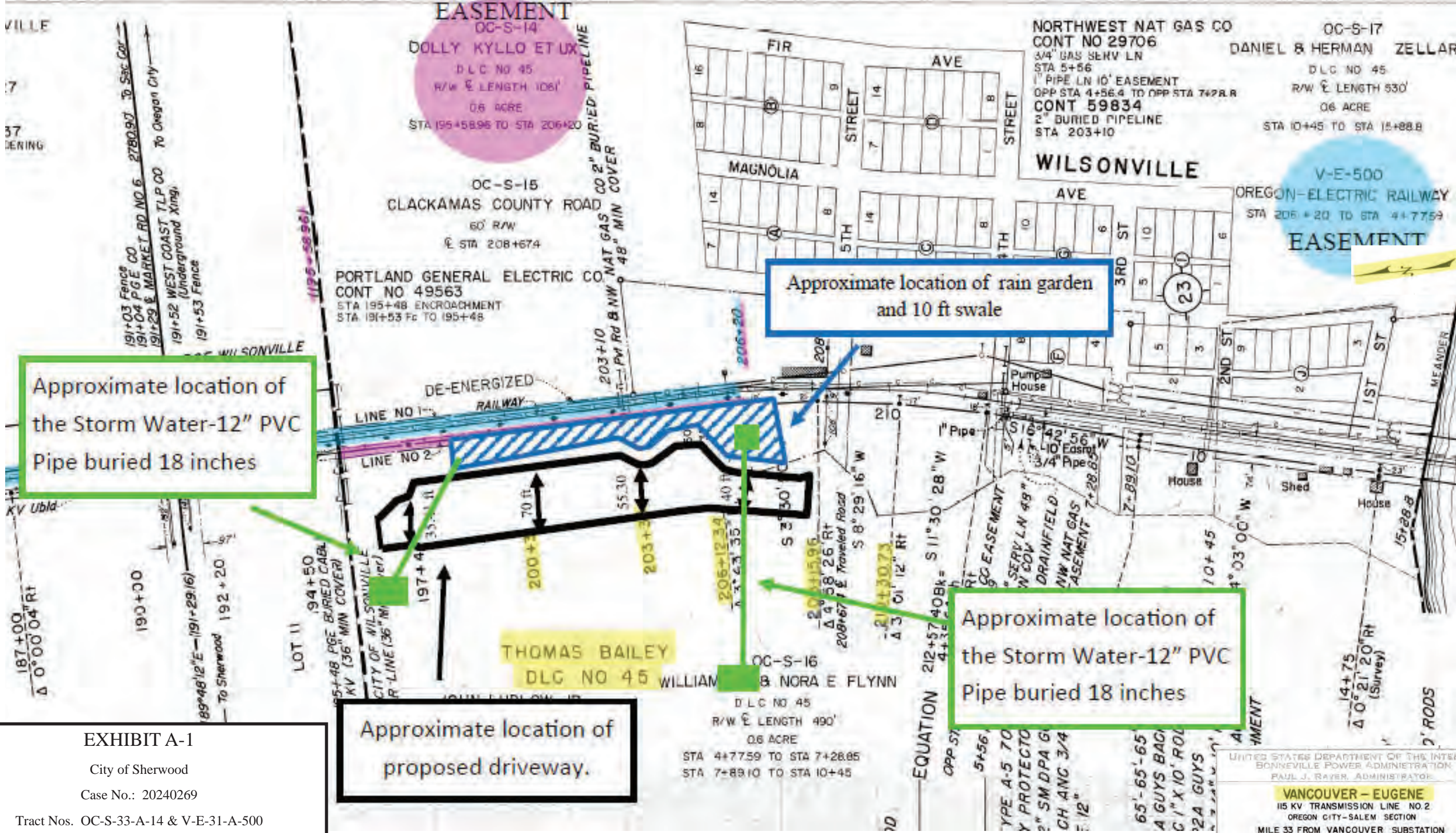

Approximate location of the Storm Water-12" PVC Pipe buried 18 inches

Approximate location of rain garden and 10 ft swale

Approximate location of the Storm Water-12" PVC Pipe buried 18 inches

Approximate location of proposed driveway.

EXHIBIT A-1
 City of Sherwood
 Case No.: 20240269
 Tract Nos. OC-S-33-A-14 & V-E-31-A-500
 Legal Description: A portion of the Thomas Bailey DLC No. 45 in Section 23, Township 3 South, Range 1 West, Willamette Meridian, County of Clackamas and State of Oregon.

Case No. 20240269

UNITED STATES DEPARTMENT OF THE INTERIOR
 BONNEVILLE POWER ADMINISTRATION
 PAUL J. RAYER, ADMINISTRATOR

VANCOUVER - EUGENE
 115 KV TRANSMISSION LINE NO. 2
 OREGON CITY - SALEM SECTION
 MILE 33 FROM VANCOUVER SUBSTATION
 CLACKAMAS COUNTY, OREGON

SEC 14 B 23 T 3 S RIW WM

Surveyor: *Allan Lasker*
 Engineer: *Eugene L. White*
 Date: 8-2-21

Scale of L.L.C. 6-21-41
 SERIAL NO. 12605
 C 112-345-D2
 57-NO. 24

OPERATED AS MILE 3 OREGON CITY-CHEMAWA NO. 2

EXHIBIT B
ADDITIONAL TERMS AND CONDITIONS

1. All uses of the right-of-way shall meet local/state/federal/national codes.
2. General Uses and Pipelines shall maintain a minimum horizontal clearance of **50** feet to the point where steel lattice tower legs, steel poles, concrete poles and concrete foundations enter the earth. A horizontal clearance of **25** feet to the point where wood poles and guy anchors enter the earth shall also be maintained, except as approved by BPA and shown on Exhibit(s).
3. Holder shall not obstruct access to BPA's Easement Area or transmission line system. BPA personnel and/or its contractors must have access all times.
4. Construction equipment shall maintain a minimum distance of **15** between the equipment and transmission line conductors at all times. Do not measure this with measuring tape, pole or other physical means. If there is the possibility that any equipment can encroach on this distance, then a safety watcher will be required.
5. BPA right-of-way and access roads shall be returned to their original condition following construction. No grade changes to facilitate construction or disposal of overburden shall be allowed. Any damage to BPA property resulting from the proposed right-of-way or access road use shall be repaired at the applicant's expense.
6. Holder shall not store flammable materials or refuel vehicles or equipment on BPA's Easement Area.
7. Notice: Nuisance shocks may occur on BPA's Easement Area. Grounding metal objects helps to reduce the level of shock. It is suggested that road building/construction equipment be grounded with a drag chain.
8. Any portion of Holder's Facility constructed on BPA's Easement Area shall be designed and built to withstand HL-93 loading for BPA's heavy vehicles.
9. Install gate(s) in Holder's fence of not less than 16-feet in width for the passage of BPA vehicles. The approved location of the gate(s) is (are) as shown on attached Exhibit(s) A. Gate(s) may be locked, provided a BPA lock is also included in the locking mechanism.

PIPELINES

10. The pipeline is approved at the location shown on the enclosed plan July 3, 2024.
11. Bury and maintain the PVC pipeline to a depth of **18** inches or comply with applicable NESC, national, state, and/or local standards, whichever is greater.
12. Mark the location of the underground PVC pipeline with permanent signs and maintain such signs where they enter and leave BPA's Easement Area, and at any angle points within BPA's Easement Area.